

ELECTRONIC INDUSTRIES

A CHILTON PUBLICATION

The S-Plane

In Filter Design

(See page 98)

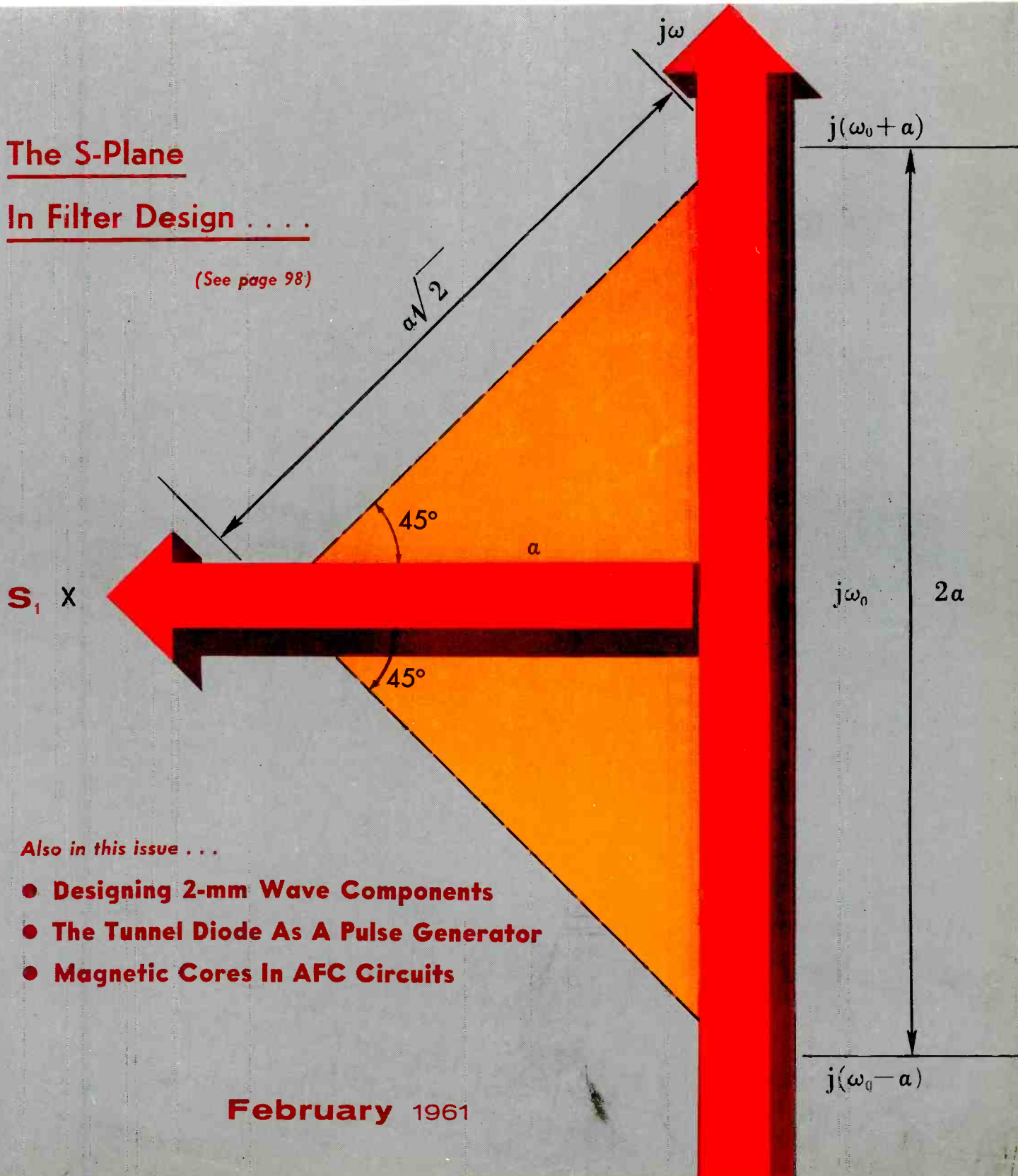

Also in this issue . . .

- Designing 2-mm Wave Components
- The Tunnel Diode As A Pulse Generator
- Magnetic Cores In AFC Circuits

February 1961

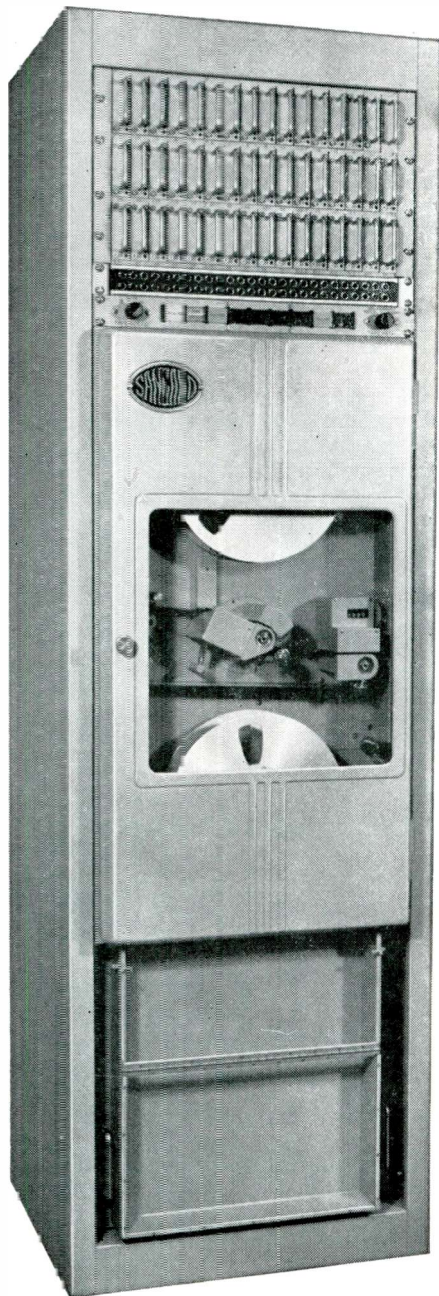

*superior
accuracy
and
reproducibility
with the*

SANGAMO 460-SERIES TAPE TRANSPORT

The Sangamo 460-Series is a fully transistorized magnetic tape Recorder/Reproducer for application in direct analog, wideband FM, PDM, and PCM instrumentation systems.

➤ Magnetic tape instrumentation system accuracies heretofore considered unattainable have been achieved by Sangamo as a result of reduced instantaneous and long-term record-playback speed deviations. The 460-Series Tape Transport accomplishes this by combining a very low inertia D. C. capstan drive with a high-response, tape-speed, servo control system.

➤ A unique vacuum tension/cleaning pad located immediately in front of the recording or reproducing head provides gentle, but firm and precise, tape tension. The head in turn is mounted almost in contact with the drive capstan. This arrangement results in a very short span of tape that requires controlled positioning. The combination of these features results in minimum skew, less flutter, and fewer dropouts.

➤ Additional features of the Sangamo 460-Series Tape Transport are: Reel-to-reel or loop operation with the same machine • Ability to handle all tapes, from 1/4" to 2" in width, 1.0 to 1.5 mil base • All D. C. drives • Fully transistorized •

Sangamo 460-Series Magnetic Tape Record/Reproduce systems are sold through technically qualified Sangamo agents specially selected for their ability to assist you in magnetic tape instrumentation applications. In addition, Sangamo Application Engineers are available to provide further technical assistance wherever necessary. For complete details on the Sangamo 460-Series Record/Reproduce system, write for Bulletin H-460A or contact your nearest Sangamo representative.

BROGAN ASSOCIATES, INC.
Mineola, L. I., New York
Chestnut Hill, Mass.

DATRONICS, INCORPORATED
Houston, Texas
Dallas, Texas

J. E. CUESTA COMPANY
Paoli, Pa.
Washington, D. C.

MEDCO, INCORPORATED
Melbourne, Florida
Huntsville, Ala.

PERLMUTH ELECTRONIC ASSOCIATES
Los Angeles 16, California
San Diego, California
Palo Alto, California

SANGAMO 460-SERIES PERFORMANCE CHARACTERISTICS:

START TIME: 1.0 second max. to synchronization with servo speed control at 60 ips up to 1" wide tape.

STOP TIME: 0.2 seconds max. from 60 ips.

INSTANTANEOUS TIME DISPLACEMENT ERROR: 25.0 microseconds max. at 60 ips.

LONG-TERM TIME DISPLACEMENT ERROR: ±0.01% max.

INTER-CHANNEL TIME DISPLACEMENT ERROR: ±2.0 microseconds at 60 ips between outside tracks on 1" tape.

SERVO SPEED CONTROL RANGE: ±15% nominal tape speed.

SERVO RESPONSE: ±15% speed change per second.



SANGAMO ELECTRIC COMPANY

SPRINGFIELD, ILLINOIS

Circle 1 on Inquiry Card

SC60-9

ELECTRONIC INDUSTRIES

ROBERT E. McKENNA, Publisher

• BERNARD F. OSBAHR, Editor

First Order Of Business

HIGHLIGHT of the recent Seventh National Symposium on Reliability and Quality Control in Philadelphia was a special round table discussion. Moderated by W. A. MacDonald, Chairman of the Board of Hazeltine Corporation, a panel discussed "Do present government procurement practices promote delivery of unreliable equipment." The audience also participated. From this meeting we conclude that there is a rather serious breakdown in communications between industry, military customer, the congress and the public. The breakdown develops as a result of "Interpretation of the intent of the written word."

In the past decade government procurement practices have become much more sophisticated and greatly refined. It is argued that the type of contract now in use carries out the will of the congress. Competitive bid contracts tend to assure widest possible source participation at the lowest possible cost to the taxpayer. Other types of contracts are issued when, for technical reasons, the competitive bid type contract would be impractical. Typical are contracts designed to permit the manufacture of the product on a cost plus fixed fee basis. Contracts can also involve an incentive clause which provides for a higher return to the contractor effecting substantial manufacturing cost reduction. All in all, it is argued, the various type procurement contracts now in use can provide for all special situations and do carry out the will and the intent of the congress—to provide the best possible product at the lowest price on as wide a manufacturing source base as possible. On the surface this sounds good, but in practice . . .

Industry claims that present procurement practices fall far short of the desired objective. There are accusations that present procedures actually work to the detriment of small business; that they promote small business into larger organizations which in turn tend to monopolize military business. That proprietary product and patent positions developed by manufacturers

in performance of a contract are literally usurped by the government. That manufacturers are forced to reveal their productive know-how and that this information is then made available to a lower competitive bidder.

That the competitive bid system encourages purchase of low initial cost equipment and that such equipment in the field can become a real albatross so far as maintainability is concerned.

When we add the subject of reliability to the procurement practices situation, the picture becomes even more clouded. It is difficult to get across a concept that greater built-in reliability costs more money. The military find difficulty in explaining this to the congress. Things really compound themselves when a congressman attempts to justify this to the taxpayer.

One has to recognize that military electronic systems are essentially custom electronic systems. It takes a great deal of technological development, testing, and time to advance reliability in customs systems. To illustrate this, take a look at the great improvements in TV broadcasting over the past decade. Then remember that TV is not a custom system . . . It is a mass consumer system designed to function indefinitely. This factor makes it possible to build reliability on past reliability, to improve products and to reduce costs on a year by year basis. With military systems, this is just not possible. Equipment quantities are too small. Defense requirements change and obsolete systems rapidly.

It looks as if the time has come for all interested parties—"Industry, Military and Government, Congress and any appropriate Citizens' representative" to get together and communicate. As this issue is published our new President will be inaugurated. Mr. Kennedy has made Mr. Robert S. McNamara Secretary of Defense. As a first order of business, we should like to suggest the review and modification of present government procurement practices to more effectively couple the ideal views of the congress with the prevailing practical situations in business and industry.

ROBERT E. McKENNA, Publisher
BERNARD F. OSBAHR, Editor

CREIGHTON M. MARCOTT
Managing Editor
RICHARD G. STRANIX
JOHN E. HICKEY, Jr.
CHRISTOPHER CELENT
Associate Editors
DR. ALBERT F. MURRAY
Contributing Editor
ROLAND C. DAVIES
Washington News
MARIE T. McBRIDE
Directory Editor
ELMER KETTERER
Art Editor
IDA M. GOOD
Editorial Secretary
MAE E. MOYER
Readers' Service

EDITORIAL CORRESPONDENTS

Washington—1093 National Press Bldg.
GEORGE BAKER
NEIL R. REGEIMBAL
DAVID R. HEIMLY

BUSINESS DEPARTMENT

ELMER DALTON
Circulation Manager
DONALD J. MORAN
Marketing Manager
GORDON HERNDON
Production Manager

REGIONAL SALES MANAGERS

Philadelphia (39)—56th & Chestnut Sts.
SHERWOOD 8-2200
JOSEPH DRUCKER

New York (17)—100 East 42nd St.
OXford 7-3400

GERALD B. PELISSIER
Metropolitan N. Y.
MENARD DOSWELL III
New England

Chicago (1)—360 N. Michigan Ave.
RAnDolph 6-2166
GEORGE H. FELT

Cleveland (15)—930 Keith Bldg.
SUperior 1-2860
SHELBY A. McMILLION

Los Angeles (57)—198 S. Alvarado St.
DUnkirk 7-4337
B. WESLEY OLSON

San Francisco (3)—1355 Market St.
UNDerhill 1-7107
DON MAY

Atlanta (3)—911 William-Oliver Bldg.
JACKson 3-6791
JOHN W. SANGSTON

Dallas (6)—Meadows Bldg., Expressway
at Milton
EMerson 8-4751
HAROLD E. MOTT

London, S.W. (1)—67/68 Jermyn St.
St. James'
Dusseldorf—Hüttenstrasse 17
Am Ernst-Reuter-Platz
MAX F. HOLSINGER

JOHN H. KOPRON
Chilton Research Director

G. C. BUZBY, President

Vice Presidents: P. M. Fahrendorf
Leonard V. Rawlands, George T.
Hook, Robert E. McKenna; Treasurer
William H. Vailor; Secretary, James
A. Montgomery; Directors: Maurice
E. Cox, Frank P. Tighe, Everit B. Ter-
hune, Jr., Russell W. Case, Jr.,
Charles A. S. Heinle, John H. Kotron,
George E. Cameron. Washington
member of the Editorial Board, Paul
Wooton.

Comptroller, Stanley Appleby.

Cable Address—"CHILTON PHILADELPHIA"

ELECTRONIC INDUSTRIES, February, 1961. Vol. 20, No. 2. A monthly publication of Chilton Company. Executive, Editorial & Advertising offices at Chestnut & 56th Sts., Phila. 39, Pa. Accepted as controlled circulation publication at Phila., Pa. \$1 a copy; Directory issue (June), \$5.00 a copy. Subscription rates U. S. and U. S. Possessions: 1 yr. \$10.00; 2 yrs. \$18.00. Canada 1 year, \$12.00; 2 yrs. \$20.00. All other countries 1 yr. \$16.00; 2 yrs. \$30.00. Copyright 1961 by Chilton Company. Title Reg. U. S. Pat. Off. Reproduction or reprinting prohibited except by written authorization.

ELECTRONIC INDUSTRIES

Vol. 20, No. 2

February, 1961

MONTHLY NEWS ROUND-UP

Radarscope: What's Ahead for the Electronic Industries . . .	4
As We Go To Press	7
Electronic Shorts	8
Coming Events	10
Electronic Industries' News Briefs	23
TOTALS: Late Marketing Statistics	25
Snapshots . . . of the Electronic Industries	28
International News	33
Next Month in "Electronic Industries"	89
Washington News	206

<i>Editorial: First Order of Business</i>	1
<i>Designing 2-MM Wave Components</i> L. L. Bertan	90
<i>Using Insertion Parameters for Filter Design</i> H. J. Kammin	95
<i>S-Plane Aids Filter Design</i> J. J. Jones	98
<i>Understanding Silicon Photocells</i> Werner Luft	102
<i>The Tunnel Diode as a Pulse Generator</i> P. Mauch	106
<i>Nomograph for Potentiometer Loading</i> J. J. O'Connor	108
<i>What's New</i>	110
<i>Power Regulator for BWO Sweep Generators</i> R. B. Mosley	112
<i>Controlling with Magnetic Cores</i> M. Cooperman	116
<i>Designing a Lightweight Vibration Transducer (Pt. II)</i> T. D. Smith & H. R. Spence	120
<i>Simple Delay Line Clock</i> R. M. Sonkin	126
<i>International Electronic Sources</i>	185
<i>Electronic Operations</i>	199
<i>Transistorized FM Wireless Mike</i> S. J. Lanzalotti	200
<i>Professional Opportunities</i>	211
<i>Writing—Key to Your Engineering Development</i>	212

NEW PRODUCTS & TECH DATA

New Technical Data for Engineers	128
New Products	134

DEPARTMENTS

Tele-Tips	38	System-Wise	199
Letters	42	Cues for Broadcasters	204
Books	55	News of Mfrs. Representatives	216
Personals	80	Industry News	220



Highlights

of this issue

Designing 2-Millimeter Wave Components page 90

Lack of a self-excited coherent source of millimeter power has led to the design of crystal harmonic generators. Sufficient signal has been obtained for construction and calibration of several components. Novel design and construction technique are described here which overcome restrictions of TE₁₀ rectangular waveguide.

Using Insertion Parameters for Filter Design page 95

Computer availability has increased the use of insertion-parameter methods in the design of LC filters. The development of these methods for crystal filter design has been lagging. This article shows how to apply these techniques to the design of improved single sideband crystal filters.

S-Plane Aids Filter Design page 98

The complex frequency plane, better known as the S-plane, plays an important role in modern circuit theory and related fields. This article shows its usefulness in designing single-tuned filters.

Understanding Silicon Photocells page 102

Silicon photocells offer a number of advantages in data processing equipment and for low-light-level sensing operations. However, for various reasons, design engineers are often uncertain about how to use these devices. Here the photocell characteristics are analyzed and explained.

The Tunnel Diode as a Pulse Generator page 106

After graphically analyzing the tunnel diode's action as a square wave generator, this article synthesizes a pulse generator which exploits the device's ability to switch more rapidly through the peak, rather than valley, current region.

Nomograph for Potentiometer Loading page 108

Most nomographs for potentiometer loading assume that a known voltage is applied to the potentiometer. This article describes the increasingly important case when a known current is used. The nomograph gives the numerical value of the loading error so that the output can be corrected.

Controlling With Magnetic Cores page 116

Theory, confirmed by experiment, indicates that magnetic memory techniques may be employed to provide features unobtainable with conventional AFC and APC systems. Though still experimental, the techniques are presented here.

Transistorized FM Wireless Mike page 200

A simple wireless microphone that transmits on the FM broadcast band operates surprisingly well. Complete details for constructing the compact unit are given along with design information for making changes to suit the user's application.

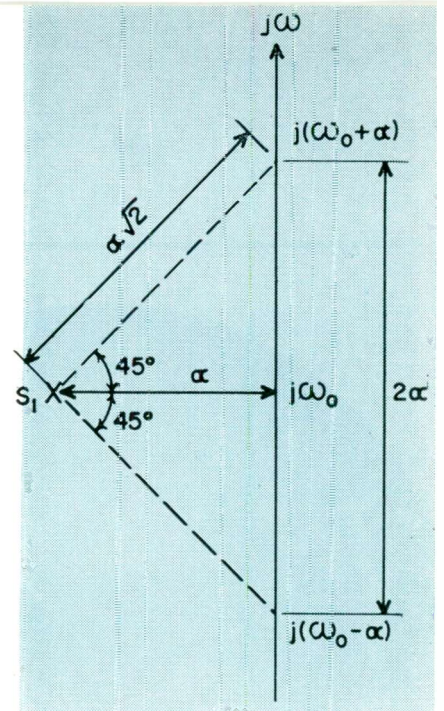

S-Plane

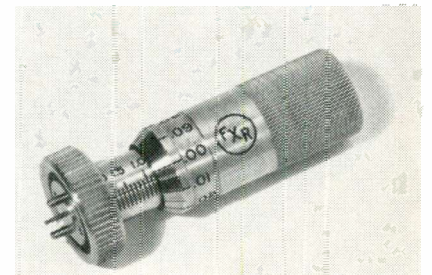

2-MM Wave Components

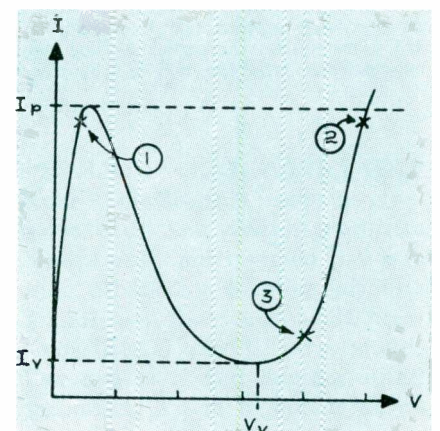

The Tunnel Diode

Silicon Photocells

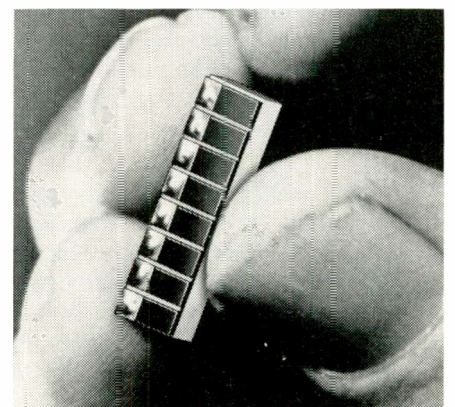

RADARSCOPE

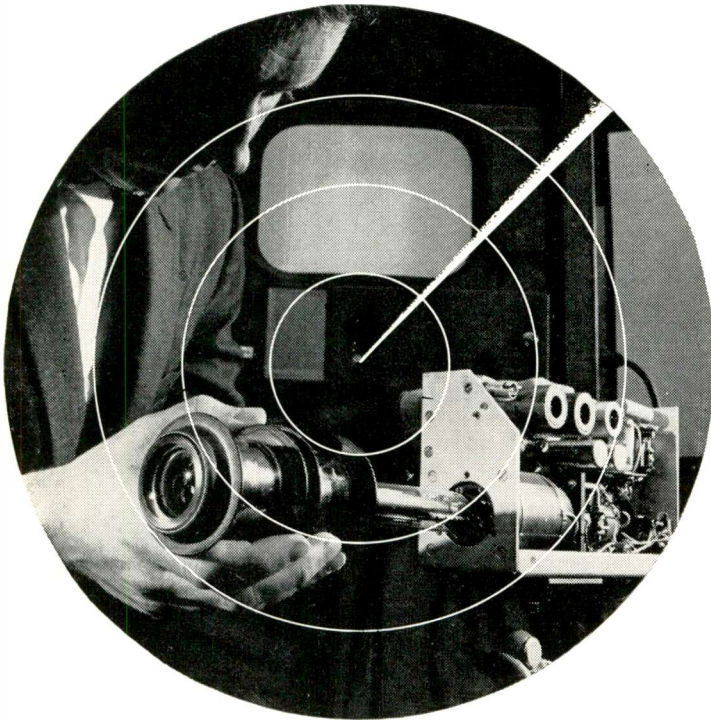

FOR SPACE TELESCOPE

New electronic imaging tube, the Uvicon, is installed in a TV camera at Westinghouse research labs by physicist A. E. Anderson. Operating on ultraviolet radiation that is normally screened by the atmosphere and never reaches the earth's surface, the new tube is the heart of an electronic telescope that will be placed in orbit in a satellite.

THE IMPENDING NUCLEAR STALEMATE, that may, in some high official's view, make a world-war an impossibility, may turn scientific efforts to new areas of competition. The area opened by computers and the field of automatic control seems likely to yield the most ready results. The exact form that this effort will take is still somewhat nebulous, and philosophical, but it is generally understood to be an extension of man's reasoning ability.

MISSILE DATA has been recorded and analyzed during the missile flight. Data is usually not available for many days after completion of a missile flight. The Ortholog analyzer—developed by Gulston Industries—handled 5 channels of wide-band data, putting it into final reduced form simultaneously with the flight's progress.

DAYTON SECTION-IRE has initiated an interesting program. Local IRE members are eligible for awards if they publish technical papers in nationally recognized professional or scientific journals. Awards will range from \$25 to \$200. A Meetings and Papers Committee will judge the papers. Proceedings of conferences papers are not eligible unless subsequently published in a journal of the type mentioned above.

EIA RECOMMENDS that the Renegotiation Act of 1951 be allowed to expire. EIA points out that the law was a temporary wartime measure as a safeguard against excessive or wind-fall profits by defense contractors. These conditions no longer exist, says EIA, since procurement agencies are now sufficiently well staffed and pressures of time sufficiently relieved.

WE HEAR that some Chinese-born American scientists are being offered jobs by the Red Chinese government.

TREASURY DEPARTMENT is expanding its electronic facilities for payment and reconciliation of Government checks, to include the processing of about 275,000,000 postal money orders a year. Action should save the Government about \$650,000 annually.

HOPEFUL TURN in the export picture is seen in the latest figures on the U. K.-to-U. S. shipments. For the first time in more than a decade, the export curve has dipped. During the first half of 1960 the U. K. exported \$9.1 million worth of electronic goods to U. S., compared with \$9.4 million in the same period of 1959. Record players were down 20%; phonograph parts and accessories 58%. Speakers and microphones took an 11% drop and radio receivers, 18%. The dip in consumer goods was partly offset by a 59% increase in the shipments of communications, navigation and radar equipment.

MOST POWERFUL SHOCK TUBE

In this tube, made of Corning's Pyrex glass piping, Boeing scientists are creating shock waves. The waves begin at 300 times the speed of sound and then collide in the tube at a "slowed" rate of 80 times the speed of sound. Tube is used to develop effective ion and plasma-propulsions systems for use in space.

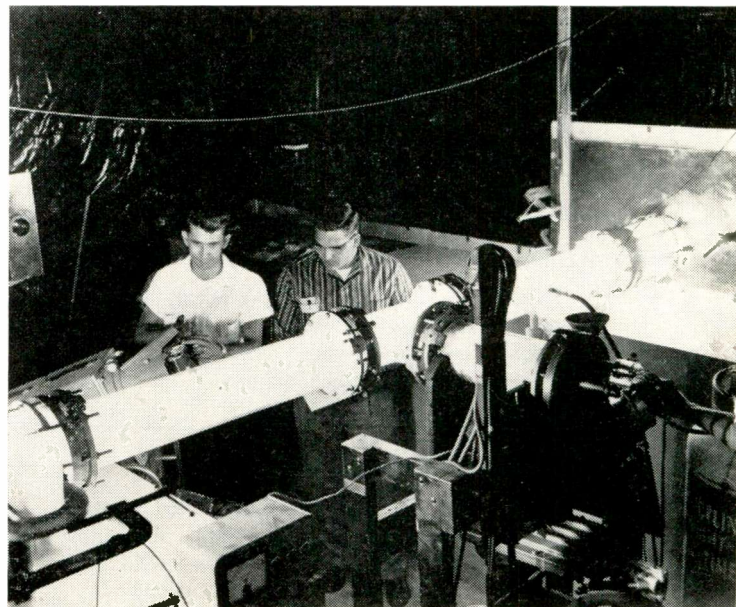

Analyzing current developments and trends throughout the electronic industries that will shape tomorrow's research, manufacturing and operation

COMPUTERS have become so important to scientific investigation that progress in various fields has lagged seriously due to lack of computing facilities. Organizations such as the National Science Foundation are underwriting the costs of computers—at least partially—for research activities in selected fields and in selected parts of the country.

EQUIPMENT LEASING—an old practice in some industries—is increasing in the electronic industries. Companies are becoming reluctant to tie-up their capital in expensive equipment; e.g. computers. Others find that new equipment is being developed so fast that before they can get full use out of their equipment it is obsolete.

BRAWL IS SHAPING-UP between NASA and Air Force. Air Force is pushing for a bigger control of the space programs. Cost of the Air Force's program is tremendous but Kennedy Administration, practically committed by pre-election promises, will probably be sympathetic.

ENGINEER EMPLOYMENT rose 6.6% from January 1959 to January 1960. This compares to 5% rise from 1958 to 1959. More than 800,000 scientists and engineers are now employed by U. S. business firms. The number of additional scientists and engineers that were self employed has not yet been determined.

GRADUATE RESEARCH sorely needs laboratory facilities, but the 150 institutions offering doctorate degrees are not in a financial position to build them. This is a most pressing problem that must be materially improved if an even reasonably satisfactory job of training scientific manpower is to be accomplished in the U. S.

TREASURY DEPARTMENT'S Internal Revenue Service will define "scientific" organizations for tax purposes. Under the new regulation, scientific research will be regarded as carried on in the public interest and be exempt from tax if patents, copyrights, processes, or formulae derived are made available to the public on a nondiscriminatory basis.

MAGNETOGASDYNAMIC ENGINE thrust has been directly measured by Northrop Corp's Norair Division. Propulsive fluid used was ionized nitrogen gas. They injected the gas into a 20-foot vacuum tank at 16,000 ft/sec. The plasma was accelerated by crossed electric and magnetic fields to an equivalent velocity of 40,000 ft/sec. Measurements of the reactive forces show thrust levels on the order of 2 lbs. maintained for as long as 1 min. Thrust was measured with a three degrees-of-freedom thrust balance and strain gages.

FAA STEPS to increase air safety should get increased support after the recent traffic collision over New York City. Fact is FAA has been moving toward automatic control of air traffic for some time. Examples: Computers, installed at six major Air Route Traffic Control Centers were interconnected in 1960 to exchange information about air traffic crossing the boundary of each. The FAA is already preparing for the production of a Mach 3 transport and for its acceptance into airway traffic.

FIGHT LOOMS in Congress over implementing the Landis Report. Report was critical of some aspects of FCC and other regulatory agencies and recommended reorganization by the Executive. Some in Congress feel that these federal commissions are their concern and will probably fight to keep the White House from gaining more control.

EXPECT INTENSIFIED EFFORT to develop lower-cost three-dimensional radar systems for aircraft safety systems. These radars, which determine the identity and altitude of airplanes as well as their distance and direction, are available now but cost—about a billion dollars for a national system—has held up their installation.

COMPUTER-DESIGNED COMPUTER

At Bell Labs, Whippany, N. J., engineer G. A. Sellers checks design information for the first computer built from complete data furnished by another computer. A subassembly of the computer is on the table. The computer will be used with the target track radar for the Army's NIKE-ZEUS antimissile defense system.

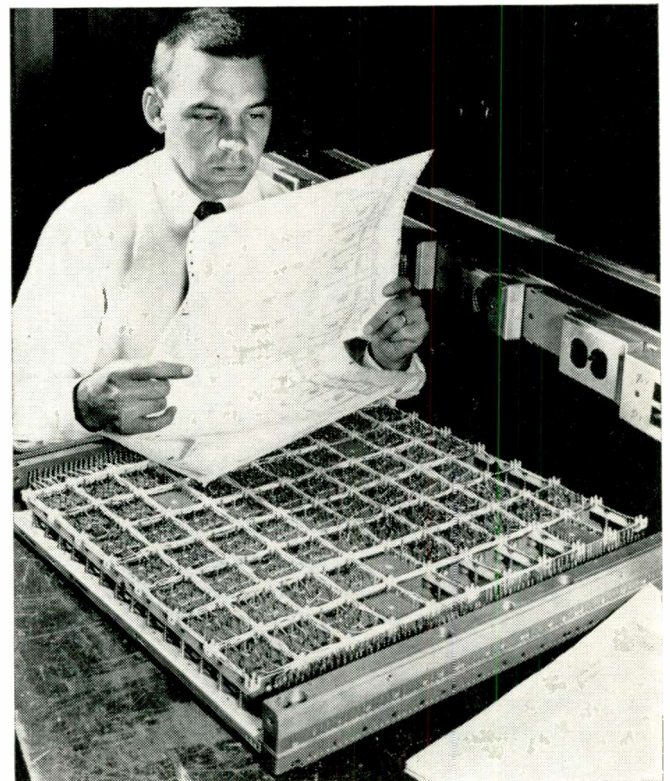

Here is another GIANT STEP toward optimum reliability...

★ Sprague Electric's new COMPULYTIC Capacitors now permit digital computer power supply filtering at operating temperatures to 85 C as standard. This is a full 20 C higher than capacitors offered by other sources. COMPULYTICS will reduce your design headaches and cut down your cooling and ventilating problems.

New!
compulytic*
capacitors
are now
designed for
85 C operation

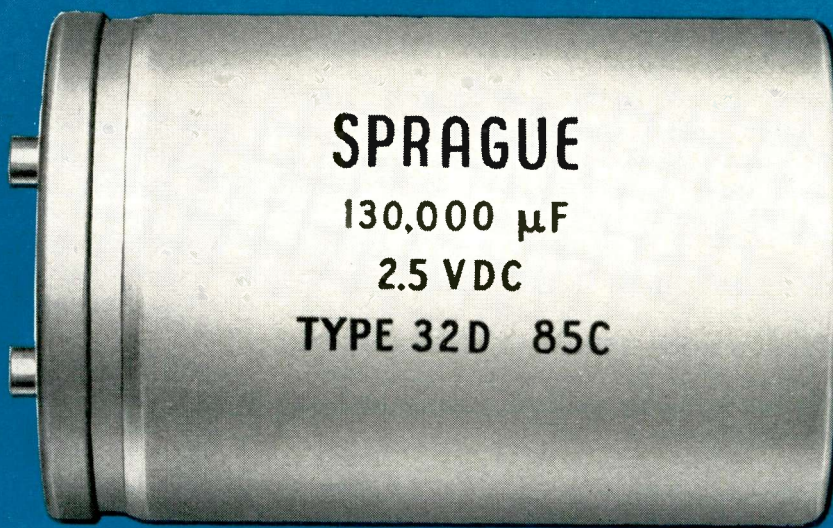

*Trademark

★ Under normal 85 C operating conditions, Type 32D COMPULYTIC Capacitors display extremely low leakage current, low equivalent series resistance, and have higher permissible ripple current values. Extended shelf life of 3 years and more is another outstanding feature.

★ Ratings up to 130,000 μ F at 2.5 volts or 630 μ F at 450 volts are skillfully packed into the largest standard case size of 3" dia. by 4 $\frac{5}{8}$ " high. Capacitor banks as large as 1 farad have been constructed, in relatively small space, using COMPULYTIC Capacitors.

★ Because of their extremely high stability, COMPULYTICS are ideally suited for use in continuously adjustable voltage power supplies since they will not "deform" when operated for long periods at lower than rated voltages.



For complete specifications on Type 32D COMPULYTIC Aluminum Electrolytic Capacitors, write for Engineering Bulletin 3441B to Technical Literature Section, Sprague Electric Co., 233 Marshall St., North Adams, Massachusetts.



SPRAGUE COMPONENTS:

CAPACITORS • RESISTORS • MAGNETIC COMPONENTS • TRANSISTORS • INTERFERENCE FILTERS • PULSE NETWORKS
HIGH TEMPERATURE MAGNET WIRE • CERAMIC-BASE PRINTED NETWORKS • PACKAGED COMPONENT ASSEMBLIES

As We Go To Press . . .

1961 I.R.E. Awards Go To Bown and Guillemin

At the 1961 IRE Convention, March 22, the annual Founders Award will go to Ralph Bown, former Bell Telephone Labs scientist. Dr. Ernest A. Guillemin, Webster Professor of Electrical Engineering at MIT, will get the 1961 Medal of Honor.

Bown's citation is for "outstanding service to the IRE and for outstanding contributions to the radio engineering profession through wise and courageous leadership in the planning and administration of technical developments, which have greatly increased the impact of electronics on the public welfare."

Dr. Guillemin's award, highest of the annual technical awards, is for "outstanding scientific and engineering achievements."

Other winners: Dr. Esaki, consultant at IBM Research Lab., Poughkeepsie, N. Y.—"for important contributions to the theory and technology of solid state devices, particularly as embodied in the tunnel diode"; Helmut L. Brueckmann, U. S. Army Signal Research and Development Laboratories, Fort Monmouth, N. J.—"for outstanding contributions to the theory and technology of antennas"; Manfred Clynes, Rockland State Hospital, Orangeburg, N. Y., for his paper, "Respiratory Control of Heart Rate; Laws Derived from Analog Computer Simulation"; Peter C. Goldmark, CBS Laboratories, Stamford, Conn.—"for important contributions to the development and utilization of electronic television in military reconnaissance and in medical education"; and to Britton Chance, Professor and Director, Johnson Research Foundation, Univ. of Pennsylvania—"for the application of a variety of advanced electronic techniques in a long-term program of fundamental biological research."

Seventy-six leading radio engineers and scientists from the U. S. and other countries have also been named Fellows of the Institute.

On Radar Advisory Group

Harold A. Wheeler, VP and Director of Hazeltine Corp., has been appointed to the Department of Defense Advisory Group on Radar. Membership of this group includes representatives from major laboratories and governmental agencies.

OPTICAL MASER



IBM scientists Dr. Peter P. Sorokin (L) and Dr. Mirek J. Stevenson prepare an experiment with a new trivalent uranium optical maser. The trivalent uranium maser emits coherent light waves which have a sharply defined frequency and propagate an intense, directional beam.

NBS to "Listen" To Earth's Pulses

The National Bureau of Standards, Boulder, Colorado, is building a 6-ft. dia. sensitive antenna which will respond to faint, low-frequency electromagnetic waves or micropulsations which exist on a world-wide basis. The signals are below 20 CPS—principally oscillations of from 5 to 30 sec. periods.

Little is known about the signals except that they are much stronger in the auroral zones and are probably associated with the influx of primary electrons into the ionosphere after solar storms.

The antenna will have over 130 miles of copper wire wound on the rim of the loop in four separate channels. The wire is covered with a layer of copper screening and the whole antenna coated with fiberglass.

H. L. Hoffman Keynotes Reliability Conference

H. Leslie Hoffman, President of Hoffman Electronics Corp., recommended a strengthened national policy on the reliability of electronic equipment and its uniform application among the military services at the 7th Annual Reliability and Quality Control Conf., Phila., Pa.

Some of the dividends, he pointed out, of such a national policy are: substantial savings to the taxpayer, fewer abortive air missions, and swifter advances in electronic equipment performance and reliability. He recommended that the Government assume a greater responsibility, by requiring that the stringent AGREE procedures be followed. The Government should spell out its demands in specific and measureable terms, and share a larger proportion of the manufacturer's costs in reaching these goals. Savings to the taxpayer would result through reduced costs in operation, maintenance, training, spare parts supply and other areas.

Minow Named FCC Head

Newton N. Minow, law partner of Adlai E. Stevenson, has been selected by President John F. Kennedy to head the Federal Communications Commission. Minow, 34, succeeds Frederick W. Ford.

More News
on Page 8

BLUE SCOUT

Air Force's Blue Scout three-stage rocket sheds its payload heat shields, exposing scientific equipment. It measures 8 different types of environmental conditions in space. It was developed by Ford's Aero-nutronic Division.

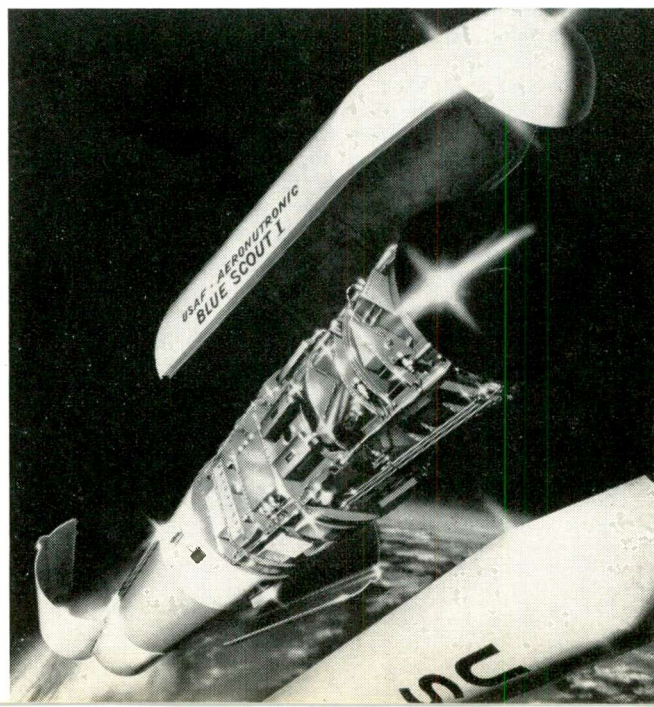

▶ Lockheed's Missile and Space Div. has a contract to design and build a prototype sterilizing unit for the U. S.'s first lunar landing space vehicle. Unit—a mobile sterilization gas transfer system—is for the Ranger-Agena Program of NASA. An international agreement aims to insure against contaminating celestial bodies.

▶ Whirlpool Corp., St. Joseph, Mich. is developing a unit which can provide all foods and beverages for three space pilots on a 14-day mission. The 10 ft. long, 7½ ft. dia. space kitchen will use a thermo-electric refrigerator and freezer. Weightlessness is the big problem. Most food will be in pre-processed or dehydrated form and packaged in disposable containers resembling large toothpaste tubes.

▶ Westinghouse Electric Corp., Air Arm Div. will study requirements for the defensive system for the Air Force's B-70 intercontinental bomber. System is expected to use electromagnetic and other techniques to make it difficult to attack the B-70. It will use electronic countermeasures to "confuse, delay, distort, and even deny enemy intelligence." North American Aviation is prime contractor.

▶ Electronic Associates, Inc., Long Branch, N. J., has a transistorized "do-it-yourself" special purpose analog computer that will perform a variety of laboratory, engineering and process control computing tasks. PACE solid state analog computing components simply plug into a TR-5 mounting unit where they may be interconnected according to the computing function to be performed.

Pilots practicing night landings or takeoffs in ground trainers will be able to see an exact, moving picture of the landing field, runways and lights with a new, closed loop TV device made by Fairchild Astrionics Div., Wyandanch, L. I., N. Y. Wright Air Development Div., Dayton, Ohio sponsored the project. Attachment may be connected to any one of 8 different types of simulators with plug-in devices.

Bendix Corp., under contract to the Signal Corps, will develop the communications system for Project Advent. Project will conduct R & D to demonstrate feasibility of a microwave communications satellite that would operate in a 24-hr synchronous equatorial orbit, receiving and amplifying radio signals and retransmitting them to ground stations.

Aldan Systems Co., Westboro, Mass., has introduced an interplant facsimile system which can transmit instantaneously 30,000 average messages per week—letters, forms, financial statements or drawings on any size paper—more than 300 miles for less than a nickel each. System would use new microwave channels approved by FCC or leased telephone lines.

▶ The Military Products Div., Hoffman Electronics Corp., has received a \$350,000 contract from the U. K. for TACAN Beacon Simulators. The simulators will be used in testing and calibrating airborne TACAN Navigational equipment already delivered by Hoffman.

▶ Kenneth Bullington of Bell Telephone Labs has developed a new explanation of long distance radio communication (TV and higher frequencies). He uses a new mathematical approach to the concept that long range transmission is a logical consequence of the average decrease in the index of refraction of the atmosphere with height above the earth. Results indicate that earlier approximations discarded the most important effect. The simple concept offers a good quantitative explanation and ties together more diverse experimental data than had been attempted in previous theories.

▶ The FAA is adding nine additional long range radars to its air traffic control system for handling heavy en route air traffic. Raytheon Co., Waltham, Mass., has the \$5.2 million contract. Range of the new radars on transport type aircraft will be 200 mi. At a shorter range, the radars will be able to track aircraft to 60,000 ft. Study and design contract for speech-bandwidth-compression has been awarded—by the Rome ADC—to Electro-Mechanical Research, Inc., Sarasota, Fla. EMR will study time-multiplex methods of transmitting three voice channels in the bandwidth normally required for one.

PHONE RELAY SATELLITE

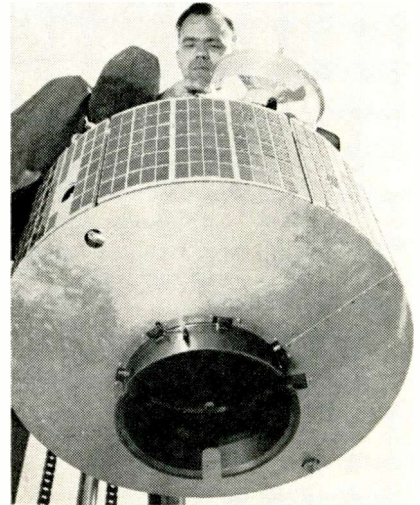

Communications satellite developed by Hughes Aircraft Co. can handle hundreds of telephone circuits and direct TV transmission if placed in equatorial orbit at 22,000 mi. altitude. James C. Meyer, environmental engineer, inspects the device's 2,700 power providing, solar cells.

Ultraviolet Protection

Westinghouse Electric Corp., Lamp Div., Bloomfield, N. J., is offering professional services to hospitals interested in installing ultraviolet protection in their operating rooms. The system drastically reduces post-operative infection.

New Solar Telescope

The world's largest solar telescope is now being built near Tucson, Ariz., at the Kitt Peak National Observatory. It will allow geophysicists to conduct spectrographic analyses of the sun's surface. Eruptions of fast moving gases, radiation, electromagnetic forces and other phenomena will also be studied with the instrument.

Three large mirrors will be used to focus the sun's rays into a bright image, 34 in. in dia. The largest mirror, part of an assembly called a heliostat, will have a dia. of 80 in. It will be rotated on its axes by light-sensitive servo devices so that the sun's light will be transmitted through a 480-ft tunnel to a second mirror and then to a third. The second mirror is parabolic, 60 in. in dia.; the third is flat, with a dia. of 48 in.

Westinghouse Electric Corp., Sunnyvale, Calif., is building the heliostat mounts. The Association of Universities for Research in Astronomy is designing and will operate the observatory.

BASIC



because...



It Measures

VOLTAGES

from 0.5 mv to 10v, dc

CURRENTS

from 0.005 μ ma to 1 ma, dc

RESISTANCES

from 0.3 M Ω to 500 MM Ω

... it can also be used as a d-c amplifier with a current gain of over 16×10^9 ... use it as a "front end" to drive recorders and other instruments

- ✓ True direct-coupled amplifier design — no choppers, vibrators, or reeds to give mechanical trouble or get out of adjustment.
- ✓ High input resistance: 100 mega-meg-ohms — does not load down sensitive circuits. Input resistance can also be set by switch to other values from 10^4 to 10^{11} ohms.
- ✓ Constant low voltage across unknown (9.1v) — no need for voltage coefficient corrections when making high resistance measurements.
- ✓ Output for 5-ma recorders.

**Type 1230-A D-C Amplifier
and Electrometer... \$440**

Write For Complete Information

GENERAL RADIO COMPANY

WEST CONCORD, MASSACHUSETTS

The Best Instruments
In Electronics

NEW YORK, WOrth 4-2722
NEW JERSEY, Edgelfeld, WHitney 3-3140

CHICAGO
Oak Park
Village 8-9400

PHILADELPHIA
Abington
HANcock 4-7419

WASHINGTON, D.C.
Silver Spring
JUUniper 5-1088

SAN FRANCISCO
Los Altos
WHIteliff 8-8233

LOS ANGELES
Los Angeles
HOLLYwood 9-6201

IN CANADA
Toronto
CHerry 6-2171

Circle 3 on Inquiry Card

Coming Events in the electronic industry

- Jan. 29-Feb. 3: Winter General Meeting, AIEE; Statler-Hilton & Governor Clinton Hotels, New York, N. Y.
- Jan. 30-Feb. 3: Committee Week, ASTM; Netherlands Hilton Hotel, Cincinnati, Ohio.
- Jan. 31-Feb. 2: Cleveland Electronics Conf., Cleveland Eng'g Soc., IRE, AIEE, ISA, Cleveland Physics Soc., Case Inst. of Tech., Western Reserve Univ.; Cleveland Eng'g & Scientific Center, Cleveland, Ohio.
- Feb. 1-2: 7th Annual Midwest Welding Conf., Ill. Inst. of Tech.; Technology Center, Chicago, Ill.
- Feb. 1-3: Solid Propellant Rocket Conf., ARS; Hotel Utah, Salt Lake City, Utah.
- Feb. 1-3: 1961 Winter MIL-E-CON Military Electronics Conv., IRE, PGME (Los Angeles Section); Biltmore Hotel, Los Angeles, Calif.
- Feb. 1-4: Annual Meeting, American Inst. of Physics; Hotel New Yorker, New York, N. Y.
- Feb. 1-4: Meeting, American Physical Soc.; New York, N. Y.
- Feb. 1-4: 2nd Annual Conv., ERA; Ambassador Hotel, Los Angeles, Calif.
- Feb. 9-11: Winter Meeting, Nat'l Soc. of Professional Engrs.; Ft. Des Moines Hotel, Des Moines, Iowa.
- Feb. 13-15: 6th Western Industrial Writing Inst. for Eng'g, Sales and Administrative Management, American Industrial Writing Inst.; Hotel Statler-Hilton, Los Angeles, Calif.
- Feb. 13-16: 15th Int'l Heating & Air-Conditioning Exposition, American Soc. of Heating, Refrigerating & Air-Conditioning Engrs.; International Amphitheatre, Chicago, Ill.
- Feb. 14-16: 2nd Annual Symposium on Nondestructive Testing of Aircraft and Missile Components, Soc. for Nondestructive Testing, Southwest Research Institute; Gunter Hotel, San Antonio, Texas.
- Feb. 15-17: Int'l Solid State Circuits Conf., IRE, AIEE, Univ. of Penna.; Univ. of Penna. & Sheraton Hotel, Phila., Pa.
- Feb. 16: Mechanical Impedance Testing Mtg., IES (N.Y. Metro. Chpt.); Busto's Restaurant, New York, N. Y.
- Feb. 17-21: 4th Int'l Exhib. of Electronic Components; Parc des Expositions, Porte de Versailles, France.

"CALL FOR PAPERS"

- 17th Annual Society of Plastics Engineers, Inc., Tech. Meeting, Jan. 24-27, Shoreham Hotel, Wash., D. C. Deadline date for papers: Aug. 1, 1961.
- Radio Tech. Commission for Marine Services Meeting, Apr. 5-7, Sheraton Palace Hotel, San Francisco, Calif. Deadline date for papers: Mar. 15, 1961. Forward to: G. R. McLeod, Exec. Sec'y, RTCM, c/o FCC, Wash. 25, D. C.
- 9th National Conf. on Electromagnetic Relays, Apr. 25-27, Oklahoma State Univ., Student Union Bldg., Stillwater, Okla. Deadline for all papers: Mar. 1, 1961. Forward to: Prof. Charles F. Cameron, School of Electrical Engineering.
- Meeting, Acoustical Society of America, May 11-13, 1961. Deadline date for Abstracts: 10 weeks before meeting date. Contact: Chairman, Mones Hawley, RCA, Morrestown, N. J.
- Meeting, Armed Forces Communications & Electronics Assoc., June 6-8, 1961. Sheraton - Park Hotel, Wash., D. C. Deadline for papers: Mar. 2, 1961.
- Spring Conf. for 1961, Chicago Prof. Group on Broadcast and TV receivers of the IRE, June 15-16, O'Hare Inn, Des Plaines, Ill. Deadline for papers: Submit 3 copies of following by Feb. 15, 1961—50 to 100 word summaries including title of paper, author's name, position, title, company affiliation. Forward to: Neil Frihart, Motorola, Inc., 4545 W. Augusta Blvd., Chicago 51, Ill. Limit papers to 2500 words (20 min. presentation).
- 1961 International Conf., The 4th International Conf. on Medical Electronics combined with The 14th Annual Conf. on Electrical Techniques in Medicine and Biology, July 16-21, 1961, The Waldorf-Astoria, N. Y., N. Y. The Joint Executive Committee on Medicine and Biology (IRE-AIEE-ISA) submit Abstracts of 300 words for preliminary review and 50-word Summary for inclusion in an Advance Program before Apr. 1, 1961. Six-hundred to 1000-word Digests to appear in Conference Digest must be received by Program Committee before May.

- Feb. 20-22: Meeting, American Physical Soc.; Monterey, Calif.
- Feb. 20-22: Winter Meeting, Plumbing Brass Inst.; Riviera Hotel, Palm Springs, Calif.
- Feb. 20-25: Int'l Symp. on Semiconductor Devices, French Radio-Engr's Assoc., French Nat'l Electronic Industries Assoc.; Paris, France.
- Feb. 21: EP & EM Educational Seminar, Assoc. of Electronic Parts & Equip. Mfrs.; Niles, Ill.
- Feb. 21-30: 139th Mtg., American Chemical Soc., St. Louis, Montana.
- Feb. 22: Mtg., American Mathematical Soc.; Yeshiva Univ., New York, N. Y.
- Feb. 22: Reliability Symp., ASQC and Eng'g Div. (Los Angeles Sect.), Univ. of Calif., Los Angeles; Statler Hotel, Los Angeles, Calif.
- Feb. 22-24: Pacific Coast Show, Material Handling Inst.; Cow Palace, San Francisco, Calif.
- Feb. 23: Joint Tech. Mtg., ASQC, PGRQC (N.Y. Metropolitan Chpt.); Hotel Martinique, New York, N. Y.
- Feb. 25: Annual Dinner Cruise, Veteran Wireless Operator's Assoc., Inc.; Edison Hotel, New York, N. Y.
- Feb. 26-Mar. 2: AIME Annual Mtg. (Metallurgical Soc.), AIME; Ambassador and Chase - Park - Plaza Hotels, St. Louis, Mo.
- Feb. 26-Mar. 2: Annual Mtg., Amer. Inst. of Mining, Metallurgical & Petroleum Engrs.; New Orleans, La.
- Feb. 26-Mar. 1: 1st Annual Pacific Electronic Trade Show (PETS), Western Distributor Segment of the Industry; Great Western Exhibit Ctr., Los Angeles, Calif.
- Feb. 27-Mar. 3: Pittsburgh Conf. on Analytical Chemistry & Applied Spectroscopy; Penn-Sheraton Hotel, Pittsburgh, Pa.

(Continued on page 12)

ABBREVIATIONS

- AIEE: American Institute of Electrical Engineers
 AIME: American Institute of Mining, Metallurgical & Petroleum Engineers
 ARS: American Rocket Society
 ASQC: American Society for Quality Control
 ASTM: American Society for Testing Materials
 EP & EM: Association of Electronic Parts & Equipment Manufacturers
 ERA: Electronic Representatives Association
 IES: Institute of Environmental Sciences
 IRE: Institute of Radio Engineers
 ISA: Instrument Society of America
 PETS: Pacific Electronic Trade Show
 PGME: Professional Group on Medical Electronics
 PGRQC: Professional Group on Reliability and Quality Control
 WEMA: Western Electronic Manufacturer's Association

SOMETHING NEW IN A SUITCASE

... Complete transistorized EECO Digital System Breadboard

Designers who want to go places fast systemswise can be sure of getting there on time with an EECO suitcase. It's packed with a complete and integrated breadboarding system designed around mutually compatible EECO T-Series Germanium circuit modules, N-Series transistorized decades, and R-Series Minisig® sensitive indicators.

Standard 19" amateur-notched panels have the necessary permanent wiring to accommodate any standard EECO Germanium circuit module, and all other circuit interconnections are made by patch cords or plugs, with unique, prepunched circuit cards to guide you. No soldering is required, and experimental arrangements of T-Series circuits can be quickly patched up, changed, or taken down without waste of time or materials.

CIRCUIT CARDS

A unique feature of the EECO T-Series breadboarding system is the use of plastic circuit cards, which are imprinted with circuit symbols, showing input and output connections, power connections, part number, application notes, etc. These cards fit on the panel below sockets for the plug-in units, and expose the proper pattern of banana jacks that are permanently wired to pins on the sockets.

EECO T-Series breadboard equipment is available in both suitcase and rack-mounted types. Breadboard Kits of any degree of complexity can be built up in stages, according to the specific panels and number of circuits incorporated. Compatible interconnections between racks or suitcases further enable the designer to expand the equipment into a complete systems development console. Compatible solid-state, convection-cooled power supplies are also available in two different models: ZA-720 is a dual 12-volt, 5-amp supply; ZA-721 is a 12-volt, 1-amp plug-in power supply.

Analysis of the operation of a digital system can be made with a minimum of test instrumentation.

EECO T-Series Breadboard Suitcase is a standard "3-suitcase" that can be locked and stored when not in use, to prevent jampering and "circuit snatching."

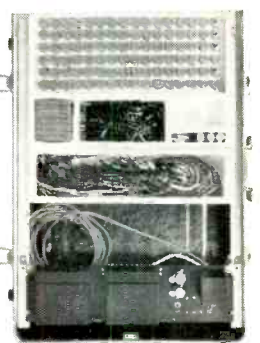

Bottom half of breadboard suitcase is compactly laid out to store all necessary T-Series circuit modules, circuit cards, patch cords, and compatible power supplies.

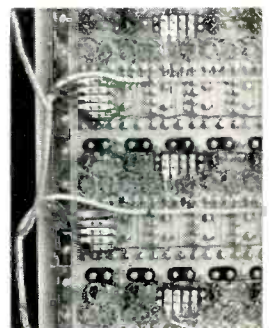

Panels are mounted on piano hinge to permit easy access to permanent wiring and power cabling.

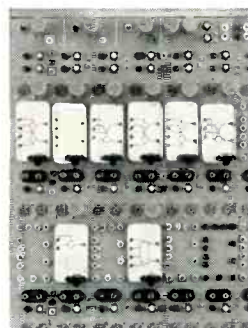
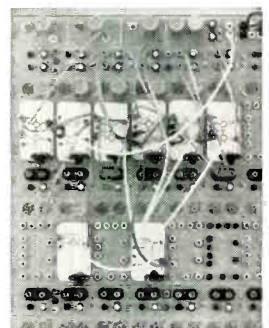

Circuit cards are selected according to the system it is desired to breadboard and placed on the panel in alignment with the jack pattern. Corresponding T-Series circuit modules are plugged in above each card.

Circuit interconnections are made by patching through holes in the circuit cards. Resulting pattern of symbols and patch cords shows a schematic and bill of materials for the system, once it is checked out.

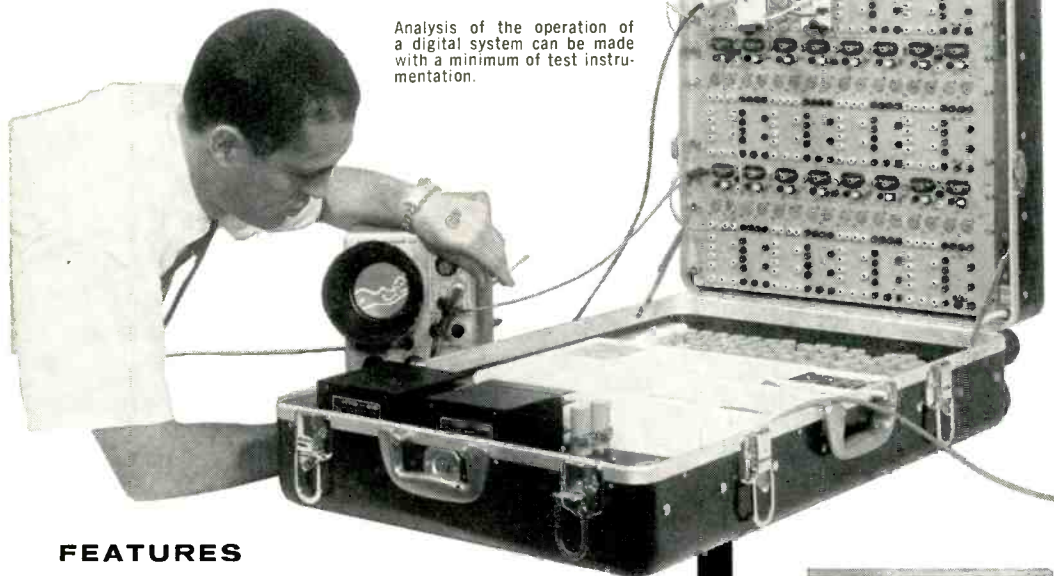

FEATURES

- Permits rapid formulation of digital electrical systems.
- System may be operated slowly to permit inspection of its mode of operation, or over-speed to indicate system derating.
- Operation may be analyzed with a minimum of test equipment.
- Provides a means for rapidly building and testing alternate ways of formulating a system.
- Minimizes wiring errors and the inclusion of defective parts.
- Circuit cards provide a means for rapidly visualizing the system, and facilitate drawing a circuit diagram.
- Circuit cards enable the designer to determine the elements involved, as well as the cost of the system.

A request, on your company letterhead, will bring detailed information on the flexibility of the EECO T-Series Breadboarding equipment, and a demonstration if desired.

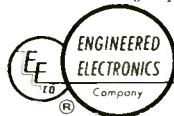

ENGINEERED ELECTRONICS COMPANY

1441 East Chestnut Avenue • Santa Ana, California

Coming Events

(Continued from page 10)

HIGHLIGHTS OF 1961

- Feb. 15-17: Int'l Solid State Circuits Conf., IRE, AIEE, Univ. of Penna.; Univ. of Penna. & Sheraton Hotel, Phila., Pa.
- Mar. 20-23: IRE Int'l Conv., IRE; Coliseum & Waldorf Astoria Hotel, New York, N. Y.
- Apr. 17-19: Annual General Session of JEDEC; Hotel Syracuse, Syracuse, N. Y.
- Apr. 19-21: SWIRECO — S.W. IRE Regional Conf. & Elec. Show, IRE (Region 6); Dallas, Tex.
- May 8-10: NAECON (Nat'l Aeronautical Electronics Conf., IRE (PGANE) (Dayton Sec.); Miami & Dayton Biltmore Hotels, Dayton, Ohio.
- May 9-11: Western Joint Computer Conf., IRE (PGEC), AIEE, ACM; Ambassador Hotel, Los Angeles, Calif.
- May 22-24: 5th Nat'l Symp. on Global Communications (GLOBECOM V), IRE (PGCS), AIEE; Sherman Hotel, Chicago, Ill.
- May 22-24: Nat'l Telemetry Conf., IAS, IRE, AIEE, ARS, ISA; Sheraton-Towers Hotel, Chicago, Ill.
- June 28-30: Joint Automatic Control Conf., IRE, AIEE, ASME, ISA, AICHe; Univ. of Colorado, Boulder, Colo.
- Aug. 22-25: WESCON: Western Electronic Show & Convention, WEMA, IRE (L.A. & S.F. Sect.); Cow Palace, San Francisco, Calif.
- Oct. 9-11: Nat'l Electronics Conf. (NEC), IRE, AIEE, EIA, SMPTE; Amphitheatre, Sherman Hotel, Chicago, Ill.
- Oct. 30-Nov. 1: Radio Fall Meeting, EIA, IRE; Hotel Syracuse, Syracuse, N. Y.
- Nov. 14-16: MAECON (Mid-America Elec. Conf., IRE (Kansas City Sect.); Kansas City, Mo.
- Nov. 14-16: N. E. Res. & Eng. Mtg. (NEREM), IRE (Region 1); Boston, Mass.
- Dec. 3-7: Eastern Joint Computer Conf., IRE (PGEC), AIEE, ACM; Sheraton-Park Hotel, Washington, D. C.

New NEC Officers

Joseph J. Gershon, DeVry Technical Institute, has been elected President of the National Electronic Conference for 1961.

Other officers are: Vice President—James H. Kogen, GPE Controls, Inc.; Secretary—Dr. Thomas F. Jones, Jr., Purdue Univ.; Treasurer—Robert J. Parent, Univ. of Wisconsin; Assistant Treasurer—Dr. James S. Aagaard, Northwestern Univ.

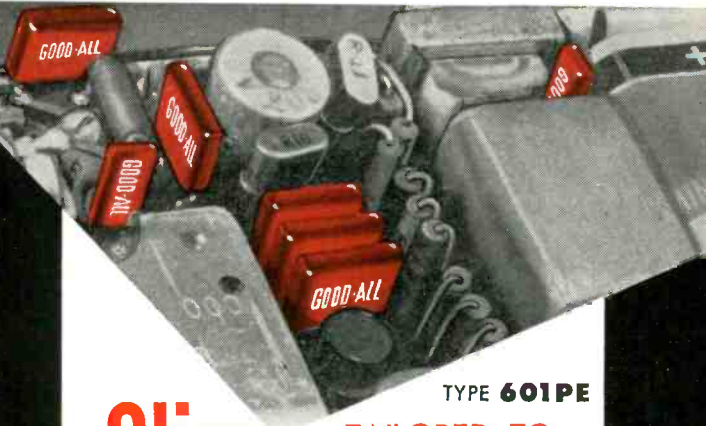

Slim... TAILORED TO TRANSISTORS

TYPE 601PE

GOOD-ALL 601PE CAPACITORS are wafer thin to "fit like a disc". Capacitance is highly stable with temp. Equal in all respects to high quality Good-All tubulars. Available in 50 volt ratings only, they are competitive in price with ceramic discs in the range of .1 mfd and above. The case is moisture resisting Epoxy. Type 601PE is capable of being produced to HI-REL. specifications on a "special project basis".

SPECIFICATIONS

Insulation Resistance—Greater than 75,000 megohms when measured at 100 volts D.C. at 25° C. for a maximum of 2 minutes.

Capacity Tolerance—Standard tolerance $\pm 20\% \pm 10\% \pm 5\%$

Winding Construction—Extended foil (non-inductive) MYLAR Dielectric.

Lead Variations—Formed or straight leads.

Dissipation Factor—Less than 1% at 1,000 cycles per second at 25° C.

Dielectric Strength—100 volts D.C. for 1 to 5 seconds through a minimum current limiting resistance of 100 ohms per volt.

Temperature Range—May be operated at full rated voltage to 85° C. Derate to 50% when operating at 125° C.



DIMENSIONS 50 VDC Rating

CAP. (MFD)	A	E	F
.01	.310	.187	.562
.022	.359	.187	.562
.033	.531	.191	.406
.047	.531	.203	.453
.068	.531	.218	.500
.1	.650	.235	.525
.15	.671	.260	.650
.22	.728	.306	.687
.33	.812	.312	.750

Capacitance Change vs. Temperature

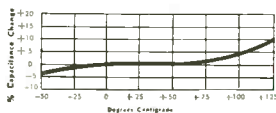

Insulation Resistance vs. Temperature

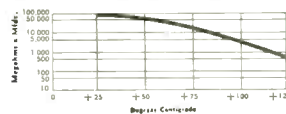

Write for detailed literature



GOOD-ALL ELECTRIC MFG. CO. Ogallala, Nebr.

A SUBSIDIARY OF THOMPSON RAMO WOOLDRIDGE INC.

AVAILABLE AT AUTHORIZED DISTRIBUTORS

CHANGE NOTICE

SUBJECT: *Test Instruments**

DATE OF EFFECTIVITY: *At Once*

WAS



IS



*Hathaway Denver, recognized for quality in design, development and manufacture of measuring, testing and control instruments, announces the acquisition of the test instrument line formerly produced by Dresser Electronics, SIE Division (formerly Southwestern Industrial Electronics Company).

MEMO TO: *Test Instrument Buyers*

The line of test instruments formerly produced by SIE will now be manufactured and distributed by Hathaway Denver and will carry the Hathaway Denver label. The line includes:

VOLTMETER (Model R-2)

This completely new voltmeter offers more in a single instrument, in terms of functional versatility, range and accuracy, than has ever been available in an electronic voltmeter.

- 1 MV-1000 V AC and DC
- 10 ohms -10 megohms midscale
- Frequency range 10 cps -1 mc
- DC Distend—upper 10% or 1% of any DC volts range can be expanded to cover the full meter scale.

MICROSOURCE (Model K-1)

Can be used in conjunction with any standard oscillator in the frequency range of 10 cps-1 mc to produce small, known, controlled test signals. An internal battery and associated polarity reversing switch allow testing of high gain DC amplifiers. Direct reading voltmeter; 10 volts maximum output; continuously adjustable.

SIGNAL GENERATOR (Model N-2)

Continuously variable over the frequency range from 1 cps to 1 mc in 6 overlapping bands, each having a ratio of over 10:1, this signal generator operates from 115 volt line and produces an output of 0 to 10 volts rms at less than 1% distortion.

- Resistance Meters
- Audio Response Plotters
- Vibration Meters
- Comparison Bridges



Write for bulletins on these products

HATHAWAY DENVER

5806 East Jewell Ave., Denver 22, Colo.

A division of HATHAWAY INSTRUMENTS, INC.

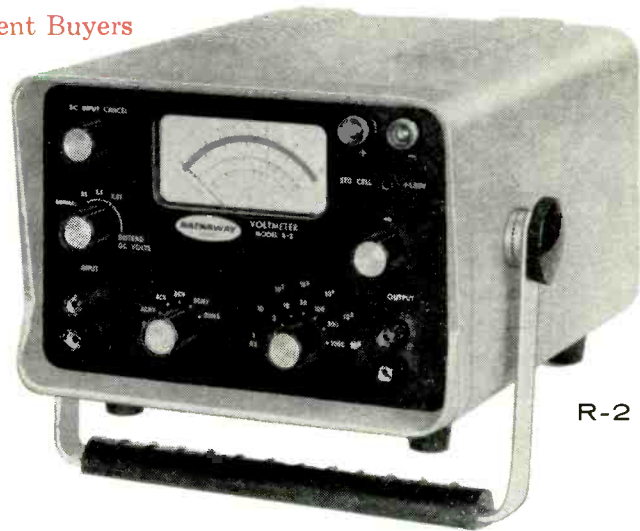

R-2



K-1



N-2

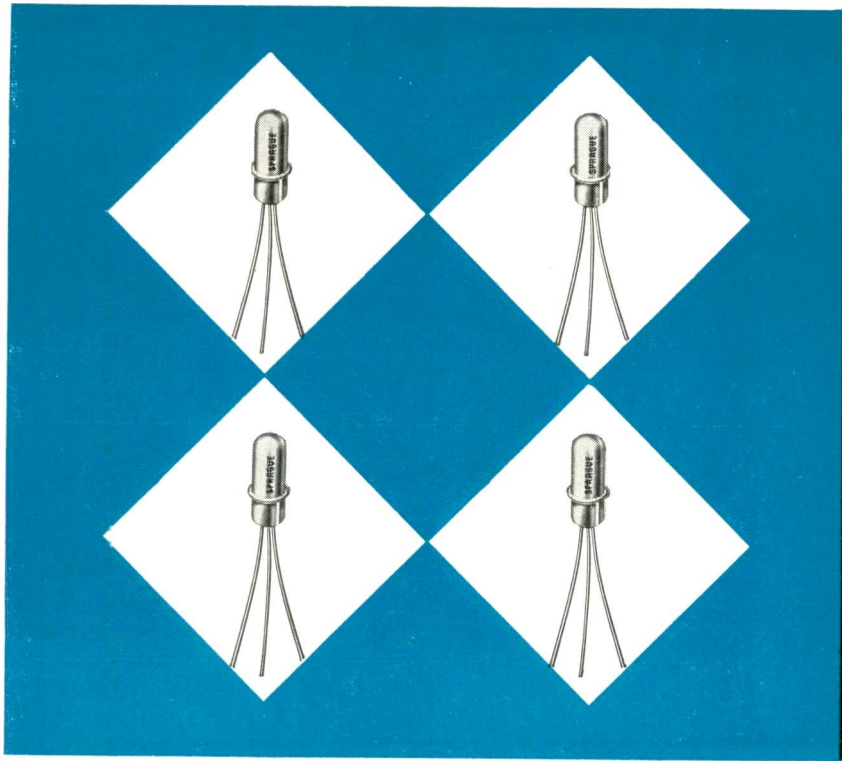

AVAILABLE NOW IN MASS PRODUCTION

- the highest r-f operating frequency
- the fastest switching time
- cadmium junctions for cooler operation, greater reliability
- storage temperatures up to 100°C

YOU CAN GET SPRAGUE* MADT® TRANSISTORS AT SENSIBLE PRICES

Sprague Germanium Micro-Alloy Diffused-Base Transistors, well-known for their rugged vhf performance, are now *priced below other transistors* with comparable electrical characteristics. In many areas, this permits designers to improve circuit techniques without necessarily increasing costs. Expanded production facilities enable us to *ship quantity orders on short notice*. Add to this their *ultra-fast switching time*, and you have three good reasons why Sprague MADT® Transistors have achieved their high level of acceptance.

With Sprague Transistors, circuits in vhf amplifiers and oscillators can now operate with collector currents as high as 50 ma . . . with power dissipation up to 50 mw . . . with collector to base voltages to 15 v. They have been application tested through the entire military electronics vhf spectrum.

The application table may well suggest the use of one or more Micro-Alloy Diffused-Base Transistor types in your latest circuit designs.

For complete engineering data on the types in which

• • •

**Sprague micro-alloy, micro-alloy diffused-base, and surface barrier transistors are fully licensed under Philco patents. All Sprague and Philco transistors having the same type numbers are manufactured to the same specifications and are fully interchangeable.*

MICRO-ALLOY DIFFUSED-BASE TRANSISTOR APPLICATIONS	
Type	Application
2N499	Amplifier, to 100 mcs
2N501	Ultra High Speed Switch (Storage Temperature, 85 C)
2N501A	Ultra High Speed Switch (Storage Temperature, 100 C)
2N504	High Gain IF Amplifier
2N588	Oscillator, Amplifier, to 50 mcs

you are interested, write Technical Literature Section, Sprague Electric Co., 233 Marshall St., North Adams, Massachusetts.

You can get off-the-shelf delivery at factory prices on pilot quantities up to 999 pieces from your local Sprague Industrial Distributor.



SPRAGUE COMPONENTS:

CAPACITORS • RESISTORS • MAGNETIC COMPONENTS • TRANSISTORS • INTERFERENCE FILTERS • PULSE NETWORKS
HIGH TEMPERATURE MAGNET WIRE • CERAMIC-BASE PRINTED NETWORKS • PACKAGED COMPONENT ASSEMBLIES

As We Go To Press...

Navy To Build New Communications Ship

The Navy will design and develop equipment for a shipboard satellite communications terminal which can communicate with two Army shore stations through the ADVENT satellite. Project ADVENT aims at developing a military capability for high capacity, secure, world-wide instantaneous radio communications using high altitude hovering satellites.

ADVENT differs from both ECHO and COURIER. ECHO is a passive device—signals are deflected from an orbiting balloon. COURIER messages are received and stored on tape for later re-broadcasting. ADVENT, since it hovers (at 22,000 ft in a 24-hr orbit) will stay in a direct line of sight of all points on earth enclosed in a circle of 11,300 mile diameter centered just beneath the satellite.

Some of the Navy's problems: The design of an antenna system capable of both transmitting and receiving at microwave frequencies while maintaining the pointing accuracy required in spite of the ship's motion. Although shore antennas may be as large as necessary to provide sufficient gain, shipboard antennas are limited as to size and weight by ship support considerations. Also, the roll, pitch, and yaw of the ship platform must be compensated for by a delicate gyroscopically stabilized alignment system in order to keep the antenna pointed accurately at all times.

New Underseas Cable

AT&T is planning a large-capacity undersea telephone cable between the U.S. and Jamaica, B.W.I. The cable will be completed by late 1962.

The system is designed to handle up to 128 voice circuits—more than three times the capacity of the first trans-oceanic telephone cable laid four years ago.

Newly developed "armorless" cable will be used in the deep-sea section. It has a plastic outer coating, instead of armor wires, and a stranded steel core for tensile strength. Rigid-type "repeaters" (developed by Bell Labs) will be spaced about 20-mi. apart in the cable.

NEW USAF COMPUTER



New IBM 7070 Computer will be used by the A.F. to determine whether centralized computer systems can be operated economically at base level throughout the Air Force. Lt. Gen. J. W. Kelly, MATS Commander, sits at keyboard. Brig. Gen. F. S. Henley (L) and Lt. Col. C. E. Crawford display chart showing operation.

Oak Ridge Will Build New Research Reactor

The Oak Ridge National Laboratory is scheduling construction of a small research reactor. It will provide short bursts of radiation for biomedical and health physics research. It will also be available for programs involving solid state physics, nuclear chemistry, and neutron physics research.

The control building will be about 800 ft. away from the reactor, and behind a ridge which will provide shielding. The control building will have lab space and service areas for research groups.

Ground Trainer Sees Landing Strip with TV

Air Force pilots practicing night landings or takeoffs in ground trainers will be able to see an exact, moving picture of the landing field, runways, and lights with a new, closed loop TV device being built by Fairchild Astrionics Div., L. I., N. Y., for Wright Air Development Div., Dayton, Ohio.

The image, seen by the pilot on a 27-in. monitor, is a precisely scaled and lighted reproduction of the air field. The field appears as it would in flight reflecting the aircraft's pitch, roll, speed, course, etc.

The device is coordinated with the trainer's altimeter and other instruments, so that when the pilot switches from instrument flying to visual approach, he will see the field exactly as his instruments indicated.

Bell Lab's Baker Joins Rockefeller Institute

Dr. William O. Baker, VP-Research, Bell Telephone Laboratories, has been elected to the Board of Trustees of the Rockefeller Institute. The Institute is a graduate university and a center for fundamental research in the life sciences. Dr. Baker has recently been studying the movement of electrons in and through organic substances.

Simulator for NASARR

A new simulator has been developed which matches identically the action of NASARR (North American Search and Ranging Radar).

The simulator will produce displays on a scope for ground mapping, contour mapping, and terrain avoidance. It may be used with an operational flight simulator or as a self-contained radar

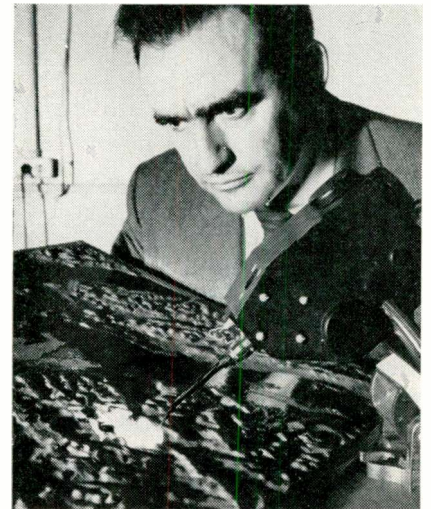

Light source reproduces—radar radiation pattern. Tip represents the aircraft position. Light pattern is analogous to the radiation pattern of the aircraft antenna.

mission trainer for radar navigation and blind-bombing operations.

The simulator, built by ACF Industries, Inc., Riverdale, Md., employs a scan-programmed TV camera and a low-power light source in conjunction with a 3-dimensional terrain map to simulate radar return from land-mass formations, cultural areas, and target complexes exactly like the NASARR itself. Terrain models can be built for any geographic area.

More News on Page 23



RF PRODUCTS

PRODUCES MORE AND DELIVERS FASTER FAMOUS AMPHENOL COAXIAL CABLE AND WIRE

As a new decentralized division of Amphenol-Borg Electronics Corporation, R F PRODUCTS now has responsibility for the engineering, manufacture and marketing of Amphenol Coaxial Cable and Wire. To the electronics industry—and to you—this means more and faster deliveries from factory inventory of the world's largest selection of approved, high quality RG type cable.

R F PRODUCTS also means the consolidation of three great names in radio-frequency components—Amphenol Coaxial Connectors and Cable, IPC Coaxial Connectors, and DK Coaxial Switches. The integration of these related component lines makes possible the engineering-in-depth needed to stay abreast of your demands in this exacting field.

Whether you require sub-miniature coaxial cable, high-temperature flexible cable, large special-purpose multi-conductor cable—or any of hundreds of other varieties—you'll find that R F PRODUCTS offers a comprehensive, single-source supply.

IRE Show: Booth 2501-03

A DIVISION OF AMPHENOL-BORG ELECTRONICS CORPORATION



R F PRODUCTS

DANBURY, CONNECTICUT • Pioneer 3-9272



ELECTRON TUBE NEWS

...from SYLVANIA

New CRT developments stimulate I&M designs!

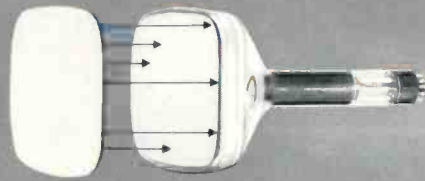

...tubes that eliminate "mirror-images"!



...tubes with built-in reference display scales!

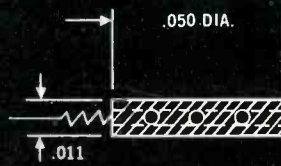

...heaters that consume 94% less power!

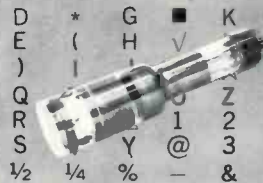

...tubes with built-in character patterns for high-speed printing!

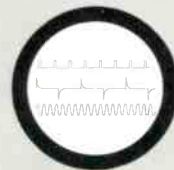

...new multi-trace type CRT!

SYLVANIA "BONDED SHIELD" CRT's FOR I&M DESIGNS—Now Sylvania adds the advantages of "Bonded Shield" to 19 industrial-military cathode ray tubes. A scratch-resistant, annealed-glass safety cap, Sylvania "Bonded Shield" eliminates conventional safety glass . . . cuts reflecting surfaces 50% . . . dramatically reduces specular images . . . increases apparent light transmission and contrast for improved image readability. Image display is brought "out front" for wide-angle viewing, mounting and styling are simplified, tube face is easily cleaned and vastly strengthened against breakage. Sylvania "Bonded Shield" caps are also available with anti-reflection treatment that can diffuse up to 70% of reflected light. Want more? Several CRT types feature calibrated reference scales permanently etched on the bonded safety cap, thereby reducing viewing

errors caused by parallax. Virtually all popular CRT's, from 3" to 27," can be supplied with Sylvania "Bonded Shield." Investigate its potential with your Sylvania Sales Engineer.

Equivalent Standard Type	"Bonded Shield" Type	Equivalent Standard Type	"Bonded Shield" Type
5FP4A	ST-3082	10SP4	ST-3080
5QP4	ST-3077	12KP4A	ST-3081
5UP1	SC-3074	12LP4A	ST-3115
5UP1	SC-3076*	14BAP4	ST-3101
5ABP1	SC-3119*	16WP4B	ST-2843
5ADP1	SC-3114	17BP4A	ST-3084
7SP4	ST-3078	17HP4B	ST-3086
7TP4	ST-3079	17DWF4	ST-3102
8KP4	ST-3100	24YP4A	ST-3085
10FP4A	ST-3083		

*Denotes Standard Modulation Scale printed on face

3 high-resolution CRT's for photo-recording applications

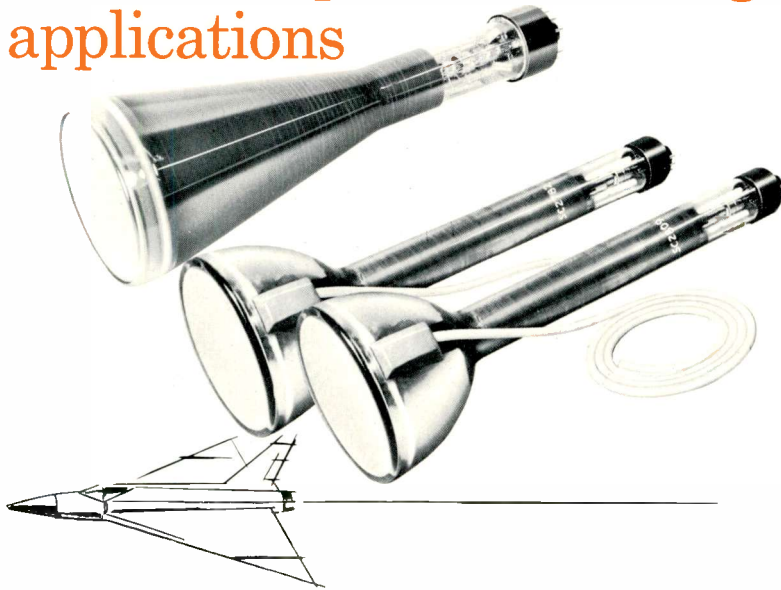

The broad capabilities of Sylvania in the field of high-resolution CRT's are well illustrated by the definition-range of three 5" diameter types. SC-3042 has a line width of 0.0075", SC-2782 offers a 0.001" line width, while the ultra-high-resolution SC-2809 provides a line width of 0.0008"

SYLVANIA SC-3042 features electrostatic focus and deflection, minimum pattern distortion and maximum sensitivity. It is available with a choice of eleven screen phosphors ranging from P1 to P25.

SYLVANIA SC-2782, SC-2809 feature aluminized screens, fine grain P11 phosphor, conventional magnetic focus and deflection, non-ion trap guns. They simplify associated circuitry requirements, offer significant savings in equipment costs. Screen phosphors other than P11 are also available.

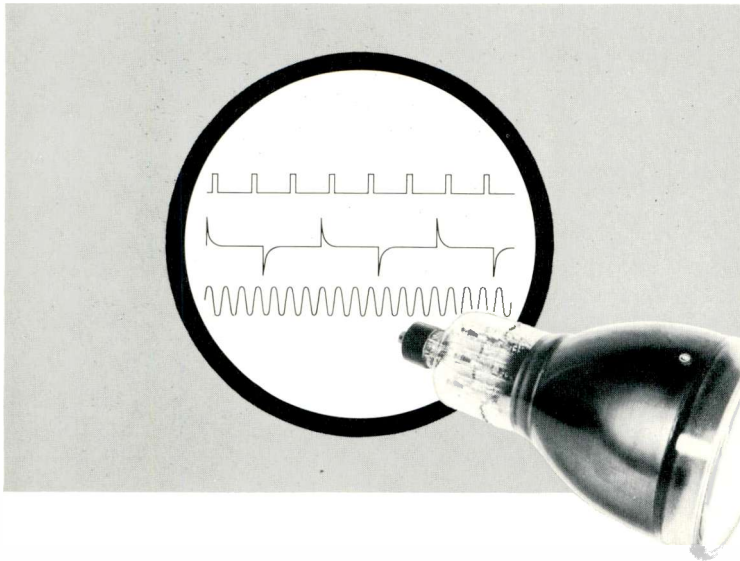

New Sylvania SC-3061 — multi-trace CRT

SC-3061 features three highly reliable, independently controlled electron guns capable of tracing three displays simultaneously on its 10" diameter face. The three guns focus undeflected spots $1\frac{3}{8}$ " apart on a common vertical line. The useful horizontal scan of each is approximately $8\frac{1}{2}$ ". SC-3061 is electrostatically focused and deflected and features an astigmatism control electrode. Deflection factors, at 5KV anode voltage, are approximately 130V/in. horizontal and 70V/in. vertical. SC-3061 uses P1 phosphor, but several other screen phosphors are also available.

Sylvania spiral accelerator tubes for precision 'scope applications

SYLVANIA-5BGP-, -5BHP- utilize an internal helical resistance coating to provide a uniform increase in accelerating voltage from deflection plates to the screen. They feature high-quality aluminized screens, high deflection sensitivity and accuracy, electrostatic deflection and focus. Both types can be supplied with a wide range of phosphors, all of which are rigidly controlled for premium characteristics.

Absolute Max. Ratings	5BGP-	5BHP-	Units
Anode No. 3 Voltage	13,200	13,200	Vdc
Isolation Shield Voltage	2,300	2,300	Vdc
Deflection Plate Shield Voltage	—	2,300	Vdc
Anode No. 2 Voltage	2,200	2,200	Vdc
Anode No. 1 Voltage	880	880	Vdc

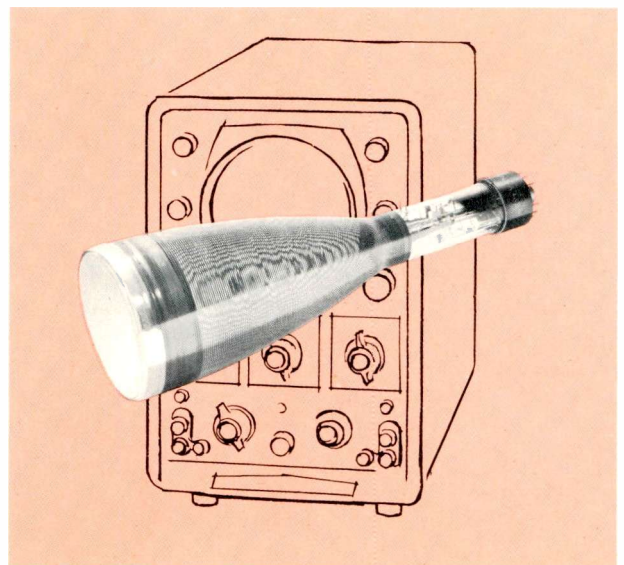

A	#	D	*	G	■	K	:	P	/	S	V	Y
B	\$	E	(H	√	?				½	¼	%
C	F)	!						10	×	.	;
N	"	Q	T				4	@	3	6	/	+
O	=	R	U	^	△	2	5	-	&	•	C	F

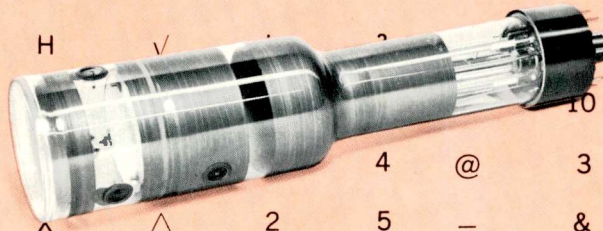

New Sylvania SC-3093 – 3" monoscope CRT for high-speed printing

Custom-built SC-3093 provides signal generation of characters to associated high-speed printing equipment. SC-3093 features electrostatic focus and deflection and provides a built-in 2" sq. target plate with a capability of 64 alpha-numeric characters. Similar monoscope tubes can be supplied to your specifications with a variety of black and white halftone patterns.

New Sylvania low-heater-power CRT's

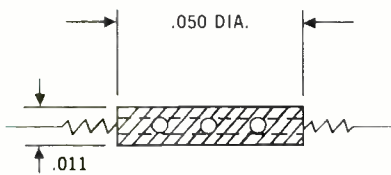

Developed by Sylvania, the new high-efficiency heater-cathode assembly consumes only 1.5 @ 140mA – less than 6% of the normal CRT heater power requirements. A flat pancake-like structure, 0.05" in diameter and 0.011" thick, it possesses extremely low mass, thereby enhancing resistance to shock and vibration. It is adaptable to practically all present-day CRT designs.

SYLVANIA -3BGP- offers high-deflection sensitivity, electrostatic deflection

and focus, optical-quality, clear, pressed faceplate. It is a compact, direct-view 'scope tube with face dimensions of 1½" x 3".

SYLVANIA -3BMP- is a 3" diameter tube with flat, clear faceplate. It offers post-deflection acceleration, electrostatic deflection and focus.

SYLVANIA SC-3016 features extremely compact size of only 6" in length and a circular face of 1½". It provides high-deflection sensitivity, electrostatic focus and deflection.



Key Characteristics	3BGP-	3BMP-	SC-3016	Units
Heater Ratings	1.5V/140mA	1.5V/140mA	1.5V/140mA	
Anode No. 3 Voltage		6600*		Vdc
Anode No. 2 Voltage	2750*	2200*	2750*	Vdc
Anode No. 1 Voltage	1100*	1500*	1100*	Vdc
Face Dimension	1½ x 3¼	3	1½	inches
Over-all length	9¼	10	6	inches

*Absolute max. ratings

Proven Sylvania capabilities in design and manufacture run the breadth and width of CRT applications – from highly sophisticated radar equipment to automobile ignition testers. The more than 200 Cathode Ray Tube types presently available represent only a small segment of Sylvania product capabilities. If your industrial-military design pre-

sents a CRT problem – look to Sylvania for solutions. Your Sylvania Sales Engineer will be pleased to work with you. For further information, contact the Sylvania Field Office nearest you. Or, for data on specific types, write Electronic Tubes Division, Sylvania Electric Products Inc., Dept. B, 1100 Main St., Buffalo, N.Y.

MICROWAVE DEVICE NEWS from SYLVANIA

NEW!



WR-75 waveguide ferrite isolators provide

- high isolation — low insertion loss
- low VSWR — exceptional compactness

FD-7516 — TYPICAL PERFORMANCE CHARACTERISTICS (25°C)

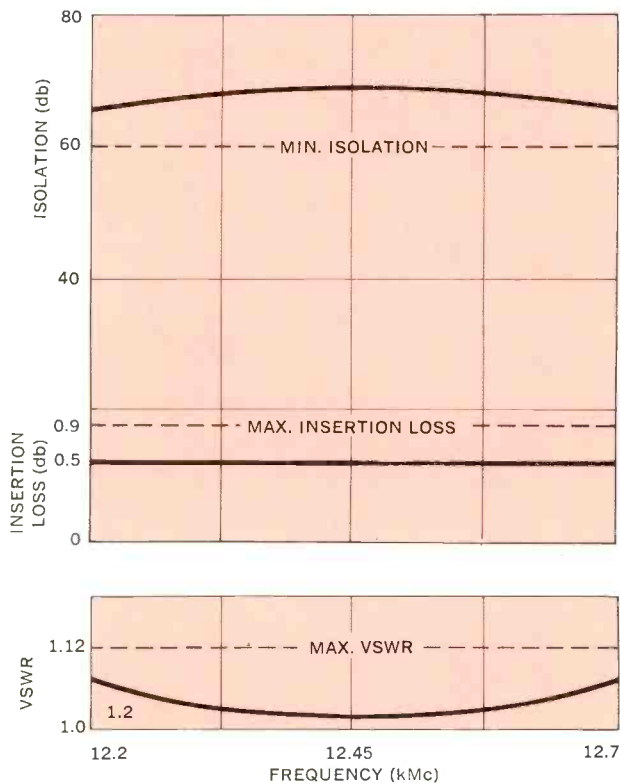

Sylvania introduces six new, narrow-band, high-performance ferrite isolators for common carrier and commercial microwave systems. Sylvania FD-7511, -7512, -7513, -7514, -7515, -7516 exhibit high isolation to insertion loss ratios, as much as 60 to 1 over a broad frequency range. Lengths are from 2½" to as short as 1½". Sylvania WR-75 Ferrite Isolators exhibit unusually low VSWR and excellent stability over a temperature range of -30°C to +60°C

Investigate the advantages of Sylvania's extensive ferrite device line for your microwave design. Contact your nearest Sylvania Field Office. Or, write Electronic Tubes Division, Sylvania Electric Products Inc., Dept. MDO-B, 1100 Main St., Buffalo 9, N. Y.

TYPE	FREQUENCY (KMC)		MIN. ISO-LATION (db.)	MAX. INSERTION LOSS (db.)	VSWR (Input & Output)	LENGTH (Inches)
	Min.	Max.				
7511	10.7	11.7	20	0.4	1.2	1½
7512	10.7	11.7	40	0.7	1.2	2
7513	10.7	11.7	60	1.0	1.2	2½
7514	12.2	12.7	25	0.4	1.12	1½
7515	12.2	12.7	40	0.6	1.12	2
7516	12.2	12.7	60	0.9	1.12	2½

SYLVANIA

Subsidiary of **GENERAL TELEPHONE & ELECTRONICS** 

"NO NEEDLESS NINES"

For Speed Where It Counts in New 'NLS 30' Digital Voltmeters



Transistorized "no-needless-nines" logic makes the new V35A and V34A digital voltmeter-ratiometers at least three times faster than meters with older type logic . . . and you get this speed where it counts, in systems applications with varying input signals. The five-digit V35A's *maximum* balancing time is 2.3 seconds and the four-digit V34A's 1.9 seconds — no matter how much the input signal varies. Under like conditions, all other stepping switch digital voltmeters require 10, 15, 20 seconds or more — depending on variation of inputs. Only NLS new Series 30 instruments offer you the many other benefits of "no-needless-nines" logic, plug-in oil-bath stepping switches, 99% plug-in modular construction, and eight other *new* features. Contact NLS today for the full story on "no-needless-nines" logic and Series 30 instruments.

V35A SPECIFICATIONS: Measures DC voltage from ± 0.0001 to ± 999.99 , DC voltage ratio from $\pm 00.001\%$ to $\pm 99.999\%$. . . accuracy: $\pm 0.01\%$ of reading or ± 1 digit for DC voltage, $\pm 0.005\%$ of reading or ± 1 digit for DC ratio . . . output and internal automatic controls for data recording . . . measures AC voltage and low-level DC with accessories . . . completely automatic . . . plug-in transistor circuitry throughout, including logic . . . no adjustment needed to read noisy signals or to change ratio reference voltage value . . . interchangeable plug-in stepping switches sealed in oil . . . the "Factual Fifth Figure", which means a full 5-digit resolution of 0.001% over the entire range . . . "No-Needless Nines" logic . . . remote, local, or automatic AC/DC switch-over and range changing . . . front and rear input connectors . . . 10 megohms impedance on DC voltage, 1000 megohms on voltage ratio . . . \$3,750, complete. V34A (4-digit version) is \$3,150, complete.



Originator of the Digital Voltmeter

non-linear systems, inc. DEL MAR, CALIFORNIA

LIGHT WEIGHT

CHECKMATE

in wire capping



STRONG



NEW *heat-shrinkable....*

THERMOFIT CAPS



RAYCLAD TUBES
INCORPORATED

A SUBSIDIARY OF
RAYCHEM
CORPORATION

THERMOFIT CAPS are short, irradiated polyolefin sleeves, sealed on one end, which shrink to less than one-half of their original diameter upon the brief application of heat. Upon shrinking, they produce a tough, moisture-tight end-seal with outstanding insulation properties for the most difficult environments.

THERMOFIT CAPS reduce required space to a minimum; conform to variable contours; provide quick and uniform application; are available in standard color-coded sizes; and are low in price.

OAKSIDE AT NORTHSIDE • REDWOOD CITY • CALIFORNIA

News Briefs

Capsule summaries of important happenings in affairs of equipment and component manufacturers

EAST

ITEK CORP., Waltham, Mass., is buying from M. Steinthal & Co., and CBS Laboratories their joint venture company, Space Recovery Systems, Inc., Los Angeles, Calif.

GIRDLER PROCESS EQUIPMENT, division of Chemetron Corp., has moved its headquarters, Sales and Engineering offices to new quarters at 2820 W. Broadway, Louisville, Ky.

FEDERAL PACIFIC ELECTRIC CO., Newark, N. J., has reorganized its manufacturing operations, integrating 16 of its U. S. plants into 3 regional groups—Eastern, Central and Western.

ATLEE CORP., Waltham, Mass., has combined with its separately operating companies, namely, Wesco Electrical Co., Inc., Applied Dynamics Corp., and Industrial Electronics Co., Inc.

COLUMBIA TECHNICAL CORP. has opened a 28,000 sq. ft. plant at 24-30 Brooklyn-Queens Expressway W., Woodside, N. Y.

CALEDONIA ELECTRONICS & TRANSFORMER CORP., Caledonia, N. Y., and **ELECTRO NETWORKS, INC.**, Syracuse, N. Y., have jointly announced the merger of their companies. Combined operations will be at the 50,000 sq. ft. facility in Caledonia.

ENGINEERING INFORMATION ASSOCIATES, INC., a new engineering and technical writing company, has opened offices in the Gurley Bldg., 322 Main St., Stamford, Conn.

PEERLESS RADIO DISTRIBUTORS, Jamaica, N. Y., has acquired a new 25,000 sq. ft. building in Lynbrook, L. I., N. Y., to house their Industrial Electronic Sales Division.

ACCURATE SPECIALTIES CO., INC., a semiconductor materials manufacturer, has opened a modern 15,000 sq. ft. one-story plant at 345 Lodi St., Hackensack, N. J.

MEGADYNE ELECTRONICS, INC., Danbury, Conn., stockholders, have voted to approve a merger with CWS Waveguide Corp., Lindenhurst, L. I. CWS Waveguide shareholders had already ratified the proposed merger. Name of the new combined company will be Megawave Electronics Corp.

SANDERS ASSOCIATES, INC., Nashua, N. H., has begun operations in its new 50,000 sq. ft. Plainview, L. I., plant.

CERAMICS INTERNATIONAL CORP., has been established in Mahwah, N. J., to manufacture ceramic-to-metal fabrications for the electronics industry.

ALADDIN ELECTRONICS is building a new air-conditioned 3-story plant just south of its present headquarters on Murfreesboro Rd., Nashville, Tenn. The 18,000 sq. ft. building will house engineering and manufacturing departments producing miniature transformers, inductors, discriminators.

GULTON INDUSTRIES, INC., will add 40,000 sq. ft. of space to its plant in Metuchen, N. J., for new executive and administrative offices and two research laboratories, as well as a manufacturing area.

GENERAL ELECTRIC, ADVANCED SEMICONDUCTOR LABORATORY, Liverpool, N. Y., has been organized into five principal research areas: Materials Studies, Measurement Studies, Surface Studies, New Structure Studies, and Micro Devices Studies Unit.

GENERAL PRECISION, INC., has formed an advanced Systems Planning Group in Aeronautics and Space Operations. It will be headquartered in Washington, D. C.

ACTON LABORATORIES, INC., Acton, Mass., has changed its name to Technology Instrument Corp. of Acton to simplify marketing of its product lines, consisting of measurement and control instrumentation; rocket, missile, and satellite instrumentation and systems, and communications equipment.

RMS ASSOCIATES, Mamaroneck, N. Y., has reorganized and expanded to develop and manufacture electronic equipment, having previously fabricated custom electronic and electromechanical equipment on a sub-contract basis.

COLUMBUS ELECTRONICS CORPORATION, manufacturers of double-diffused silicon rectifiers, has moved into its newly equipped 30,000 sq. ft. production facility at 1000 Saw Mill River Road, Yonkers, N. Y., and is now in full production.

THE GARRETT CORP.'s New York branch office has moved from Mineola, L. I., N. Y., to 600 Old Country Rd., Garden City, L. I., N. Y. This office serves New York, Connecticut and New Jersey.

CLEVITE ELECTRONIC COMPONENTS, division of Clevite Corp., has established a new branch sales office in Maplewood, N. J. Address is 2130 Millburn Ave.

TELECTRO INDUSTRIES CORP., New York, has formed an affiliate, Telectro-Mek, Inc., to develop and manufacture proprietary electronic and electro-mechanical products for determining and controlling jet aircraft engine performance.

MIDWEST

MINNESOTA MINING & MFG. CO. and **WARNER - LAMBERT PHARMACEUTICAL CO.**, have suspended plans to combine the two companies until clearance is received from the Dept. of Justice.

DORSETT ELECTRONIC LABORATORIES, INC., Norman, Okla., has acquired all the outstanding shares of American Missile Products, Inc., Lawndale, Calif., formerly the Electronics Div. of the Maytag Co., Newton, Iowa.

SHURE BROS., INC., has started building a 38,000 sq. ft. addition to its Evanston, Ill., plant.

HANCOCK TELECONTROL CORP., a new company, has acquired the Telecontrol Division of Hancock Industries, Inc., of Jackson, Mich.

ELECTRONIC ASSISTANCE CORP., Red Bank, N. J., has formed a Systems Engineering Division and established a 22,000 sq. ft. centre on an 18-acre plot for research at Ann Arbor, Mich.

BURTEK, INC., Tulsa, Okla., has acquired Concord Control, Inc., Boston, Mass., specializing in digital computation, data handling, and control-systems engineering, from the Giddings & Lewis Machine Tool Co., Fond du Lac, Wis.

THE PIONEER ELECTRIC & RESEARCH CORP., Forest Park, Ill., has acquired solid-state photo conductor engineering and manufacturing facilities by merging with JEM Electronics Corp., Forest Park.

MAGNAFLUX CORP., Chicago, subsidiary of General Mills, has acquired Metal Control Laboratories, Los Angeles.

WEST

BECKMAN INSTRUMENTS, INC., is building a new 100,000 sq. ft. plant to house its Systems Division at the Company's Fullerton, Calif., headquarters location. Occupancy is scheduled for May 1, 1961.

HOFFMAN ELECTRONICS CORP., Los Angeles, has formed a new International Trade Dept. to administer and promote the company's expanding overseas activities.

LITTON SYSTEMS, INC., has established new regional technical applications staff offices in Beverly Hills, Calif., and Waltham, Mass.

MICROSEMICONDUCTOR CORP., has been established to conduct research and development and manufacture of semiconductors. Headquarters is a 15,000 sq. ft. facility in Culver City, Calif.

LEAR, INC., Santa Monica, Calif., has established a new International Div. Headquarters of the new division is in Santa Monica, Calif.

RADIATION, INC., Melbourne, Fla., has changed the name of its subsidiary, Levinthal Electronic Products, Inc., to "Radiation at Stamford." Located in Stamford Industrial Park, Palo Alto, Calif., it will remain a subsidiary of the parent company.

DEEM ENGINEERING CO., has been formed and will conduct business from general offices at 3785 E. Olympic Blvd., Los Angeles 23, Calif., to provide the aircraft and missile industries with a specialized design capability for electronic and electromechanical countermeasures and other auxiliary weapon systems equipments.

UNION TEXAS NATURAL GAS CORP., Houston, Tex., will enter the field of applied physics and advanced electronics through a newly formed company, Quantatron, Inc., of Santa Monica, Calif.

CRESCENT ENGINEERING & RESEARCH CO., has signed an agreement to acquire all outstanding stock of the Travis Plating Co., Los Angeles.

RHEEM MFG. CO. has taken a 20-year lease on a new 100,000 sq. ft. building at Mountain View, Calif., for its subsidiary, Rheem Semiconductor Corp.

FORD MOTOR CO.'s Aeronutronic Div., has changed the name of its research operation to Research Laboratories.

SPACE ELECTRONICS CORP. is adding 37,000 sq. ft. to its facilities at Flower St. & Air Way, Grand Central Industrial Park, Glendale, Calif.

ROBERTS ELECTRONICS INC., 829 No. Highland Ave., Los Angeles, is building a new plant at 5918 Bowcroft Ave., Los Angeles to house administrative offices, engineering and warehousing facilities. The 50,000 sq. ft. building will cost \$1 million.

RYAN AERONAUTICAL CO., has purchased 20½ acres including the Kearny Mesa (San Diego), buildings and site of its electronics plant, which has been on a lease basis for the past 3 years from Magnatron Corp. of America, Inc.

BAWCOCK ELECTRONICS CORP. is adding 30,000 sq. ft. of new manufacturing area, to be used for machine shop and relay assembly operations, to its Costa Mesa facilities in California.

The industry's broadest line of COMMUNICATIONS TRANSISTORS

PHILCO COMMUNICATIONS TRANSISTORS

Frequency	RF Amplifiers	IF Amplifiers	Mixers and Converters	Low-Level Oscillators	High-Level Oscillators	Multipliers	Audio or Video Amplifiers
0-20 KC							2N223 2N224 2N226 2N387 2N207 2N159 2N535 2N557 2N600
20 KC-2 MC	2N1789 2N1785 2N1126 2N1267 2N773 2N393 2N344 2N346	2N1728 2N1747 2N1865 2N1859 2N1867 2N1790 2N1267 2N773 2N346 2N393	2N1227 2N1786 2N1789 2N1267 2N344 2N773 2N346 2N1267 2N393 2N346	2N1227 2N1786 2N1789 2N1267 2N344 2N773 2N346	2N1158A 2N1867 2N597 2N1267 2N773	2N1867 2N1267 2N773	2N597 2N600 2N1267 2N773 2N393 2N1788 2N1749
2-10 MC	2N1747 2N1867 2N1746 2N1267 2N346	2N1747 2N1869 2N1866 2N1867 2N1267 2N773 2N146	2N1746 2N1747 2N1865 2N1866 2N1867 2N1867 2N1267 2N773 2N346	2N1746 2N1268 2N1789 2N1866 2N1267 2N773 2N346	2N1158A 2N1867 2N1267 2N773	2N1747 2N1867 2N1267 2N773	2N1267 2N600 2N1749 2N1749 2N1746 2N1270 2N776 2N502A
10-30 MC	2N1745 2N1747 2N1867 2N502A 2N585 2N1270 2N776	2N1745 2N1866 2N1867 2N1747 2N502A 2N585 2N1270 2N776	2N1745 2N1866 2N1867 2N1867 2N1747 2N502A 2N585 2N1270 2N776 2N346	2N1747 2N1867 2N502A 2N585 2N1270 2N776 2N346	2N1158A 2N1270 2N776	2N1744 2N1747 2N1867 2N1270 2N1158A	2N1745 2N502A 2N1745 2N1745 2N1270 2N776
30-70 MC	2N1742 2N1745 2N502A 2N1270 2N1770	2N1745 2N1868 2N1745 2N502A 2N1270	2N1743 2N1745 2N502A 2N1270 2N776	2N1744 2N502A 2N1270 2N776	2N1158A 2N1270 2N776	2N1158A 2N1244 2N1270 2N776	2N1742 2N502A 2N1270 2N776 2N769
			5431	15431	15431	15431	742

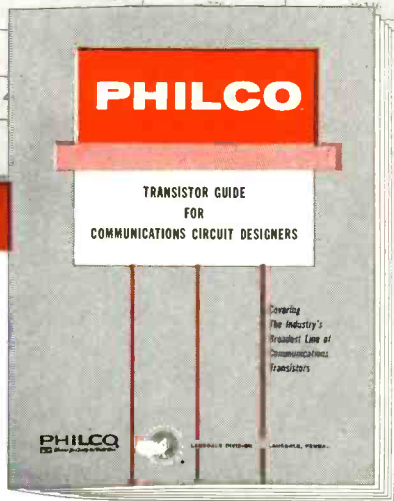

You'll find one Exactly Right for your requirements

Whatever your specific requirements . . . in gain, noise figure, AGC and other electrical characteristics . . . you'll find a Philco communications transistor that meets your needs precisely.

Unlike other manufacturers, who offer only limited lines of "general-purpose" transistors, Philco designs and produces transistors to meet specific requirements. Philco can do this only because the exclusive Philco Precision-Etch* process of manufacture permits precise control of all parameters and absolute uniformity.

To increase circuit efficiency and reliability, to reduce cost and to make your design easier . . . look first to the Philco line, which offers you the industry's widest range of communications transistors. You'll find one *exactly right* for your requirements.

*Trademark Philco Corp.

NEW! Transistor Guide for Communications Circuit Designers

To make it faster and easier for you to find the Philco communications transistor that best meets your needs, put this new guide to work for you. 12 pages of application information, descriptions of major types and a complete selector chart will speed your work. For your copy, write Dept. EI261.

Philco Transistors are immediately available in quantities 1-999 from your Philco Industrial Semiconductor Distributor.

PHILCO®



Famous for Quality the World Over

LANSDALE DIVISION • LANSDALE, PENNSYLVANIA

Circle 11 on Inquiry Card



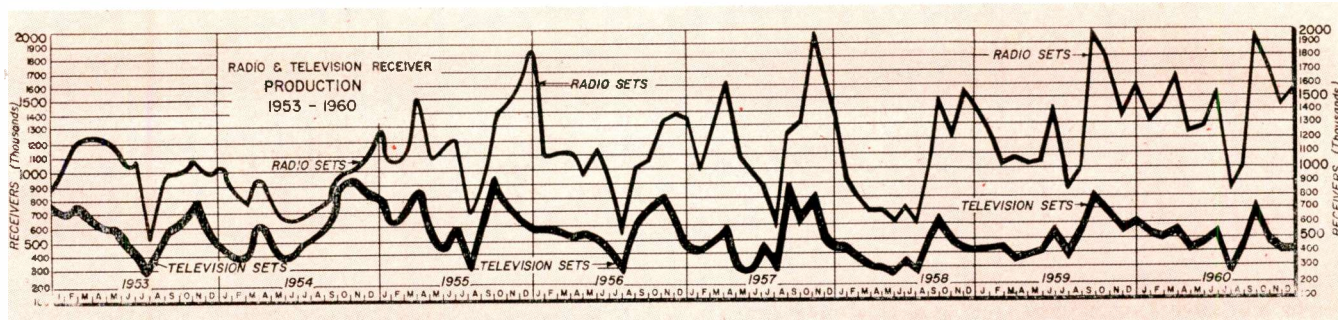

ELECTRONIC COMPONENT INDUSTRY OPERATING RATIOS OR AVERAGES, BY SELECTED COMPONENTS AND MAJOR GEOGRAPHICAL AREAS¹

	Ave. annual dollar shipments per employee	Square feet of floor space per employee	Percent of engineers and scientists to total employment
Power and special-purpose tubes	10,000	205	9.9
Receiving tubes	8,600	105	3.7
Television picture tubes	14,700	280	5.5
Semiconductors	8,030	300	214.1
Capacitors	6,800	230	4.1
Connectors	10,500	180	2.7
Microwave components	10,500	225	n.a.
Quartz crystals	6,900	205	4.6
Relays	9,200	155	3.4
Resistors	8,960	175	5.6
Transformers	9,750	320	3.7
Average ³	9,100	180	5.0
New England	7,400	195	4.6
Middle Atlantic	9,100	190	6.0
South	9,900	125	1.8
Midwest	10,650	205	4.4
West	9,100	155	8.4

n.a.—Not available.

¹ 1956 data except for microwave components, which are 1958 data.

² This high figure was due to relatively low levels of output in 1956 in relation to research and development activity.

EPR/BDSA Joint Semiannual Survey of Production Capabilities for Electronic Parts; Microwave Components, Production and Related Data, 1958; and other sources.

GOVERNMENT ELECTRONIC CONTRACT AWARDS

This list classifies and gives the value of electronic equipment selected from contracts awarded by government agencies in December, 1960.

Amplifiers	1,230,410	Fuseholders	31,532	Relay assemblies	50,833
Amplifiers, magnetic	85,585	Ground stations, telemetry	39,613	Relay, solenoid	26,010
Amplifiers, parametric	92,332	Gyroscopes	2,791,430	Relay, undervoltage	38,016
Amplifiers, synchro signal	657,413	Indicators-amplifiers	56,133	Resistors	647,668
Analyzers, distortion	38,673	Inverters	548,542	Servos	225,390
Antennas	54,385	Inverters, rotary	67,528	Solenoids	41,810
Assemblies, demultiplexer	269,039	Meters, frequency	26,386	Standards, frequency	37,328
Assemblies, tape	26,000	Meters, volt	88,722	Switches	264,836
Batteries, dry	104,184	Meters, watt	43,882	Synchros	282,169
Cable	63,120	Microphones	243,927	Systems, communications	1,088,352
Cable assemblies	94,506	Microscopes, electron	33,233	Systems, recording, strain gage	31,236
Cable, coaxial	43,770	Modules, r-f	58,240	Telemetering sets	185,158
Cable, r-f	61,800	Motors, servo	165,573	Test sets, amplifier	43,035
Calibrators, transducer	59,385	Oscillators, r-f	146,997	Test sets, cable	100,200
Cavity, tuned	27,026	Oscilloscopes	51,000	Test sets, oscillator	43,170
Communications systems	237,239	Power supplies, dc	64,047	Test sets, radio	37,950
Computers	593,285	Power supplies, r-f	251,653	Transformers	213,963
Connectors	36,424	Probes, temperature	54,948	Transformers, synchro control	37,666
Controls, interphone	50,138	Radars, height finding	2,802,760	Transmitters	159,123
Converters, frequency shift	151,740	Radio links	33,369	Transmitters, i-f	73,050
Crystal units	102,900	Radio sets	2,508,065	Transmitters, L-band	150,258
Diodes, semiconductor	78,375	Receivers, homing	410,612	Transmitters, UHF	184,220
Direction finders, radio	121,250	Receivers, radio	146,740	Transponders	1,359,452
		Receivers, range monitor	26,317	Tubes, cathode ray	42,883
		Recorders, data	479,598	Tubes, electron	211,243
		Recorders/reproducers	575,606	Tubes, klystron	58,831
		Recorders, video tape	437,981	Tubes, magnetron	160,980
		Relays	205,735	Tubes, traveling wave	47,425
		Relays, armature	160,996	Tuners	90,144

WAIT A MINUTE... or a μ SECOND

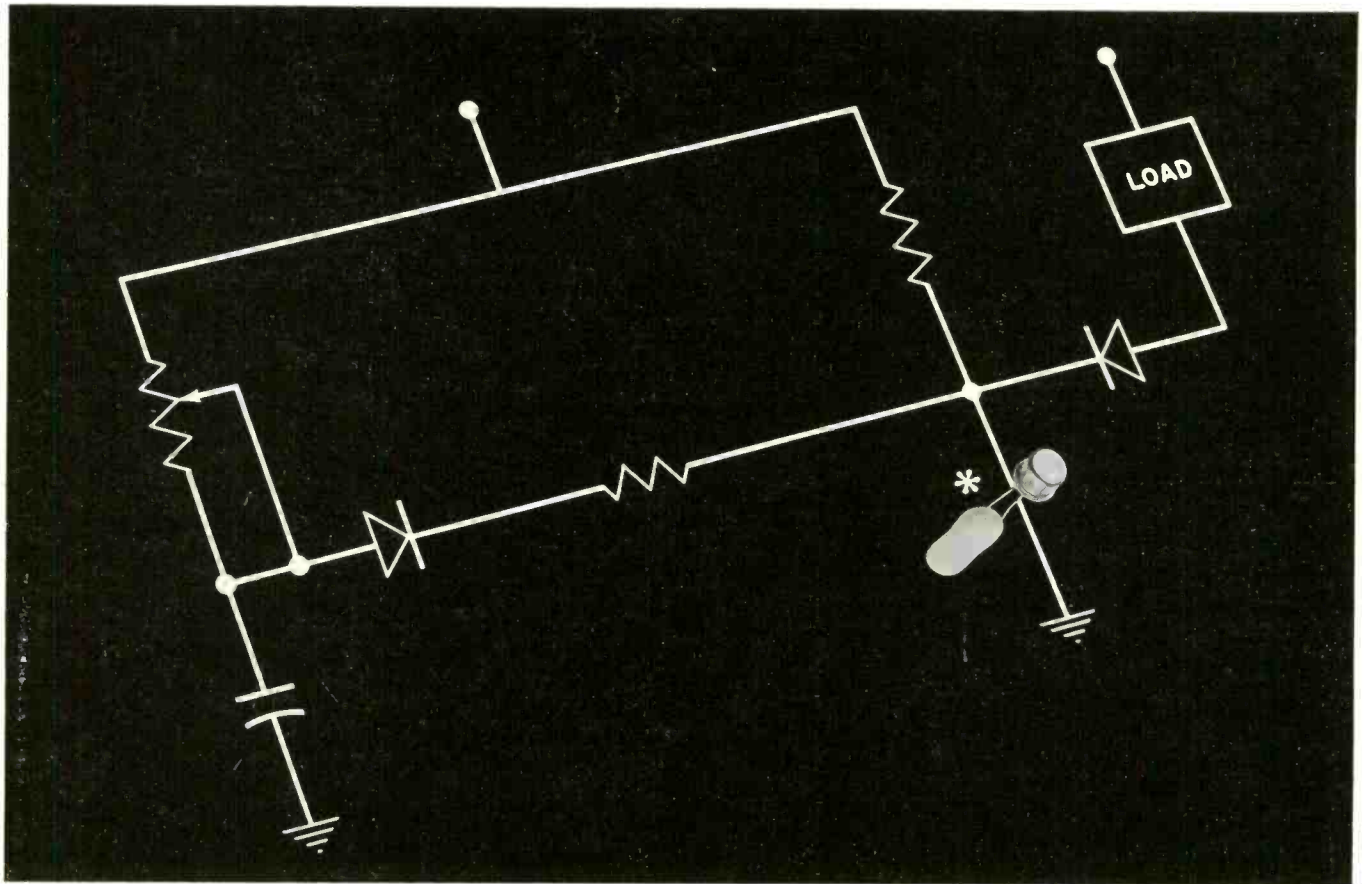

SHOCKLEY 4-LAYER DIODE gives minutes or μ s time delays with a single circuit.*

A wide variety of time delays from fractions of a microsecond to several minutes have been made possible by the Shockley 4-layer diode. Now you have the advantages of solid state circuitry for a wide range of industrial and military time delay or time cycle applications.

You'll see in the schematic drawing above that only one active element is needed in this circuit: the Shockley 4-layer diode. The Type AD shown will carry 300 ma continuously. Higher power diodes are available. Contact bounce and chatter are entirely eliminated since mechanical devices are no longer necessary.

If you are developing a circuit where a variable time delay is needed (to energize relays, to activate a power supply or to obtain timing pulses), contact our local engineering sales representative for details, or write to Shockley Transistor, Palo Alto.

Shockley TRANSISTOR

UNIT OF CLEVITE TRANSISTOR
STANFORD INDUSTRIAL PARK, PALO ALTO, CALIF.



You decide...

WHAT THE NEW IMPEDANCE BRIDGE CAN BEST DO FOR YOU...



- Precision laboratory measurements
- Incoming inspection of components
- Production line testing
- Field engineering and aero flight tests
- Limits bridge
- Three terminal capacitance measurements
- Capacitor leakage measurements (to 500 V.D.C.)
- Very low capacitance differential measurements (to 0.01 uufd)



UNIVERSAL IMPEDANCE BRIDGE

MODEL 710A

FEATURES

- Total weight under 10 lbs.*
- High accuracy*
- Wide range*
- Direct in-line readout*
- Plug-in frequency networks*

The Model 710A is the most compact, versatile, and easy to operate precision impedance bridge available today.

Because its internal ratio arm resistors and capacitance standard are selected for highest stability, the 710A also assures you the utmost in reliability and long life.

PARTIAL SPECIFICATIONS

Resistance:	0-12 megohms in 8 ranges.	Storage Factor (Q):	0 to 1000 at 1 kilocycle.
Accuracy:	±(0.1% + 1 dial division)	Accuracy:	±(2% + 0.005)
Capacitance:	0 to 1200 microfarads in 7 ranges.	SWITCHES:	All switches use silver alloy contacts to insure the highest accuracy.
Accuracy:	±(0.2% + 1 dial division)	INPUT POWER:	115/230 volts, 50 to 800 cycles, 12 watts.
Inductance:	0 to 1200 henrys in 7 ranges.	DIMENSIONS:	Cabinet length, 9 inches; width, 7 inches; height, 6½ inches.
Accuracy:	±(0.3% + 1 dial division)		
Dissipation Factor (D):	0 to 1.000 at 1 kilocycle.		
Accuracy:	±(2% + 0.005)		

ADDITIONAL SPECIFICATIONS AND APPLICATION NOTES ARE AVAILABLE
Please circle this ad number on the inquiry card or write direct for additional information.

ACTUAL CABINET SIZE indicated by black border.

PRICE:
\$525.00 net F.O.B. factory
Seattle, Washington

Price and specifications subject to change without notice.



JOHN FLUKE MANUFACTURING CO., INC.

P. O. Box 7161

Seattle 33, Washington



CUDDLY MONSTER

Arms of Robot Mark II, mobile robot built by Hughes Aircraft Co., Culver City, Calif., embrace Colleen Adams in a demonstration of its almost human actions. Remote-controlled handling machine substitutes for man in dangerous places, e.g. radioactive areas.

DOPPLER RADAR FOR "HUSTLER"

Doppler radar for the Air Force's B-58 "Hustler" bomber are part of Sperry Gyroscope Co. systems that automatically navigate the supersonic aircraft and control precise release of armament. Raytheon Co.'s Airborne Equipment Div. makes the radars.

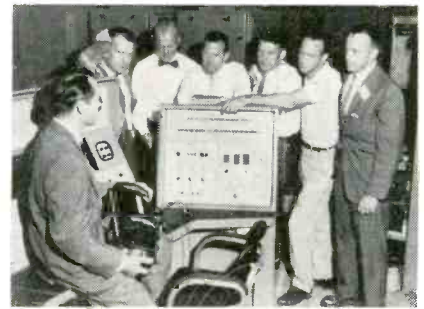
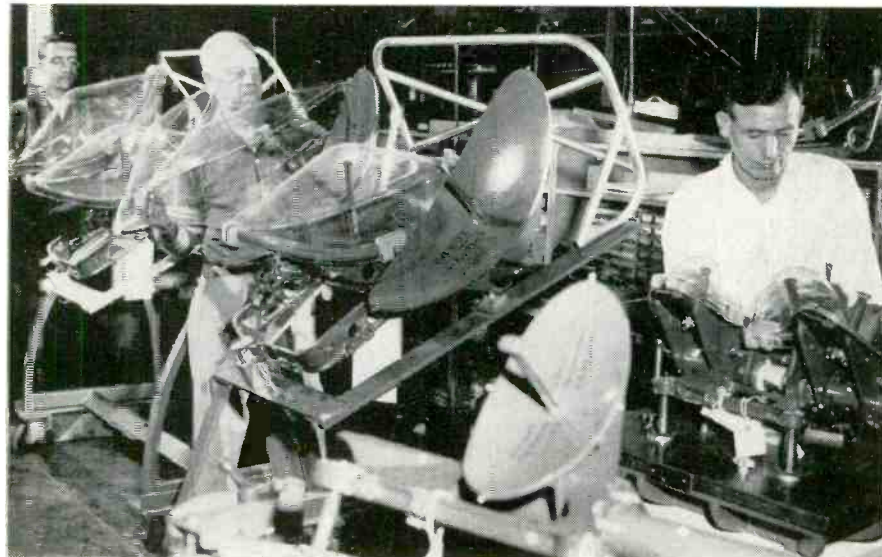

ASTRONAUTS

GE's Defense Systems Dept. and Burroughs Corp. demonstrate radio-command guidance system to six Project Mercury astronauts. GE's H. B. Hooper points out features of the lightweight airborne track beacon.

Snapshots of the Electronic Industries

SHOPPING LIST?

The three and a half million items managed by the Defense Dept. are electronically cataloged on these 60 reels of magnetic tape. An IBM 705 III at the Armed Forces Supply Support Center updates items.



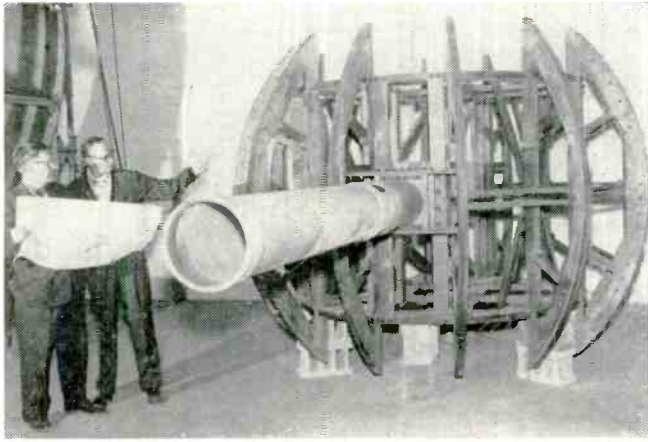

VARIOMETERS

E. T. Rogers, Engineering VP, and P. O. Doorley, Production VP, Permal, Inc., Mt. Pleasant, Pa., check out non-metallic rotor structure for one of two variometers built for the Navy's VLF radio transmitter at Cutler, Me. Installation will transmit to submerged submarines.

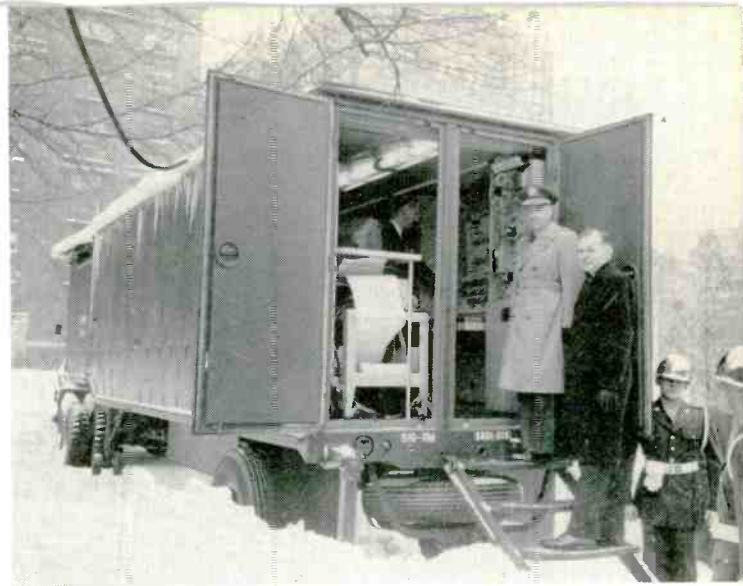

MOBIDIC DEMONSTRATION

Army shows large scale mobile computer for battlefield use. MOBIDIC (Mobile Digital Computer) was developed by Sylvania Electric Products, Inc. Brig. Gen. J. C. Monahan, Ch. U. S. Army Sig. Corps' R & D Div., and H. Lehne, a senior VP at Sylvania, are on vehicle's steps.



CRAZY BUMPER

E. Bradley, Special Products Mng'r., Melpar, Inc., adjusts "Road Eye"—a Lateral Displacement Detector which will measure normal driving deviations in a new Bureau of Public Roads highway safety program.

TEST SOLAR CELLS

Photofloods are used to test the 9,260 solar cell battery for Tiros II supplied to RCA by International Rectifier Corp. Cage (above R. Wilkes, RCA engineer) creates magnetic field like the field surrounding the earth in space. Cells last indefinitely.

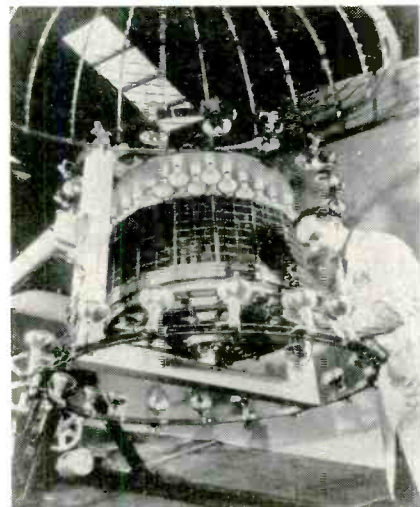

ULTRAVIOLET TRANSMISSION

Experimental Westinghouse system for transmitting video information via modulated ultraviolet radiation. Demodulated signal from TV camera (to left of subject) produces image on receiver at the rear.



SATURN BOOSTER

Second Saturn booster assembly fixture nears completion at the George C. Marshall Space Flight Center. Booster can be seen framed within the forward gantry of the new fixture. Progressive Welder & Machine Co. made the Center designed fixture.

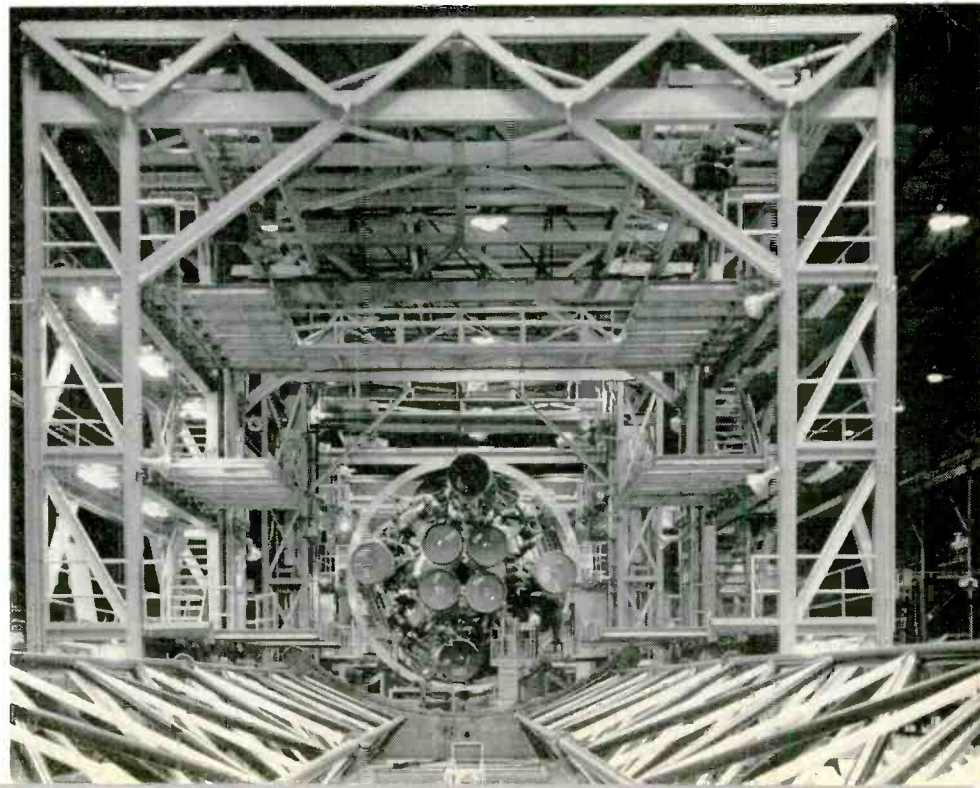

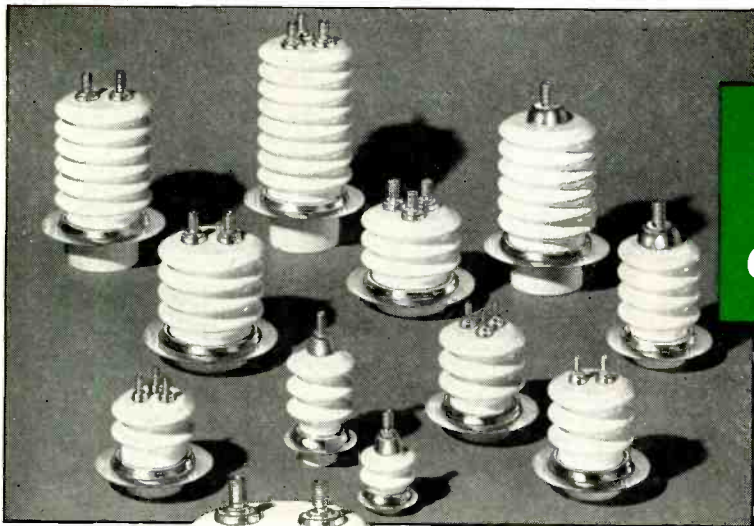

ALITE®

CERAMIC-TO-METAL SEALS

*Standard Bushings
or Special Designs*

FROM ONE COMPLETELY INTEGRATED SOURCE



ALITE — with its completely equipped facilities for producing high quality, vacuum-tight, ceramic-to-metal seals — is geared to meet all your requirements for high alumina ceramic-metal components. From design to finished assembly, every manufacturing step — including formulating, firing, metalizing and testing — is carefully supervised in our own plant. Result: effective quality control and utmost reliability.

Hermetic seals and bushings made of high alumina Alite are recommended for electromechanical applications where service conditions are extremely severe or critical. Alite has high mechanical strength and thermal shock resistance. It maintains low-loss characteristics through a wide frequency and temperature range. It resists corrosion, abrasion and nuclear radiation. Its extra-smooth, hard, high-fired glaze assures high surface resistivity.

To simplify design problems and speed delivery, Alite high voltage terminals, feed-throughs and cable end seals are available in over 100 standard sizes. However, when specifications call for special units for unusual applications, you can rely on expert assistance from Alite engineers to help you take full advantage of Alite's superior properties.

Write us about your specific requirements today.

WRITE FOR HELPFUL FREE BULLETINS

Bulletin A-7R gives useful comparative data. Bulletin A-40 describes Alite facilities and complete line of Alite Standard Bushings.



ALITE DIVISION

U. S. STONWARE

BOX 119

ORRVILLE, OHIO

New York Office — 60 East 42nd St.

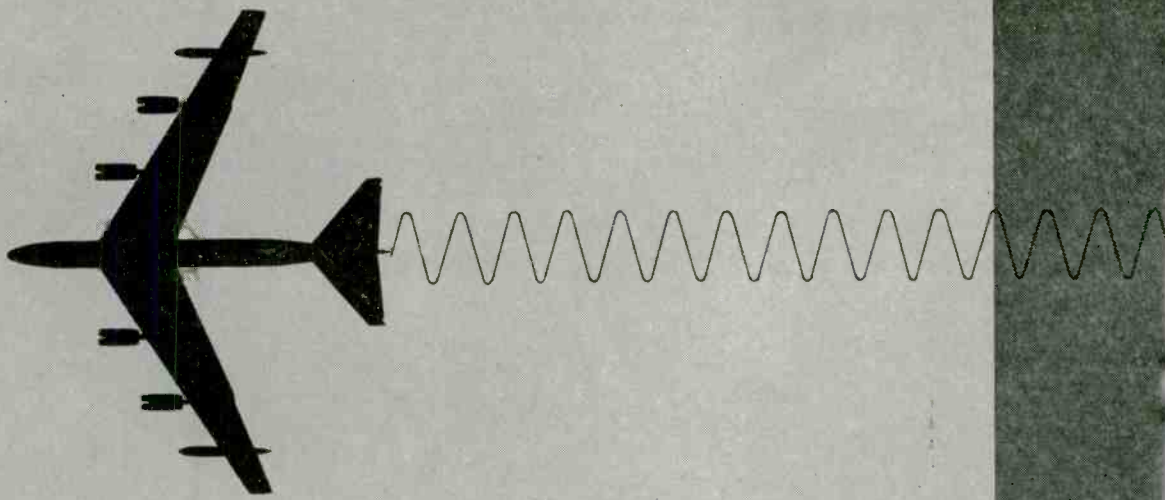

Raytheon Subminiature Tubes Help Deliver The Message for Hughes Project Tattletale

Enemy atomic attack can scramble the ionosphere disrupting vital communications. The Air Force provides a solution in the form of Project Tattletale. A high altitude rocket containing a taped message and transmitting equipment is shot 300 miles up to provide a straight-line transmission requiring no ionospheric bounce.

PROBLEM: How to assure maximum reliability during transmission.

SOLUTION: Hughes Aircraft Com-

pany, contractor, chose Raytheon 5702WA, 5703WA, and 6021 Reliable Subminiature Tubes.

If your designs require tubes featuring reliable operation, long life, and stable performance under severe conditions of high temperature and mechanical shock or vibration, Raytheon Reliable Subminiature Tubes can offer an immediate solution. For complete technical data, please write to Raytheon, Industrial Components Division, 55 Chapel St., Newton 58, Mass.

For Small Order or Prototype Requirements See Your Local Franchised Raytheon Distributor

RAYTHEON COMPANY

INDUSTRIAL COMPONENTS DIVISION

Circle 15 on Inquiry Card

RAYTHEON

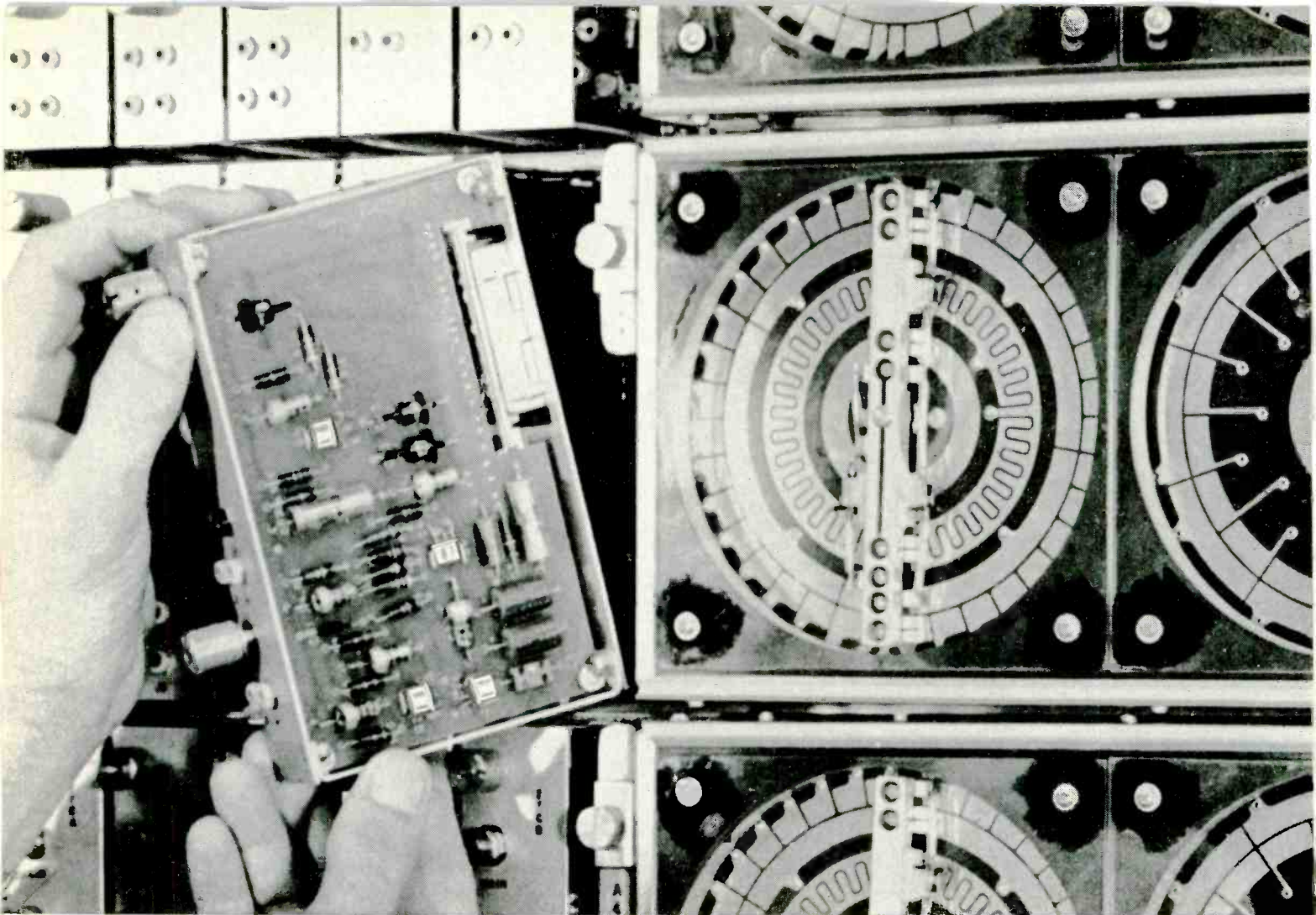

chooses Tung-Sol transistors for automatic air traffic control vocal system

The Cook Electric Automatic Voice Relay is an integral part of a highly advanced system known as Volscan which is designed to relieve the hazards of air traffic congestion over modern airports. The AVR automatically generates flight path instructions vocally to pilots waiting to land, on the basis of data submitted to it by radar. A plane can be brought in every 30 seconds by the system.

Naturally, the highly critical nature of the system's function demanded that components selected to operate in the system meet the highest reliability standards. For this critical amplification and detection circuits in the AVR, Cook specified Tung-Sol transistors. More than 2000 Tung-Sol 2N461 germanium transistors were assigned to these significant tasks. Cook stipulated the reasons for selecting Tung-Sol: "We found

that Tung-Sol transistors more than satisfied the high reliability requirements for this operation. Moreover, Tung-Sol was able to meet a rapid delivery schedule."

Why don't you get the benefit of Tung-Sol component knowledge and experience too? Tung-Sol components — whether transistors, tubes or silicon rectifiers — fill virtually every commercial and military application with unexcelled dependability. Tung-Sol applications engineers will be glad to recommend the best components for your design. Tung-Sol Electric Inc., Newark 4, New Jersey. TWX:NK 193.

Technical assistance is available through the following sales offices: Atlanta, Ga.; Columbus, Ohio; Culver City, Calif.; Dallas, Texas; Denver, Colo.; Detroit, Mich.; Irvington, N. J.; Melrose Park, Ill.; Newark, N. J.; Philadelphia, Pa.; Seattle, Wash. Canada: Toronto, Ont.

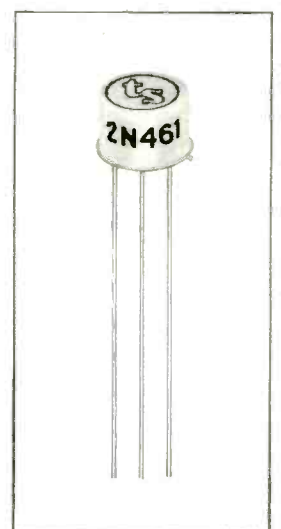

TUNG-SOL®

Circle 16 on Inquiry Card

U. S.-Jap Government's OK Litton-Kobe Kogyo Pack

Kobe, Japan—The U. S. and Japanese governments have approved a technological assistance and licensing agreement between Litton International S. A., Zurich, Switzerland, and Kobe Kogyo Corp., Kobe, Japan. Litton International is a wholly-owned subsidiary of Litton Industries, Inc.

The agreement establishes a long-term working relationship in the microwave tube field. Kobe Kogyo will make Litton tubes for customers in Japan and other Asian countries. Litton International receives an equity position in Kobe Kogyo, a royalty fee (undiscounted amounts), and U. S. distribution rights for tubes made by the Japanese firm except for home entertainment set tubes.

Marconi—Computer Firm Sign License Agreement

Sylmar, Calif.—Computer Measurements Co., division of Pacific Industries, Inc., has licensed Marconi Instruments, Ltd., (England) to manufacture and sell their transistorized electronic counters in European markets.

The agreement covers Computer Measurements' line of 10, 20, and 100 MC solid state counters used in commercial and defense electronics applications. The 10-year agreement includes exchange of engineering data aimed at improvements in solid-state technology.

New ICAO Members

Montreal, Canada—Three African nations have become members of the International Civil Aviation Organization bringing membership to a total of 83. The three nations are: Republic of Mali; Republic of Senegal; and Federation of Nigeria.

CHECK-OUT MISSILE CONTROLS

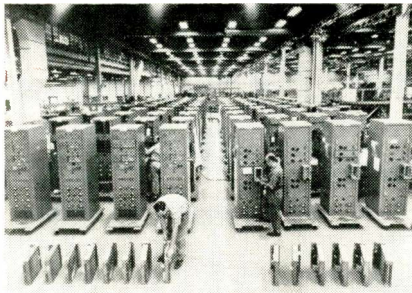

New electronic trouble-spotting equipment will cut from four days to less than one hour typical check-out tests of bomber and missile radar-control systems. Dynamics Corp. of America Subsidiary, Reeves Instrument Corp., built the system. It will be installed in Japan, Germany, and east and west coasts of U. S.

Form British Subsidiary

London—Gulton Industries, Inc., is forming a British subsidiary, Gulton Industries (Britain) Ltd. Production is expected to begin in about 3 months.

The company manufactures highly sophisticated components, instruments, equipment and advanced electronic systems for space, military, industrial, medical, and consumer uses.

Appoint New Representatives

Los Angeles—Gertsch Products, Inc. has moved to strengthen their position in Western Europe, appointing sales representatives in 7 countries: Sweden, Denmark, Norway, West Germany, France, Italy, Switzerland, and England.

The company is also negotiating a licensing agreement with two British firms for the production of Gertsch equipment in England. These companies would serve the United Kingdom—Commonwealth market.

European Semiconductor Market Complex But Rising—Riley

New York—"Europe's semiconductor industry is so different from that of the U.S. that blanket comparisons are meaningless," says Dr. Dennis P. Riley, President, Intertechnical Consultants, Inc., Geneva. He says that, "it would be a grave error to assume that Europe is simply lagging behind the U.S. in terms of time in the development and use of semiconductor devices. The position is qualitatively different and is likely to remain so for at least the next five years."

His firm recently completed a survey of the European semiconductor industry. They found that the entertainment industry, especially transistorized portable radios, dominates the demand for transistors and diodes in Europe. Japanese imports are severely restricted by tariffs and quotas. "Demand for military types of semiconductors is small," he said, but he predicted that Europe would continue to look to the U.S. for this type in the foreseeable future.

More than 85% of Europe's semiconductor production is in the U.K., Germany, and France. Dr. Riley predicted that mergers and acquisitions would result in a relatively small number of large European semiconductor producers.

The European market for semiconductor devices is rapidly expanding, but he warned American investors to be extremely careful in assessing trends since the market is a complex one and each country requires separate consideration.

West Germany Orders American Transponders

Munich—The West German Government, through Siemens and Halske A.G. (Munich) is ordering AN/APX-46(V) IPF airborne transponders from Hazeltine Corp., Little Neck, N. Y.

The transponder has been selected by West Germany for its Lockheed F-104 all-weather fighter-bomber. A transponder automatically responds to electronic interrogation for identification purposes.

Hazeltine will furnish technical assistance and manufacturing know-how to Siemens and Halske. Approved by the U. S. Dept. of State, the program will be paid for in dollars in line with the government's policy of reversing the dollar and gold flow abroad.

"International News"

(Continued on page 34)

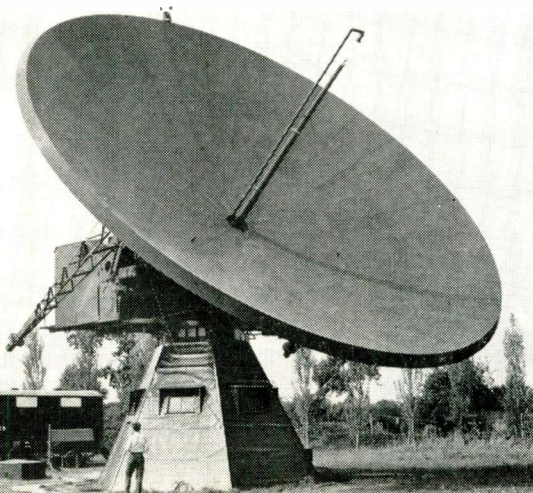

PROBE MOON'S SURFACE

This 45-ft radio telescope was used by the Royal Radar Establishment, Malvern, Eng., to check moon's surface as a radar reflector. They found vertical irregularities which were greater than a wavelength and a horizontal scale which is considerably larger.

Waveguide Switches

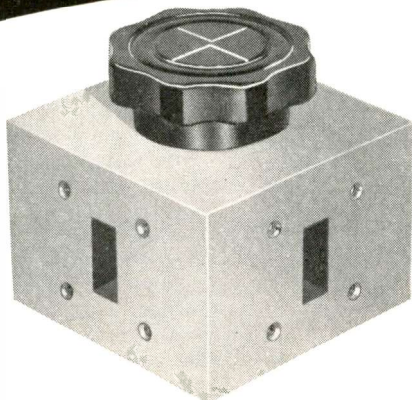

Waveline precision Waveguide Switches are available in seven waveguide sizes to cover the frequency range of 3.95 to 40.0 KMC. These manually operated devices have been designed for applications in the laboratory or for microwave systems to make alternate connections between two waveguide inputs and two waveguide outputs.

Excellent electrical characteristics are achieved by unique precision and assembly techniques which Waveline has developed to provide the highest quality of microwave instruments. Full waveguide range operation is obtained with a VSWR of 1.10 maximum and an isolation greater than 60 db.

The switches are normally supplied with rotation in the narrow wall plane (circular bend of the rotor in the "E" plane) and are manually operated by means of a knob. Also available are "H" plane versions which are designated by suffix letter H.

Waveline Model No.	Frequency Range, KMC	Waveguide Type
378-E	3.95 to 5.85	RG-95/U
478-E	5.85 to 8.20	RG-106/U
578-E	7.05 to 10.00	RG-68/U
678-E	8.20 to 12.40	RG-67/U
778-E	12.40 to 18.00	RG-107/U (AL)
878-E	18.00 to 26.50	RG-66/U (AL)
1078-E	26.50 to 40.00	RG-96/U (AL)

WAVELINE INC.

CALDWELL, NEW JERSEY

Phone: CApital 6-9100

TWX Caldwell, N. J. 703

FOR JAPANESE WIND TUNNEL

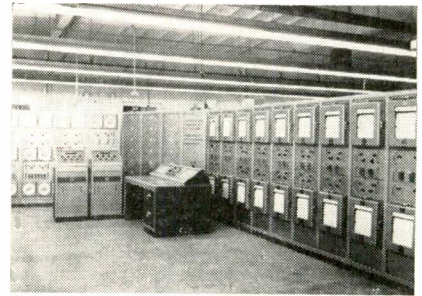

Digital data handling system built by Datex Corp., Monrovia, Calif., will record data from a transonic wind tunnel at the Aeronautic Technology Laboratory, Tokyo, Japan. System can handle 220 pressure data and 20 force data variables. Control consoles are separate.

Supply Instrumentation For France's Sahara Missile Range

Paris—Compagnie des Compteurs has awarded a \$1,365,000 contract to Cubic Corp., San Diego, Calif. for distance-measuring equipment, angle-measuring equipment and associated data-handling equipment and plotting boards.

The equipment is for advanced instrumentation of the Sahara Missile Range (Colomb-Bechar) in North and Central Africa.

The equipment is an advanced version of the AME-DME aircraft/mis-sile/satellite tracking systems now used on several missile ranges.

Compagnie des Compteurs will also manufacture the equipment in France under a licensing agreement with Cubic's subsidiary in Luxembourg, Cubic S.A.

Battery Imports An "Issue"

New York—The National Electrical Manufacturers Association has issued a statement on the problem of battery imports into this country.

The Association warns that "if the trend continues, the U.S. industry may no longer be in a position to supply military and civilian defense needs in the event of a national emergency."

A spokesman for the Association explained the rapid increase in imports as a result of extremely low labor costs, marginal standards of living in those countries and nominal import duties.

The immediate concern is the sharply rising imports from Japan, but the problem involves a number of postwar industrially rehabilitated nations.

Sign Battery Agreement

Elmsford, N. Y.—Sonotone Corp. has signed a licensing agreement with Japan's Furukawa Battery Co., Ltd.

Furukawa will manufacture, sell and develop Sonotone's sintered-plate, nickel-cadmium batteries in certain Far Eastern territories, including Japan.

For HEAVY DUTY WORK!
Severest Electrical Services



P-506-CE—Plug with Cap



S-506-DB
Socket with deep Bracket

JONES PLUGS & SOCKETS

500 SERIES
Proven Quality!

For 5,000 Volts, 25 Amperes
per Contact Alterable by
circuit Characteristics.

Socket contacts of phosphor bronze, knife-switch type, cadmium plated. Plug contacts hard brass, cadmium plated. Made in 2, 4, 6, 8, 10 and 12 contacts. Plugs and sockets polarized. Long-leakage path from terminal, and terminal to ground. Caps and brackets, steel parkerized (rust proofed). Plug and socket blocks interchangeable in caps and brackets. Terminal connections most accessible. Cap insulated with canvas bakelite.

Write for Jones BULLETIN 22 for full details on line.



Jones

HOWARD B. JONES DIVISION
CINCH MANUFACTURING COMPANY
CHICAGO 24, ILLINOIS
DIVISION OF UNITED-CARR FASTENER CORP.

Circle 18 on Inquiry Card

NEW
HYDRAZINE
ACTIVATED

CORE
SOLDER

FLOWS AT IDEAL RATE, LEAVES NO SOLDERING RESIDUES

Non-corrosive HYDRAZINE FLUX,* used industry-wide in liquid form, has now been incorporated into core solder. This fast, efficient flux vaporizes completely at soldering temperatures. It leaves no residue which would support fungus growth. Will not corrode.

In H-32 core solder for the first time, HYDRAZINE FLUX offers more advantages than ever. When flux is normally applied, far more than is actually needed is used. Now, the exact ratio of flux to solder provides for proper wetting. Thereafter the flux decomposes and is eliminated. Cleaning and production time are saved.

TEST HYDRAZINE FLUX AND CORE SOLDER in your own plant. Write for samples of either H-Series Fluxes or H-32 core-solder form and technical literature.

*U.S. Patent No. 2,612,459

Available only from Fairmount and its sales agents

Fairmount

CHEMICAL CO., INC.

136 Liberty St., N. Y. 6, N. Y.

Circle 19 on Inquiry Card

ELECTRONIC INDUSTRIES • February 1961

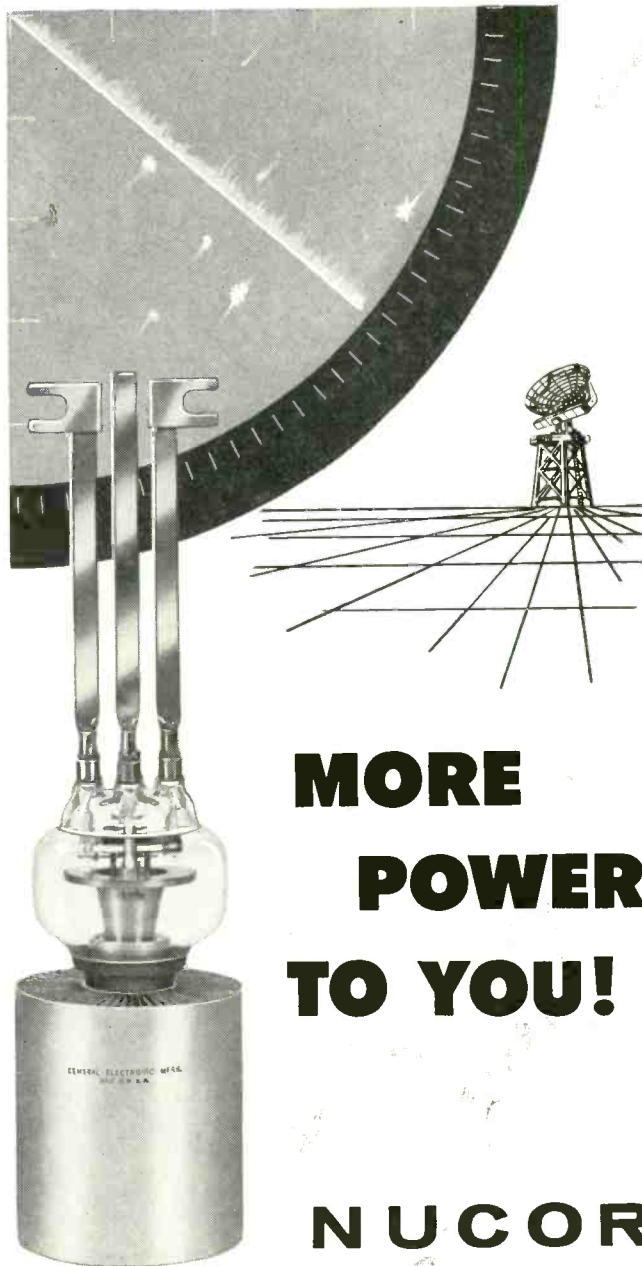

MORE POWER TO YOU!

NUCOR XD-45

Today's radars demand more pulse power in less space. Nucor's answer is the 7545/XD-45, specifically designed for switch tube service. Though compact in size, this proprietary tube will switch 3.4 megawatts at 25 Kv hold-off anode voltage with pulses up to 25 u seconds, 200 amperes peak. The XD-45 is air cooled—6 Kw anode dissipation, and is available from stock.

When your design calls for pulse power—
see Nucor first!



NUCLEAR CORPORATION OF AMERICA

CENTRAL ELECTRONIC MANUFACTURERS DIVISION

DENVILLE, NEW JERSEY

Circle 36 on Inquiry Card

Gertsch Freq Meter

MEASURES AND GENERATES: 20 mc to 1000 mc

ACCURACY: 0.0001%, exceeding FCC requirements 5 times

MODULATION: AM, 30% at 1000 cps; FM
1 kc at 30 mc, 5 kc at 150 mc,
or 15 kc at 450 mc max.

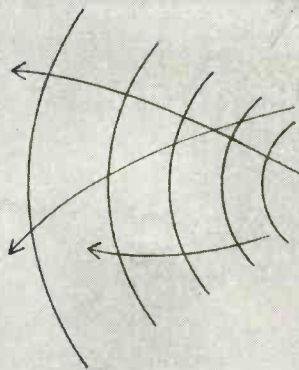

This portable instrument in one complete package enables you to measure both frequency and frequency deviations in the maintenance of mobile communications systems.

As optional equipment the FM-7 Frequency Meter can be combined with the new DM-3 Deviation Meter as illustrated. The DM-3 is a dual-range deviation meter with 15 kc. and 7.5 kc full scales.

By combining the FM-7 and the DM-3 you get a single instrument capable of measuring and generating carrier frequencies *plus* reading peak modulation deviation.

Write for complete literature.

Gertsch

GERTSCH PRODUCTS, Inc.

3211 South La Cienega Boulevard, Los Angeles 16, California/Upton 0-2761 · Vermont 9-2201

Electronic Switching System Opened by Bell

Bell Telephone Laboratories, Whippany, N. J., has shown a new Electronic Central Office Switching System. The system is being tried out in Morris, Illinois.

Costing \$25 million, it supplants plug, switch and relay-type systems. New types of miniature components and assemblies permit a high degree of mechanization. Of more than 200,000 electronic parts in the Exchange, over 118,000 are semiconductor devices. Over 12,000 transistors and 105,000 diodes handle logical functions. The switching network uses some 23,000 neon-filled tubes. Printed circuit boards, photomultiplier tubes, photographic memory plates and a cathode ray tube are also used in the new system.

The Electronic Central Office is composed of three parts. First, the Concentrator, switching network and trunk circuits, providing the talking connections between the telephone lines; next, the controls, the diode and transistor logic and the two memories, the barrier grid storage tubes and the flying spot storage. The third part embraces the scanner and selector, connecting the controls to the line and trunks.

The scanner, a multiposition electronic switch, allows the controls to look at a particular line, 10 times per second, day and night. When someone dials the scanner speeds its action to 100 times a second, so as not to miss any of the dial pulses. The switching network and associated concentrator provide the voice paths.

Three kinds of equipment make up the electronic controls: Logic—the central control—consists of four cabinets containing nearly 3000 transistors and 20,000 diodes mounted on 3400 plug-in circuit packages.

Temporary memory—barrier grid store—used for temporary records, a cathode ray device in which an electron beam is used to write and read dots of charge on an insulating surface—mica. Four such memories are used, two working and two standing. Each store remembers 16,384 yes or no's. Read-write cycle takes 2.5 microseconds.

Semi-permanent memory—flying spot store—a high-speed, random access, large capacity, photographic memory used to store program and line transmission information.

Bourns Trimpot® Puts the Proof in Humidity-Proof

Plunging a potentiometer into near-boiling water is just one of the ways Bourns puts the proof in humidity-proof. Every Trimpot unit made takes this 60-second bath with the water simmering at 90°C. Air expanded by the heat creates four pounds of pressure inside the potentiometer—enough to cause bubbles—if it leaks. Only if the unit is completely leak-free does it pass the test.

Bourns humidity proofing starts at the beginning—with original design and selection of materials. The plastic chosen for Trimpot cases, for example, displays the unusual properties of high insulation resistance and extremely low moisture absorption.

Further protection against humidity results from manufacturing procedures, such as internal potting of the resistance element and sub-components. Finally, Bourns samples all production for compliance to MIL-STD-202A, Method 106 as a routine part of a Reliability Assurance Program. As a result, Trimpot does more than “resist” moisture; it keeps moisture out.

For more information about the industry's largest selection of humidity-proof adjustment potentiometers—wirewound and carbon in a variety of sizes, power ratings, operating temperatures, etc.—write for new Trimpot summary brochure and list of stocking distributors.



BOURNS

BOURNS, INC., TRIMPOT DIVISION
8135 MAGNOLIA AVE., RIVERSIDE, CALIF.
PLANTS: RIVERSIDE, CALIF. AND AMES, IOWA

Exclusive manufacturers of Trimpot®, Trimit®, and E-Z-Trim®. Pioneers in transducers for position, pressure and acceleration.

JENNINGS VACUUM CAPACITORS

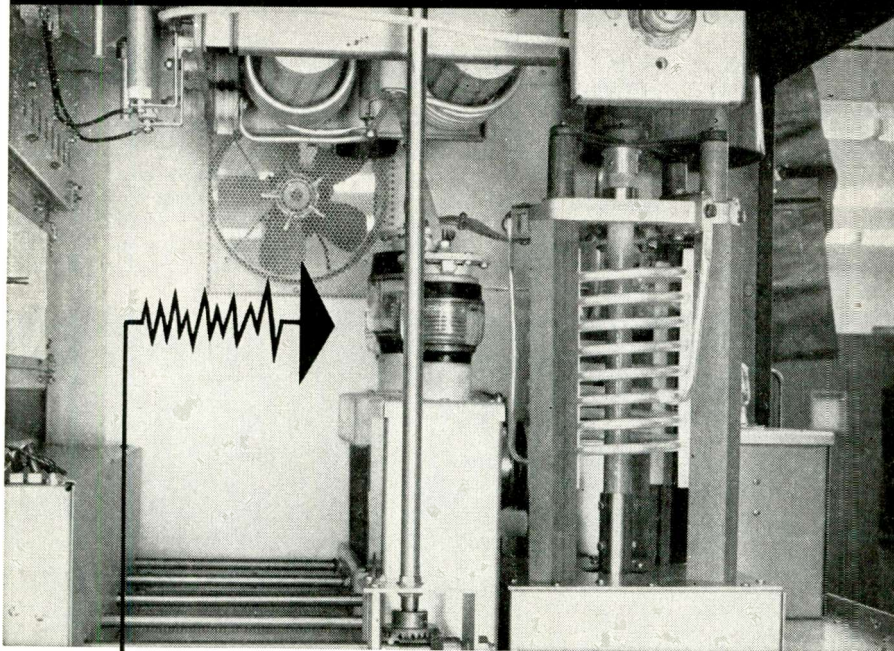

... speaking of capacitors—
**NOTICE HOW LITTLE SPACE
 HIGH VOLTAGE VACUUM
 CAPACITORS OCCUPY!**

Which is one of the reasons why Technical Materiel Corp. engineers are using 8 different types of vacuum capacitors in this new GPT-10K 10,000 watt SSB transmitter with complete band switching through its frequency range of 2 to 28 megacycles. Inductive losses are very low because the vacuum dielectric and concentric construction permits a maximum amount of capacitance at high voltage to be packed into an extremely small physical space. Vacuum capacitors also contribute to the superior performance of the transmitter through their extremely high ratio of capacitance change that makes possible a wide frequency range. Other advantages include all copper construction for high current ratings, and plates safely protected against contamination throughout their life by the vacuum seal.

Vacuum capacitors are useful in all sections of high powered transmitters, dielectric heating equipment, antenna phasing equipment and electronic equipment from cyclotrons to electron microscopes. Jennings manufactures over 300 types of vacuum capacitors with voltage ratings of 5 kv to 120 kv, and current ratings up to 500 amps rms. Further information on Jennings' complete line is available on request.

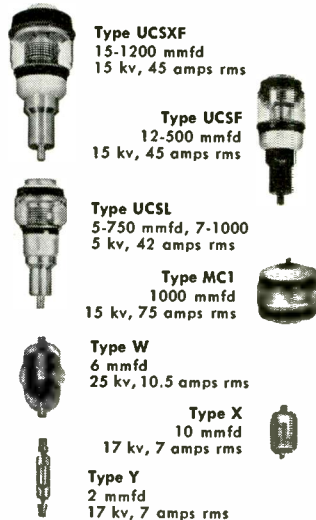
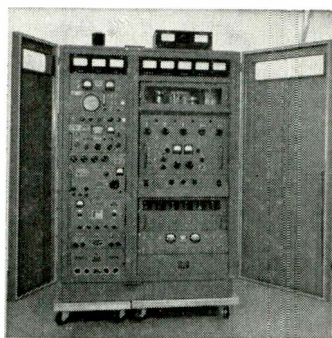

Type UCSXF
 15-1200 mmfd
 15 kv, 45 amps rms

Type UCSF
 12-500 mmfd
 15 kv, 45 amps rms

Type UCSL
 5-750 mmfd, 7-1000
 5 kv, 42 amps rms

Type MC1
 1000 mmfd
 15 kv, 75 amps rms

Type W
 6 mmfd
 25 kv, 10.5 amps rms

Type X
 10 mmfd
 17 kv, 7 amps rms

Type Y
 2 mmfd
 17 kv, 7 amps rms

Reliability means Vacuum / Vacuum means

Jennings[®]

JENNINGS RADIO MFG. CORP., 970 McLAUGHLIN AVE., SAN JOSE 8, CALIF., PHONE CYpress 2-4025

Tele-Tips

DID AN ATOM BOMB devised by prehistoric space travellers demolish the cities of Sodom and Gomorrah? A noted Russian physicist has won himself a good deal of attention by advancing the suggestion. But the Soviet Academy of Sciences slapped his hand last month, pointing out that while the idea cannot be flatly rejected there is not a single shred of proof that Earth has ever been visited by people from outer space.

MARS NETWORK—Military Affiliate Radio System—has just completed an even dozen years of service. The joint Army-Air Force organization of licensed amateur radio operators has a membership of about 15,000, more than 70% civilians.

ECHO I, the balloon satellite, is large—almost 100 ft. in diameter—but not nearly as big as can be made. The G. T. Schjeldahl Company, Northfield, Minn., designers and builders of ECHO, feel that balloons ten times that size—1,000 ft. in diameter—are possible. They are also working on techniques for making the inflatable space structures more rigid once they are in orbit.

SUPPLIERS TO JET airplane manufacturers must blink their eyes at requests like this: talcum powder, diapers, bicarbonate of soda and castile soap. But these orders are an every day occurrence at Republic Aviation on Long Island. The talcum and soap are used as lubricants in installing rubber and plastic items like fuel cells; the diapers are for polishing canopies and the bicarb is used in the paint shop as a cleaning aid.

ELECTROMAGNETIC WAVES caused by lightning discharges (sferics) are being investigated by National Bureau of Standards. At Brighton, Colo., NBS has installed an "Ephi" system consisting of three 125 ft. vertical antennas spaced about four miles

(Continued on page 40)

Inland d-c torque motors

provide direct drive servo positioning . . .

NO GEARS, NO BACKLASH

Complete range . . . 0.1 to 3,000 pound-feet

Inland offers a complete line of compact d-c torquers for airborne, shipboard or ground service stabilization and tracking systems. Increased system accuracy has been achieved by mounting the torquers directly on the driven member. This completely eliminates gear backlash and other problems normally associated with gear trains, reduces substantially over-all friction error, and improves the over-all constant of the system. In addition, Inland's d-c torquers combine the compact pancake shape with very high peak torque, low input power, and high angular resolution.

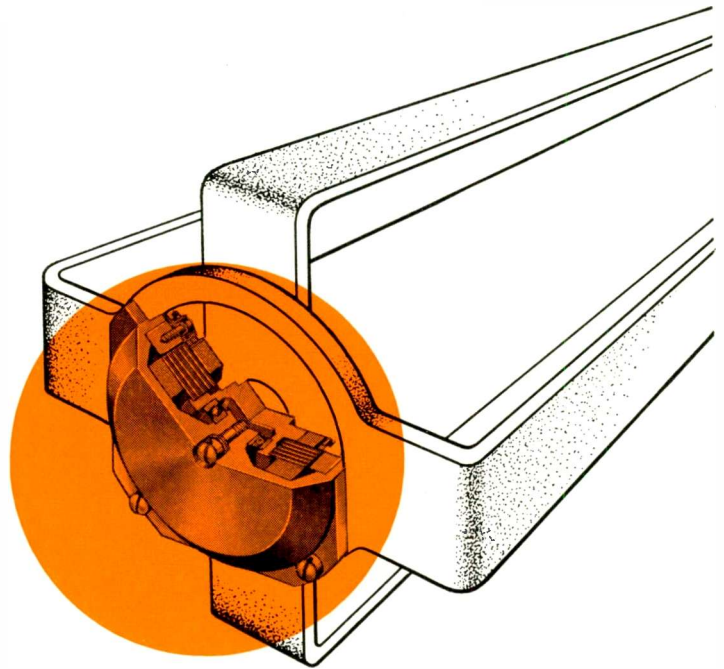

Exclusive commutator and brush rigging design

Inland has achieved this compact pancake shape while maintaining the low-power input to high-torque output ratio of a d-c torquer.

INLAND AMPLIFIERS—Inland makes a wide line of control amplifiers for systems duty with Inland torquers. Write for technical details.

COMPARE THESE RATINGS WITH A TYPICAL SERVO MOTOR-GEAR TRAIN COMBINATION

	T-2136-A	T-2136-B	T-2136-D
Peak torque, oz. in.	35	35	35
Volts at peak torque, stalled at 25°C	26.0	20.6	33.5
Amps at peak torque	1.6	2.0	1.3
Total friction, oz. in.	0.8	0.8	0.8
Rotor Inertia, oz. in. sec ²	.007	.007	.007
Weight, oz.	9	9	9
Dimensions (inches):			
O.D.	2.81	2.81	2.81
I.D.	1.00	1.00	1.00
Thickness	.63	.63	.63

For complete data on these or other Inland d-c pancake torquers, address Dept. 8-2, Inland Motor Corporation of Virginia, Northampton, Massachusetts.



INLAND MOTOR CORPORATION OF VIRGINIA
A SUBSIDIARY OF KOLLMORGEN CORPORATION
NORTHAMPTON, MASS.

Tele-Tips

(Continued from page 38)

apart and forming the vertices of an equilateral triangle. The em waves created by lightning will arrive at the antennas at different times depending on their distance from where the bolt hit. The time intervals will all allow NBS to "fix" the location of the storm.

MINIATURIZATION seems to be approaching the ridiculous when you come across an item like this: At the instrument jewel bearing plant in Rolla, N. D., which Bulova operates for the government, the total annual output is about 2,000,000 bearings. And this 2,000,000 bearings just about fills one milk bottle.

"AN ELECTRONIC DEMOCRACY" with communications networks that would allow all American citizens to vote directly upon bills before Congress, is foreseen by Stahl W. Edmunds, manager of market analysis at Hughes Aircraft Co. Individual citizens would cast their ballots through a home voting transmitter after witnessing the floor debates on TV. It may even be possible, says Edmunds, for citizens to participate in the debate, through 2-way TV.

ALMOST 9 of every 10 U. S. households have television sets. 11% have two sets or more.

JUST WHEN and how we are going to communicate with living creatures on other planets is a question that is getting a lot of attention. But Prof. Fred T. Haddock of the University of Michigan feels that it is unlikely that we will receive radio signals from outer space in the immediate future; that great deal of improvement is necessary in radio receivers. At the moment, he points out, the best radio receivers are only roughly comparable to the naked eye and the ability to see fine detail—we can see about 5000 stars at night and that many radio stars can be detected.



here is your answer!

Puzzled about how to pack reliability and producibility into a high density module? Take a clue from Engineered Electronics Co., Litton Industries, Sippican Corp., and Space Technology Labs (l to r above). Weld it! These companies and many other leaders have already discovered that Weldmatic precision electronic welding equipment makes component packaging a pleasure. Why don't you see for yourself?

WELDMATIC DIVISION / UNITEK
950 Royal Oaks Drive, Monrovia, California

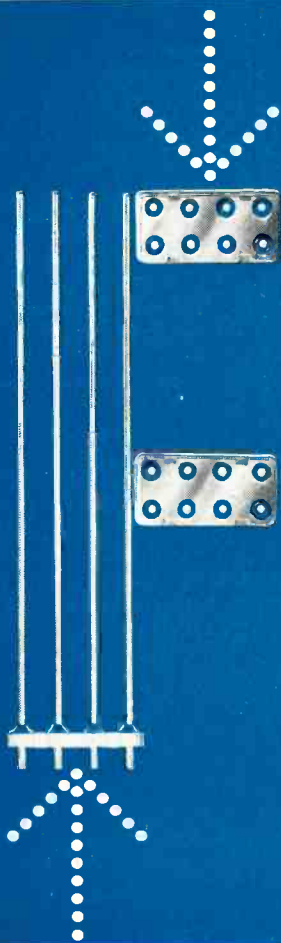

NEW FROM

FUSITE

*A GLASS THAT MAKES
MICRO-MINIATURE RELAY
HEADER DO TRICKS*

From the smelting furnace at Fusite has come a glass so ideal for use with 52% nickel alloy pins and mild steel body it obsoletes all previous compression type seals.

Designated TR-Glass it grips the pins so tightly no amount of bending or twisting will cause the terminal to leak. Heat shock of 1000°F in 20 seconds is child's play for the compatible combination of materials in this new relay header.

The favorable balance of expansion between TR-Glass and the two dissimilar metals of pins and body assure performance well in excess of Mil specs.

Available in electrode styles of hook, plug-in and extended lead. Samples on request. Write Fusite Corporation, Department G-1.



Fusite Corporation, Cincinnati, O.
Woodford Mfg. Co., Versailles, Ky.
Fusite N. V., Königweg 16, Almelo, Holland
Fusite GmbH, Dieselstrasse 5 Karlsruhe, W. Germany

THE FUSITE CORPORATION
6000 FERNVIEW AVENUE,
CINCINNATI 13, OHIO

Letters

to the
Editor

Whose Patent?

On page 14 of your September issue there is a short comment headed "G.E. granted patents on man-made diamonds." I am not interested in diamonds, but I would like to make a comment. According to the patent laws of this country, patents can be granted only to individuals and not to corporations. This is as it should be since only individuals can reason and have inventive ideas. Thus although patents may be assigned to a corporation, they can not be granted to it as you stated. This method of reporting in addition to being incorrect is also somewhat unfair to the inventor who really developed the process.

Henry F. Ivey
Section Manager
Phosphor Research

Westinghouse Electric Corporation
Lamp Division
Research Department
Bloomfield, New Jersey

Ed: Mr. Ivey's observation is, of course, correct—and worth remembering.

"Under Missiles"

Editor, ELECTRONIC INDUSTRIES:

While doing a little research in your excellent 1960-61 Directory and All-Reference Issue I came across a small error under the "Key Guided Missile Contractors" list on page 148. Under the heading "Company," Northrup Corp., NORAI Div.; this should read Northrup Corp., NOR-AIR Div.

Please accept my thanks for the subscription to ELECTRONIC INDUSTRIES. I believe this is one of the finest publications in its field.

A. J. Eldridge

Technical Representative
Northrup Corp., Norair Div.
First Security Bldg.
Ogden, Utah

"Cancelling Sine Waves"

Editor, ELECTRONIC INDUSTRIES:

The November issue contains a "page from an Engineer's notebook, #58—Cancellation of Sine Waves," by J. J. Davidson. (P. 165.) He considers that when,

$$e_1 = \sin \omega t$$

$$e_2 = \sin (\omega t \pm \alpha)$$

$$e_r = e_1 - e_2 \doteq \pm (\sin \alpha) \cos \omega t$$

for small α .

An exact solution is readily obtainable using elementary trigonometry.

(Continued on page 50)

New!

LENZ

"HYANODE"

HIGH VOLTAGE LEAD WIRE

UL INSPECTED

This new, UL Inspected and Labeled Wire is especially designed for use as Anode Connectors, Fly-Back Transformer Leads and similar applications in TV Receivers, and other electronic circuits carrying high voltages.

Code HYANODE combines high dielectric strength with maximum flexibility and minimum outside diameter. It is available with No. 22 Ga. through No. 18 Ga. Stranded Tinned Copper Conductors. Outer jackets of extruded plastic compounds are rated at 80°C, 90°C or 105°C. Standard Color is Red—other colors available.

OUTSIDE DIAMETERS

Gauge	Max. Fin. O.D.
#22	0.167"
#20	0.174"
#18	0.183"

Quotations based on your quantity requirements
furnished promptly. Samples available on request.



WIRES

and

CABLES

LENZ ELECTRIC MANUFACTURING CO.

1751 No. Western Ave.

Chicago 47, Ill.

In Business Since 1904

General Instrument Semiconductor... Design Breakthrough

NEW **G** 2N1678 "DYNAMIC DRIFT"

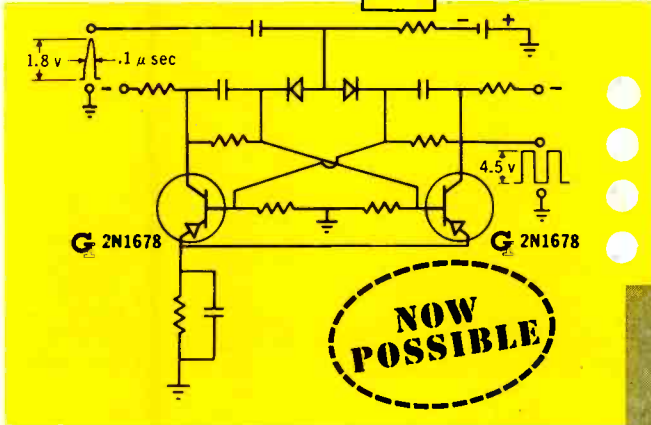

- High Voltage
- High Speed
- Saturated Circuitry
- At Low Cost

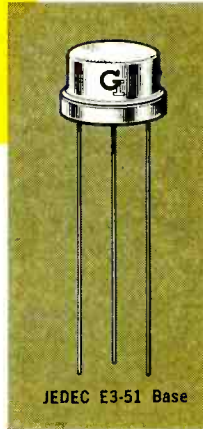

2N1678 PNP Germanium "Dynamic Drift"				
Parameter	Conditions	Min.	Typ.	Max.
T_c		-65°C		+85°C
P_c	$T_c = 25^\circ\text{C}$			120 mw
V_{CES}	$I_c = 100 \mu\text{a}$	60 v		
V_{CE0}	$I_{CBO} = 25 \mu\text{a}$	60 v		
V_{EBO}	$I_{EBO} = 100 \mu\text{a}$	4 v		
h_{FE}	$I_c = 20 \text{ ma}; V_{CE} = 0.25 \text{ v}$	25	40	
I_{CBO}	$V_{CE} = 10 \text{ v}$			5 μa
V_{BE}	$I_c = 20 \text{ ma}; V_{CE} = 0.25 \text{ v}$			0.6 v
f_{trf}	$I_c = 1 \text{ ma}; V_{CE} = 5 \text{ v}$	25 Mc	35 Mc	
f_{thf}	$I_c = 1 \text{ ma}; V_{CE} = 10 \text{ v}$		50 Mc	
h_{fr}	$I_c = 1 \text{ ma}; V_{CE} = 5 \text{ v}; f = 1 \text{ kc}$		30 ?	
h_{br}	$V_{CE} = 5 \text{ v}; I_c = 1 \text{ ma}; f = 1 \text{ kc}$		0.5 $\mu\text{ mho}$	2 $\mu\text{ mho}$
C_{ob}	$V_{CE} = 5 \text{ v}; I_c = 1 \text{ ma}; f = 5 \text{ Mc}$		3.5 pf	5 pf
$t_r + t_f$	$I_c = 20 \text{ ma}; I_{B1} = I_{B2}$		0.4 $\mu\text{ sec}$	
$t_r + t_f$	$I_c = 1 \text{ ma}; R_L = 1 \text{ K}$		0.4 $\mu\text{ sec}$	

General Instrument proudly presents the 2N1678 "Dynamic Drift"... ideally suited for high speed, high voltage saturated circuit applications. The 1 Mc bistable multivibrator, above, is only one example of the multitude of applications for this attractively-priced transistor family.

Life test data proves reliability of the new General Instrument 2N1678 "Dynamic Drift". Close quality control guarantees extremely high electrical uniformity, shipment to shipment.

FULL LINE OF QUALITY **G** COMPUTER SEMICONDUCTORS

General Instrument is your major source for high quality computer semiconductors... transistors, as well as companion diodes, rectifiers and logic encapsulations for every type of circuit application. The transistor families shown below indicate the broad range of superior quality units offered by General Instrument.

Write General Instrument for complete engineering and life test data, design curves, and typical circuitry which takes advantage of the unique combination of characteristics offered by the new **G** 2N1678. Data is available, of course, on our full line of computer semiconductor. Our engineers will gladly discuss your specific circuit requirements.

All speeds shown have been attained with conventional saturated circuitry. Total bar length represents rate (period) using speed-up capacitors; broken bar indicates maximum speed without capacitor.

Representative transistors shown are alloyed-junction devices. Types 2N501A, 2N604, and 2N1678 are MADT, Drift, and High-Voltage Drift, respectively.

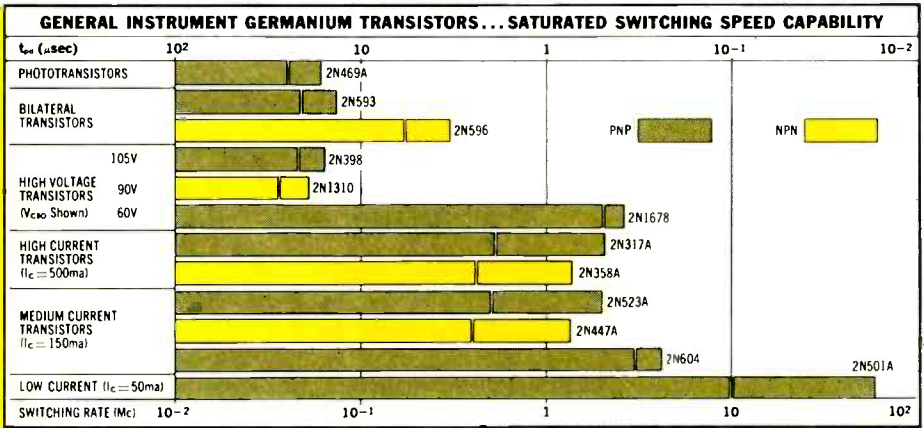

GENERAL INSTRUMENT
GENERAL TRANSISTOR
 TRANSISTORS, DIODES, RECTIFIERS



SEMICONDUCTOR
 DIVISION OF GENERAL INSTRUMENT CORPORATION
 65 Gouverneur Street, Newark 4, New Jersey



IN CANADA: General Instrument—F. W. Sickles of Canada Ltd., P.O. Box 408, 151 S. Weber Street, Waterloo, Ontario, Canada. Sherwood 4-8101.

Micro Edge

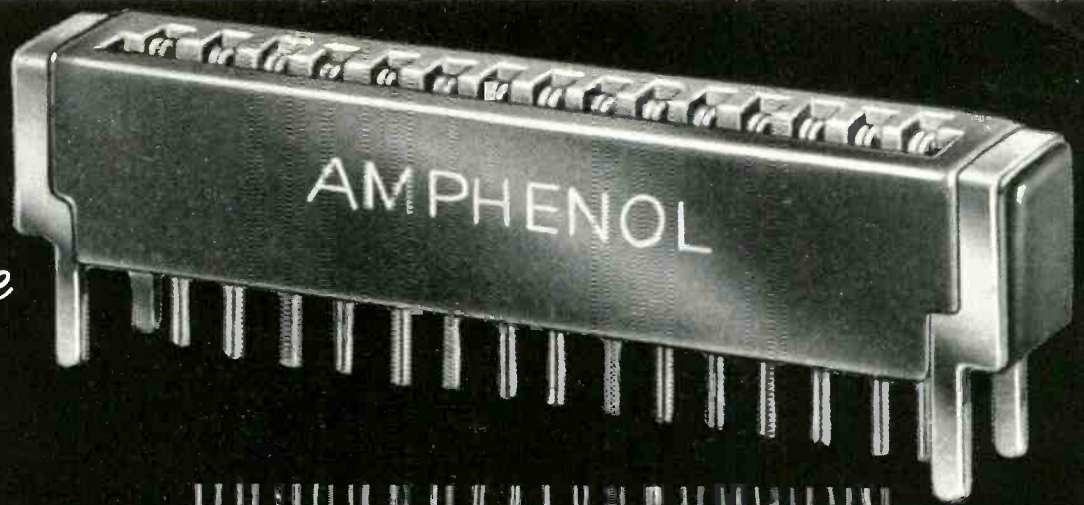

Micro Min

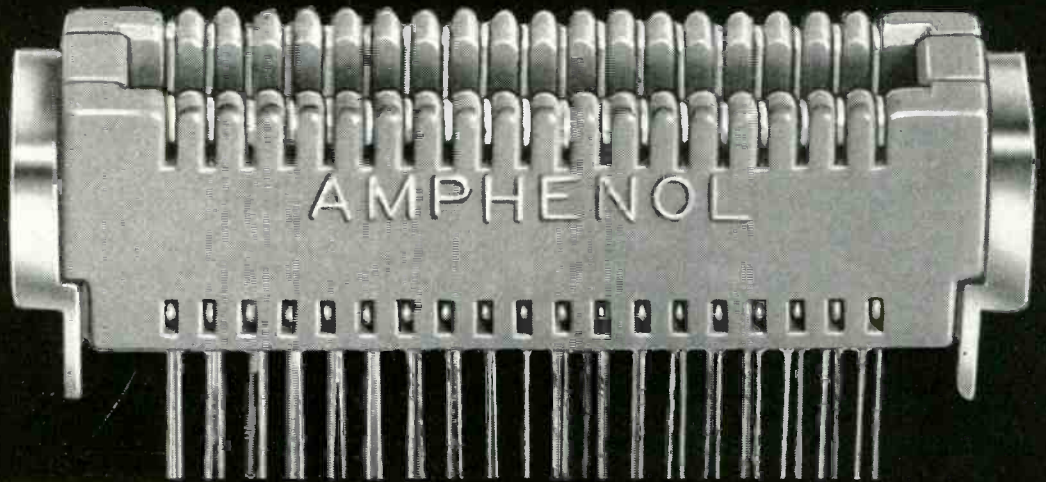
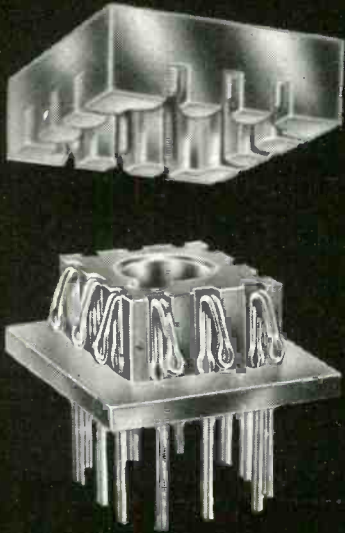
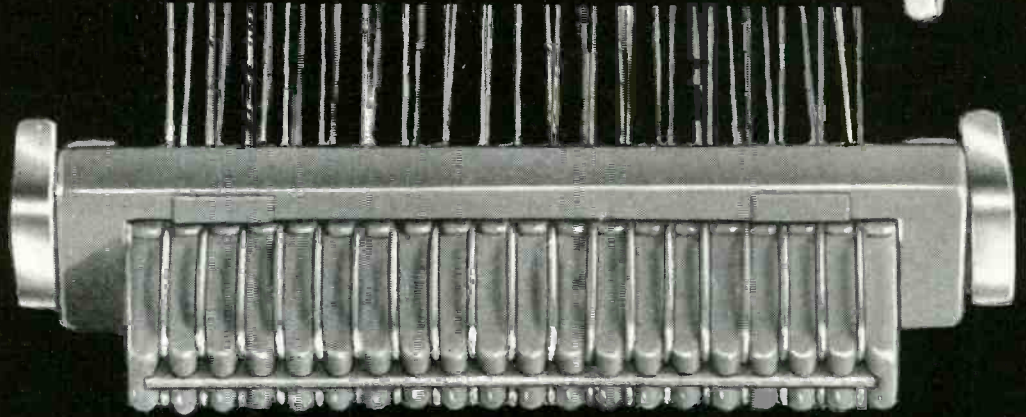

Micro Mod

THESE ARE MICROMINIATURE CONNECTORS—
4 TIMES ACTUAL SIZE!

DIMENSIONS (ACTUAL SIZE)

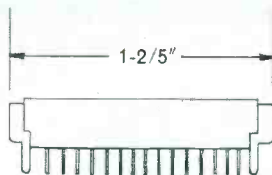

Micro Edge
64 SERIES

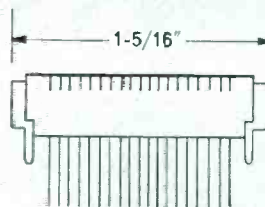

Micro Min
74 SERIES



Micro Mod
96 SERIES

Circle 28 on Inquiry Card

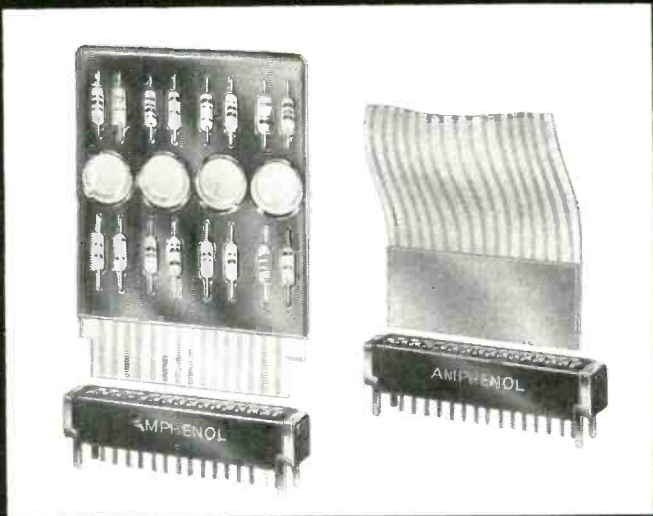

Micro Edge

Receptacle for flexible printed wiring or printed circuit boards. 15 contacts on .075" centers, with 2 lines of interference per circuit.

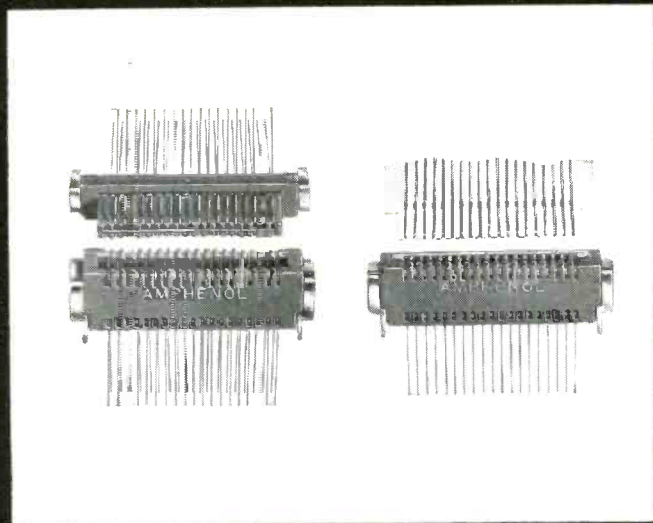

Micro Min

19 contact receptacle with mating components mounting board or 38 contact rack & panel/modular pair. Contacts on .050" centers.

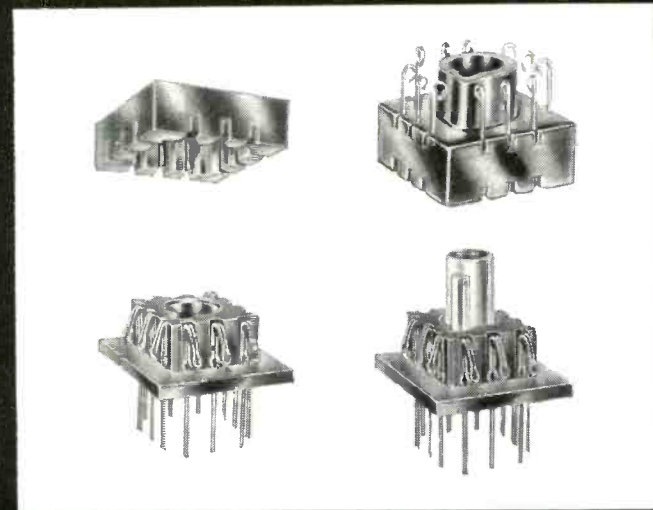

Micro Mod

12 contacts on .075" centers. 2 types available for either modular use or for cable-to-cable, cable-to-chassis or board-to-chassis usage.

AMPHENOL

AMPHENOL CONNECTOR DIVISION

Amphenol-Borg Electronics Corporation

1830 S. 54th AVE., CHICAGO 50, ILLINOIS

Send me full information on Micro Edge, Micro Min and Micro Mod

NAME _____ TITLE _____

COMPANY _____

COMPANY ADDRESS _____ DEPT. _____

CITY _____ ZONE _____ STATE _____

Write for Complete Data!

BUSS FUSES

PLUS
CLIPS—
BLOCKS—
& HOLDERS

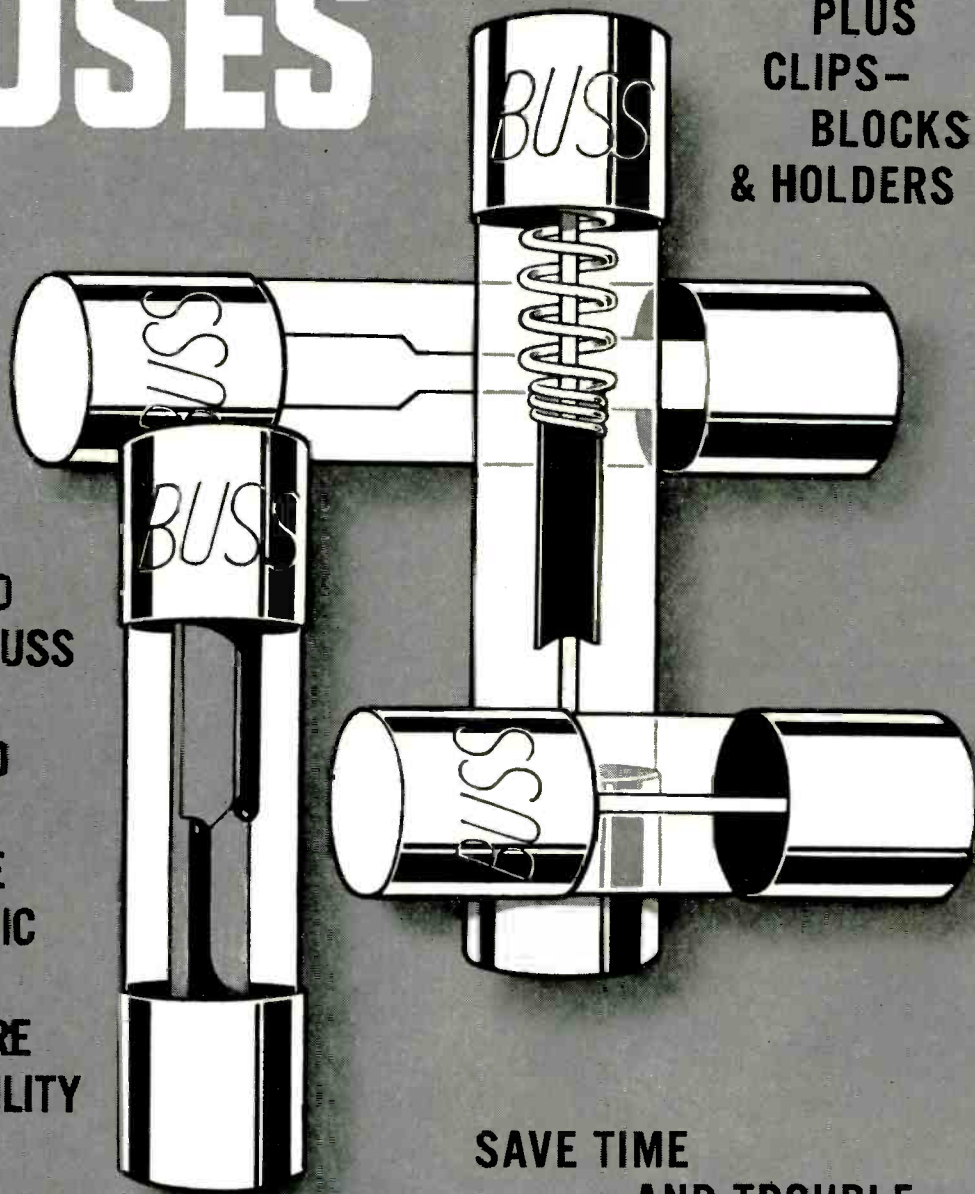

EACH AND
EVERY BUSS
FUSE IS
TESTED
IN A
SENSITIVE
ELECTRONIC
DEVICE
TO ASSURE
DEPENDABILITY

SAVE TIME
AND TROUBLE...

by standardizing on BUSS fuses. There's a right fuse for every need in the complete line. Write for the BUSS bulletin on small dimension fuses (Form SFB) to get full data for your files.

Bussmann Mfg. Division McTraw-Edison Co.
University at Jefferson, St. Louis 7, Mo.

now in
production
at *Reeves*
INSTRUMENT CORPORATION

pancake
resolver



with

10 SECOND

**FUNCTIONAL ACCURACY
AND 2-SECOND REPEATABILITY**

integral bearing permits direct gimbal mounting

The new Reeves 10-second Resolver is the ideal instrument for precision stable platform applications. The units are available with either beryllium or aluminum housings for a wide range of operating temperature applications.

Reeves is especially proud of this latest addition to the comprehensive family of high precision resolvers currently in production and ready for inclusion in your systems packages. Whatever your resolver requirements Reeves has the size and design to meet your specifications. Reeves Resolvers are supplied in the 23, 15, and 11 case sizes. For complete specifications, write for data file 302.

Qualified engineers seeking rewarding opportunities in these advanced fields are invited to get in touch with us.

REEVES INSTRUMENT CORPORATION

A Subsidiary of Dynamics Corporation of America • Roosevelt Field, Garden City, New York



Circle 30 on Inquiry Card

9RV60

for Business or "Treasure"

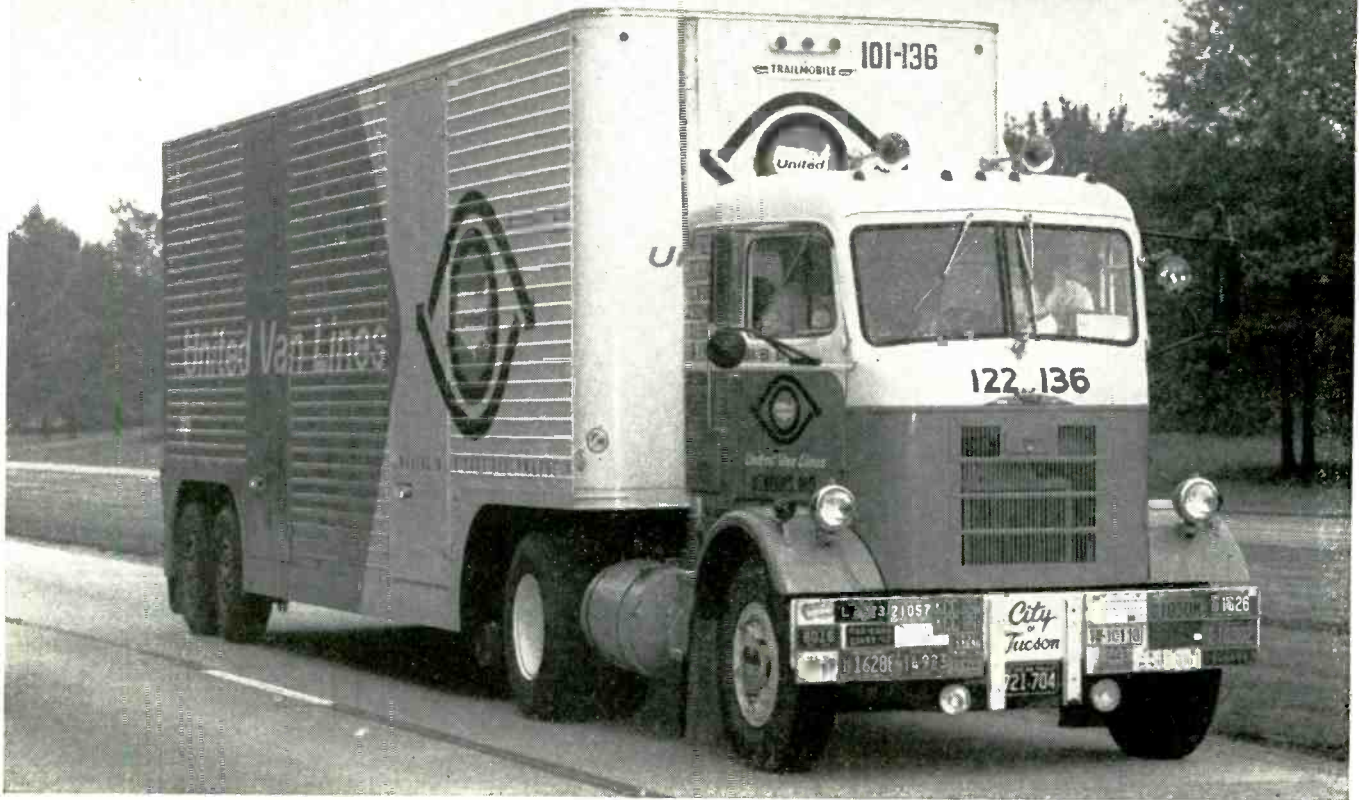

when the occasion calls for MOVING...
call **United Van Lines**

Whether you're moving bulky electronic devices or priceless works of art, you'll find it safer, easier, more convenient via United's modern "Safe-Guard" service.

From nation-wide exhibit tours to "tight-schedule" deliveries of office equipment, United gears its service to your requirements. Spacious, specially-designed vans take tough-to-handle shipments in stride...including the

loading of large units—in one piece—without costly dismantling. And because crating is not needed on most "Safe-Guard" shipments, there's an extra saving in time and expense.

For "Pre-Planned", straight-through service in exclusive Sanitized* vans, call your United Agent today. He's listed under "MOVERS" in the Yellow Pages.

YOUR SHIPMENT LOADS EASIER... TRAVELS SAFER IN A United "SAFE-GUARD" VAN



NEW TANDEM WHEEL ALIGNMENT
Provides valuable inches between wheel boxes... more usable loading area than standard vans.



NEW EXTRA-WIDE SIDE DOORS
A full 72 inches, permit easy, one-piece loading of large items.



NEW REMOVABLE DOCK-HIGH FLOOR
Eliminates hoisting, provides 264 sq. ft. of clear, unobstructed loading space.



NEW LOAD STABILIZERS
Hold your shipment securely in place, prevent shifting or jarring enroute.



FOR YOUR FREE COPY OF *United's* "SAFE-GUARD" MOVING BROCHURE, WRITE:

United Van Lines

INTERNATIONAL HEADQUARTERS, ST. LOUIS 17, MISSOURI

MOVING WITH CARE EVERYWHERE®

* REG. U. S. PAT. OFF.

2 NANOSECOND MICROWAVE SWITCHING with SOLID STATE RELIABILITY

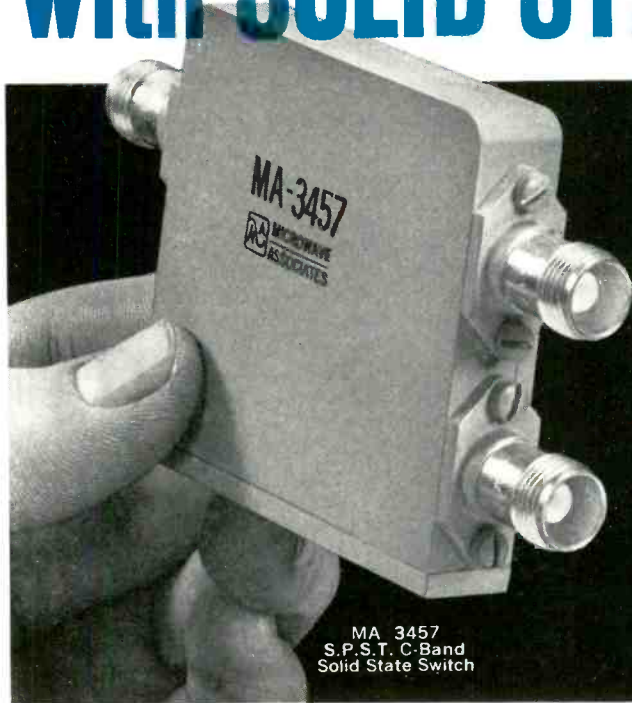

MA 3457
S.P.S.T. C-Band
Solid State Switch

Microwave Associates' new coaxial switches provide:

- ★ Efficient switching across the microwave spectrum
- ★ Solid-state reliability for military applications
- ★ Lightweight (approx. 5 oz.) ruggedized construction
- ★ Low driving power — from 10 to 100 milliwatts
- ★ Power handling capability $\left\{ \begin{array}{l} 4 \text{ watts CW (S.P.S.T. unit)} \\ 150 \text{ watts peak at 0.001 duty cycle} \end{array} \right.$
- ★ Low insertion loss — as low as 0.2 db

Solid-state switches are as good as the semiconductors they incorporate. All units described use the most advanced microwave silicon diodes available, specifically developed for this function by Microwave Associates Semiconductor Division.

LOW POWER LEVEL COAXIAL SWITCHES

Frequency (Mc)	Insertion Loss (Max)	Isolation (Min)	Switching Power
210-240	0.2 db	20 db	10 mw
260-340	0.2 db	18 db	10 mw
400-500	0.3 db	20 db	10 mw
570-630	0.3 db	20 db	10 mw
900-1000	0.3 db	20 db	10 mw
1250-1350	0.5 db	20 db	10 mw

MEDIUM POWER LEVEL COAXIAL SWITCHES

200-1000	1.5 db	22 db	70 mw
1000-2000	1.5 db	20 db	70 mw
2000-4000	2.0 db	16 db	70 mw

LOW POWER LEVEL VOLTAGE VARIABLE ATTENUATORS

Frequency (Mc)	Attenuation Range
260-340	0.2 db-18 db
400-450	0.3 db-20 db
570-630	0.3 db-20 db
1250-1350	0.5 db-20 db

Narrow-band higher frequency units are available with lower loss and increased isolation.

TYPICAL PERFORMANCE BROADBAND MICROWAVE SWITCH SPST

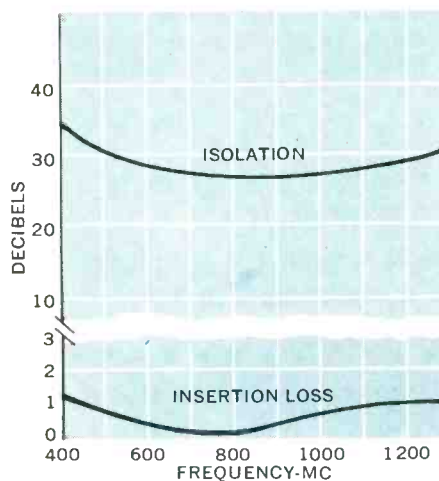

TYPICAL PERFORMANCE VOLTAGE VARIABLE ATTENUATOR (425 Mc ± 25)

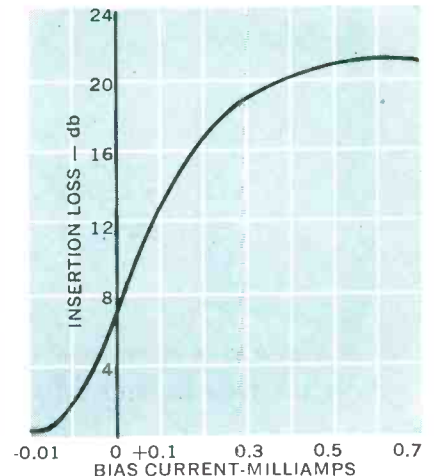

Units for handling higher powers are now in development. Microwave Associates has capabilities for meeting your requirements for single-pole multiple-throw and waveguide switching devices. Our switches invite comparison. We invite your inquiries.

A quotation/data sheet will be sent on request.

MICROWAVE ASSOCIATES, INC. 
ELECTRON TUBE AND DEVICE DIVISION, Burlington, Mass.

Western Union FAX • TWX: Burlington, Mass., 942 • BRowing 2-3000

NOW!
A WHOLE FAMILY OF

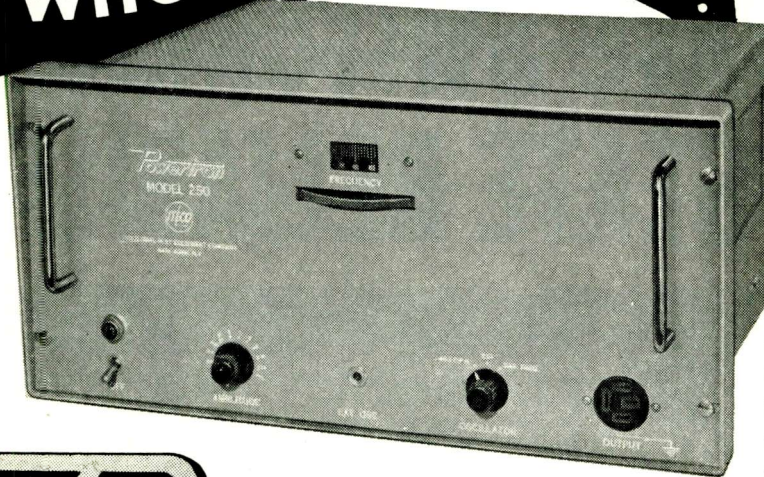

Powertron

ELECTRONIC GENERATORS



Single Phase
With Output
Powers From
3VA-750VA

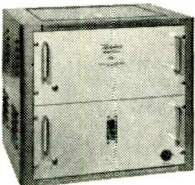

Two-Phase
With Output
Powers From
6VA-1500VA

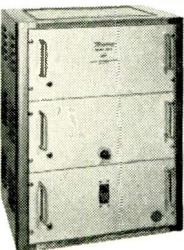

Three-Phase
With Output
Powers From
9VA-2250VA

TYPICAL SPECIFICATIONS

(Model 250 Illustrated Above)

Fixed Frequency.....	400 C.P.S.
Accuracy.....	.25%
Distortion.....	Less than 1%
Regulation.....	Less than 1%
Output Power.....	250VA
Variable Frequency.....	350-450 CPS
External Freq. Range.....	50-4000 CPS
Output Voltage.....	0-125V RMS
Mounting.....	Desk Top or 8 3/4" x 19" Rack Panel.

- HIGHER POWER UNITS TO ORDER
- FREQUENCY ACCURACIES AVAILABLE TO .001%

OFF THE SHELF DELIVERY ON MANY OF THE MODELS LISTED BELOW:

Model 1040 (1Ø, 3VA)	Model 1040-2 (2Ø, 6VA)	Model 1040-3 (3Ø, 9VA)
Model 1040A (1Ø, 8VA)	Model 1040A-2 (2Ø, 8VA)	Model 1040A-3 (3Ø, 24VA)
Model 1500 (1Ø, 20VA)	Model 1500-2 (2Ø, 40VA)	Model 1500-3 (3Ø, 60VA)
Model 150 (1Ø, 160VA)	Model 150-2 (2Ø, 320VA)	Model 150-3 (3Ø, 480VA)
Model 250 (1Ø, 250VA)	Model 250-2 (2Ø, 500VA)	Model 250-3 (3Ø, 750VA)
Model 750 (1Ø, 750VA)	Model 750-2 (2Ø, 1500VA)	Model 750-3 (3Ø, 2250VA)

WRITE FOR DESCRIPTIVE BROCHURES AND PRICES



INDUSTRIAL TEST EQUIPMENT CO.

55 E. 11th ST. • NEW YORK 3 • GR. 3-4684

Visit Booth No. 3613—Radio Engineering Show, N. Y. Coliseum, March 20-23, 1961

Letters

to the
Editor

(Continued from page 42)

$$e_r = \pm 2 \left(\sin \frac{\alpha}{2} \right) \cos \left(\omega t \pm \frac{\alpha}{2} \right).$$

This equation is valid for any α . For small α , the result can be written as:

$$|e_r| \approx \alpha \text{ (in radians).}$$

Arthur Van Gelder
Kearfott Div., G.P.I.

"Company Library"

Editor, ELECTRONIC INDUSTRIES:

I was somewhat tickled to receive this letter from West Germany a day or so ago and I am sending it on to you as I thought you might be interested in knowing what wide distribution ELECTRONIC INDUSTRIES has.

I have, in this connection, sent Mr. Tischke the four reprints he requested. These were furnished from the supply which you were good enough to send me a few days ago.

Harold S. Sharp
Technical Librarian

AC Spark Plug
The Electronics Div. of
General Motors
Milwaukee 1, Wisc.

VIA AIR MAIL
AC Spark Plug Division
General Motors Corp.
MILWAUKEE 1, WISCONSIN
U.S.A.

Sehr geehrte Herren!

In der Zeitschrift "Electronic Industries" No. 11/1960, S. 256-257, stieben wir auf Arbeit mit dem Titel "The Company Library—White Elephant or Work Horse."

Wir interessieren uns sehr für diese Arbeit und bitten Sie, uns 4 Sonderdrucke zur Verfügung zu stellen. Bitte, adressieren Sie Ihre Sendung deutlich an die Technische Bücherei unseres Hauses.

Für Ihre freundlichen Bemühungen danken wir Ihnen im voraus sehr.

*Technische Bücherei
L. Teschke*

Telefunken
G. M. B. H.
Hanover-Linden
Gottinger Chaussee 67

"Compact TW Tubes"

Editor, ELECTRONIC INDUSTRIES:

I received my copy of ELECTRONIC INDUSTRIES this morning which included the article "Compact Traveling Wave Tube Design" by H. Woy-

(Continued on page 52)

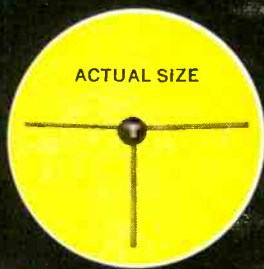

ACTUAL SIZE

NEW FROM
Transitron

micro-T

(A MESA MICRO-TRANSISTOR)

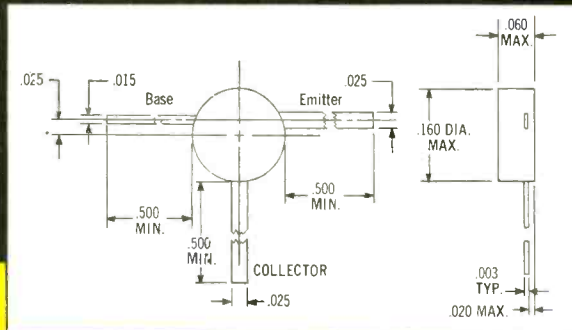

- SILICON DIFFUSED
- HERMETICALLY-SEALED
- ALL-GLASS PACKAGE

INTRODUCING THE FIRST SERIES IN A COMPLETE LINE OF MICRO-TRANSISTORS

Development of the MICRO-T — first silicon diffused mesa micro-transistor in an hermetically sealed all-glass package — represents a major step forward in microminiaturization. As compared with conventional “metal can” configurations, the MICRO-T’s hard glass packaging embodies a significant improvement in the hermetic seal between leads and package. Reliability is substantially increased; possibility of leakage is sharply reduced.

This new series of 45-volt micro-transistors is the first designed for small-signal low-level applications, with current operating range from 50 microamps to 20 milliamps. Other electrical characteristics include an R_{cs} of 100 to 200 ohms; minimum Betas from 20 to 80; cut-off frequencies of over 50 megacycles. Perfectly compatible with present circuitry, MICRO-T’s will facilitate microminiaturizing in such critical areas as airborne, space vehicle and missile application. They are 1/20th the size of the TO-5, and 1/5th that of the TO-18.

The first five types of MICRO-T’s are available now. For full information, write for Bulletins No. PB-78, (Amplifier types) and PB-79, (Switching types).

**MEET US AT IRE —
BOOTH NOS. 1220-1224**

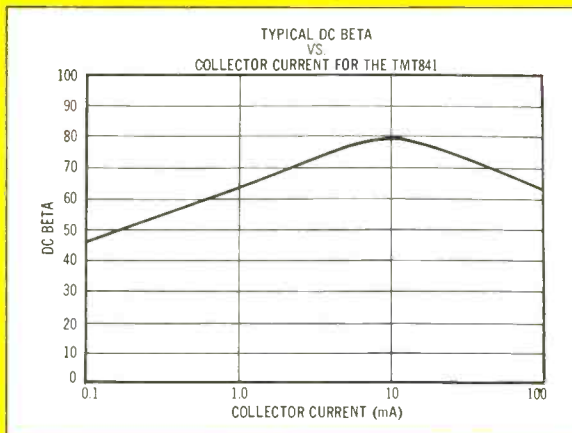

AMPLIFIER TYPES					
Type	Maximum Collector Voltage (Volts)	Minimum AC Beta (h_{fe})	Typical Gain-Bandwidth Product (Mc)	Maximum Collector Leakage Current at 25°C (μA)	Maximum Power Dissipation at 25°C Ambient (mW)
TMT 839	45	20	45	1	150
TMT 840	45	40	45	1	150
TMT 841	45	80	65	1	150
SWITCHING TYPES					
Type	Maximum Collector Voltage (Volts)	Minimum DC Beta (h_{FE})	Typical Gain-Bandwidth Product (Mc)	Maximum Saturation Resistance (Ohms)	Maximum Power Dissipation at 25°C Ambient (mW)
TMT 842	45	20	45	120	150
TMT 843	45	45	65	120	150

Transitron



electronic corporation
wakefield, melrose, boston, mass.

SALES OFFICES IN PRINCIPAL CITIES THROUGHOUT THE U.S.A. AND EUROPE • CABLE ADDRESS: TRELCO

from first call
to fast
delivery . . .

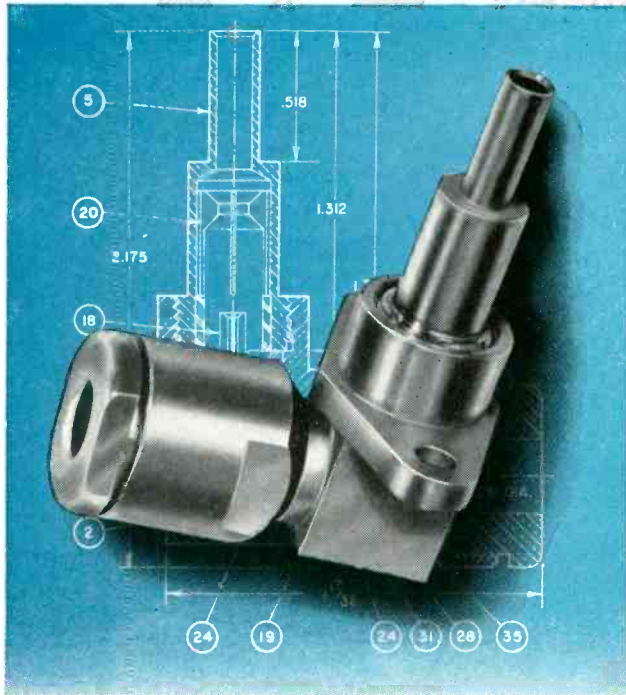

GREMAR

sets the pace in special RF connectors!

Connecting an Eimac Klystron to RG-126/U cable calls for a special, low VSWR adapter. Gremar designed and delivered it in days . . . not weeks. Other examples of Gremar's fast delivery of specials include strip transmission line to co-ax adapters, crystal adapters and many other special RF connectors.

Gremar's special delivery capabilities are based on a constant inventory of 500,000 assembled units of more than 2000 types of RF connectors and adapters . . . plus more than 4,000,000 component parts ready for adapting to most problem specifications. And when components do not exist, Gremar makes them fast.

What is your problem? Because Gremar connectronics® concentrates engineering, production and quality control on RF connectors and components only, your requirements receive the specialized attention that slashes design-to-delivery time . . . as our customers testify. For all the facts fast . . . on standards or specials . . . contact:



descriptive brochure available on request



GREMAR

MANUFACTURING COMPANY, INC.
RELIABILITY THROUGH QUALITY CONTROL
Dept. E, Wakefield, Mass., CRystal 9-4580

(Continued from page 50)

kenstein and myself. I am very pleased with the readability of the paper as presented in your magazine and want to thank you for both an excellent lay-out and a good job of editing.

ELECTRONIC INDUSTRIES is earning a fine reception for itself on engineers' desks because of its diversified articles of good technical substance and its obvious concern with providing the best presentation of each paper. It was a privilege to have been a contributing author.

C. Louis Cuccia
Microwave Engineering

Radio Corporation of America
Electron Tube Division
Harrison, N. J.

Binary-to-Analog

Editor, ELECTRONIC INDUSTRIES:

I wish to call attention to a recent article in the September issue of ELECTRONIC INDUSTRIES.

S. W. Torode and D. Disinger of Sylvania Electronic Systems, presented a technique for converting Binary Codes to Analog. They used a rectangular "AND" Matrix without utilizing the redundancies to reduce the number of diodes required to construct it. It is true that in the example presented the code redundancy is used to output zero signals to all amplifiers.

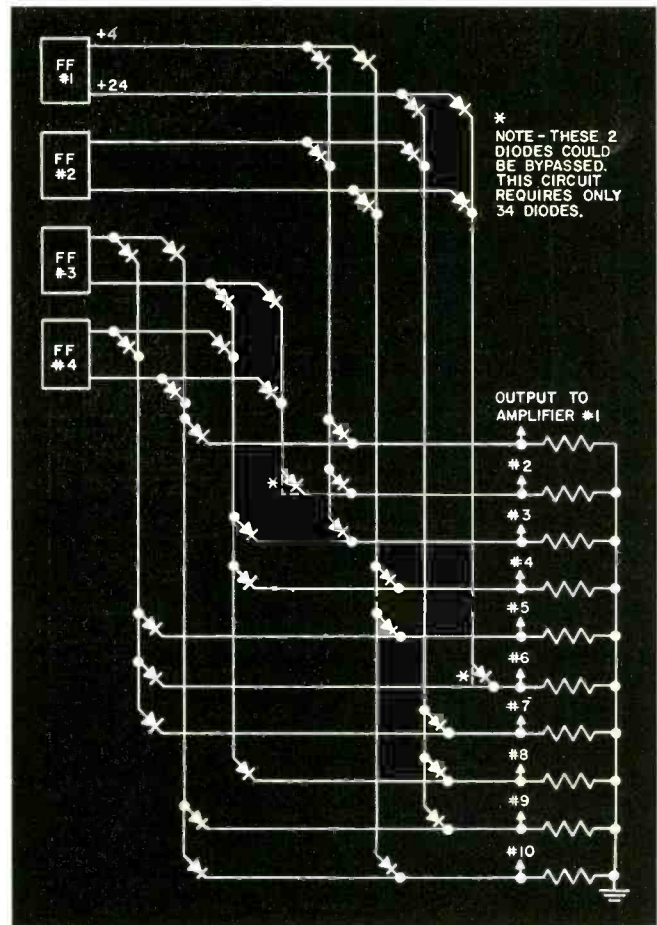

However, a diode reduction of 10% may be achieved by using a Sectional Matrix rather than a Rectangular Matrix. This is feasible only when a voltage drop across two diodes can be tolerated. In this case, I do not think that this would be a limitation.

I am presenting a revised matrix which I designed, requiring 10% less diodes than that designed by Torode and Disinger.

John E. Croy

Burroughs Corporation
Electrodata Division
460 Sierra Madre Villa, Pasadena, Calif.

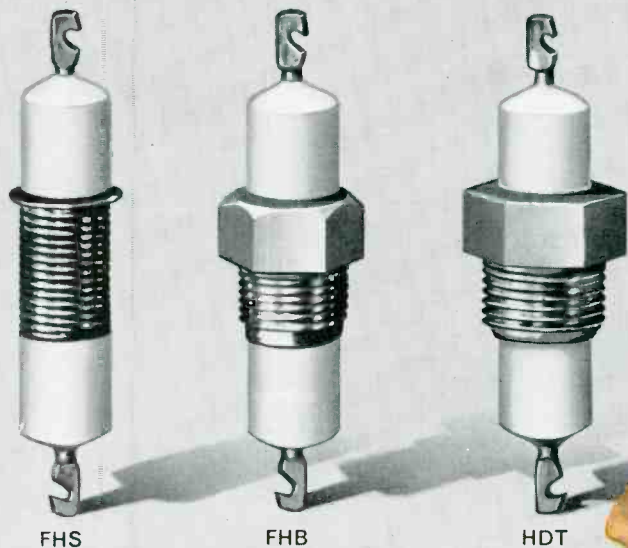

These Miniature Low Pass High Frequency Filters*

Eliminate Spurious R.F. Radiation and Troublesome Feedback

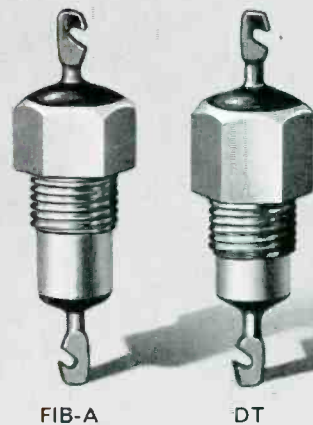

*Shown here one and one half actual size

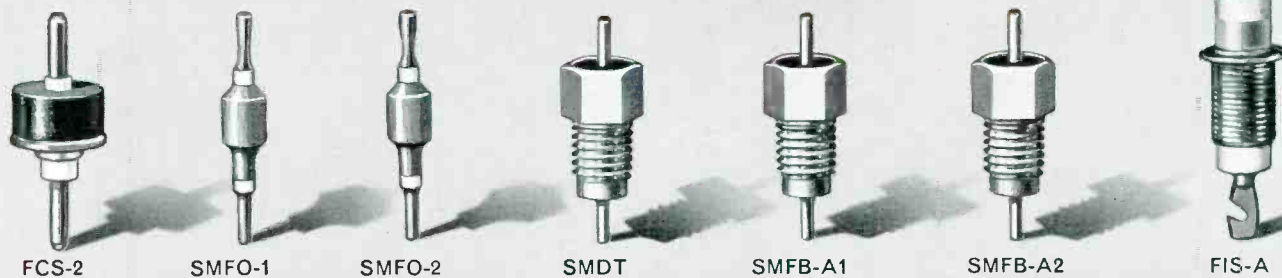

Allen-Bradley Low Pass Filters

Prevent Undesired Radiation...100 Mcps to 8000 Mcps

Where—at high frequencies—conventional feed-thru capacitors become useless—these Allen-Bradley low pass filters insure effective filtering of undesired frequencies. Their performance surpasses the theoretically ideal capacitor—the effective filtering actually increases with frequency over a wide band. And here's another "plus" feature—there are none of the undesirable parallel resonances experienced with standard tubular

capacitors. Thus, unusual attenuation—75 db and more—is possible in the frequency range from 100 Mcps to 8000 Mcps.

Although designed for low power applications, the Allen-Bradley low pass filters are available in ratings up to 2000 volts and with maximum d-c or low frequency a-c current ratings up to 20 amperes. These miniature filters provide single hole mounting—directly on metal shields. Also, they are usually interchangeable with conventional feed-thru capacitors, but provide far greater suppression of undesired radiation and feedback. Send for Technical Bulletin 5410.

Allen-Bradley Co., 222 W. Greenfield Ave., Milwaukee 4, Wis. • In Canada: Allen-Bradley Canada Ltd., Galt, Ont.

ALLEN-BRADLEY

Quality
Electronic
Components



WATERTIGHT CASE
Molded enclosure is sealed against moisture and permits encapsulation.

SHOCK RESISTANCE
High contact pressure of molded carbon brush against molded-in resistance surface assures continuously reliable operation.

FINE CONTROL
Continuous resistance change provided over approximately 25 complete turns.

SMOOTH ADJUSTMENT
Solid molded resistance tracks permit stepless adjustment.

Guaranteed

*Reliable
Performance
and
Stable
Settings*

**UNDER EXTREME
ENVIRONMENTAL
CONDITIONS**

In critical applications, Allen-Bradley Type R adjustable fixed resistors are *without equal*. For example, in recent tests* Type R resistors successfully withstood acceleration, shock, and vibration *five times* better than the latest MIL Spec requirements. Such wide margin of safety is your assurance of complete reliability. Virtual indestructibility is obtained through an *exclusive* Allen-Bradley process in which the solid resistance elements and the insulating mounting are hot molded into one integral unit. The moving element is self-locking for absolutely stable settings. Also, the Type R control allows "stepless" adjustment of its resistance.

The molded case of the Type R control is watertight and dust-tight. Rated 1/4 watt at 70°C, these Type R controls are available in values from 100 ohms to 2.5 megohms.

*Test Report #71801, Sept. 1960, United States Testing Company.

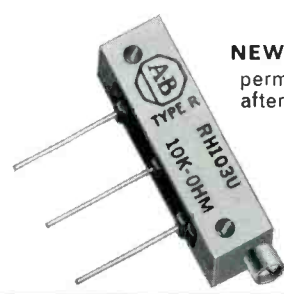

NEW CUP GUARD
permits adjustment after encapsulation

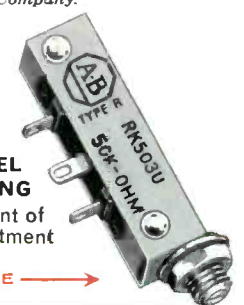

NEW PANEL MOUNTING
permits front of panel adjustment

← ACTUAL SIZE →

ALLEN-BRADLEY

Allen-Bradley Co., 222 W. Greenfield Ave., Milwaukee 4, Wis.
In Canada: Allen-Bradley Canada Ltd., Galt, Ont.

**QUALITY
ELECTRONIC
COMPONENTS**

Books

Introduction to Ceramics

By W. D. Kingery. Published 1960 by John Wiley & Sons, Inc., 440 Fourth Ave., New York 16, N. Y. 781 pages. Price \$15.00.

This book is a pioneer in a new field of physical ceramics and a new approach for an introductory ceramics text book. Instead of considering industry division and specialized small classes of materials, it is general in conception and is based on a rational approach to ceramic phenomena and properties—densification during firing, strength, etc. In this way traditional ceramic compositions and recent space age uses and functions of ceramics are placed in proper perspective for the materials science student and the practicing specialist.

It is the only book of this nature available in the field and features extensive descriptions of the microstructure and properties of ceramics as illustrative material for the application of physical ceramics to real problems.

Principles of Feedback Control

By C. H. Wilts. Published 1960 by Addison-Wesley Publishing Co., Inc., Reading, Mass. 271 pages. Price \$8.75.

This book is a clear rigorous treatment of the analytical methods used in the design of feedback systems. It is intended for use as a text book in courses at the advanced undergraduate-graduate level, and for practicing engineers who wish to study the principles of feedback control.

It is assumed that the reader has a good background in ordinary differential equations and complex variable theories; this latter prerequisite may be satisfied, however, by a concurrent course in the subject. Although desirable, it is not necessary that the student have any formal training in the use of the Laplace transform for solving linear differential equations.

The stability problem is the main theme of the work. Attention is given to the fundamental aspects of the problem, to the Routh-Hurwitz and Nyquist tests, to the generalized concepts of a route locus, and finally to the problem of creating a satisfactory degree of relative stability in systems that are either unstable or insufficiently stable. The author presents a carefully balanced choice of methods and viewpoints, with the frequency-response and the route-locus point of view employed in alternate solutions. The reader is thus equipped with a comprehensive set of tools of analysis and a broad point of view.

(Continued on page 62)

CIRCUIT FOR FUTURE REFERENCE

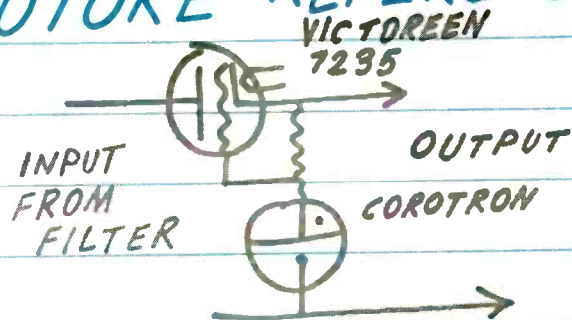

INPUT V	OUTPUT V	% REG
2000	1500	} 2½ %
2100	1510	
2200	1520	
2300	1530	
2400	1540	

GIVES SIMPLE, EFFECTIVE VOLTAGE
REGULATION USING VICTOREEN
7235 HV TRIODE...

E_p MAX = 10,000v MU = 550
 I_p MAX = 5ma SIZE - 76-½
 P_p MAX = 12w BASE - 9pin MIN

FOR REFERENCE, LOOK INTO VICTOREEN
COROTRONS* AVAILABLE IN VOLTAGES
FROM 900 TO 27 Kv.

NOTE - WRITE FOR DESIGN DATA AND
PERFORMANCE SPECS. TO
APPLICATION ENG. DEPT.

* CORONA TYPE VOLTAGE REGULATORS



Victoreen

5806 Hough Avenue • Cleveland 3, Ohio
Export Department, 240 West 17th St., New York 17, N.Y.

A-2470A

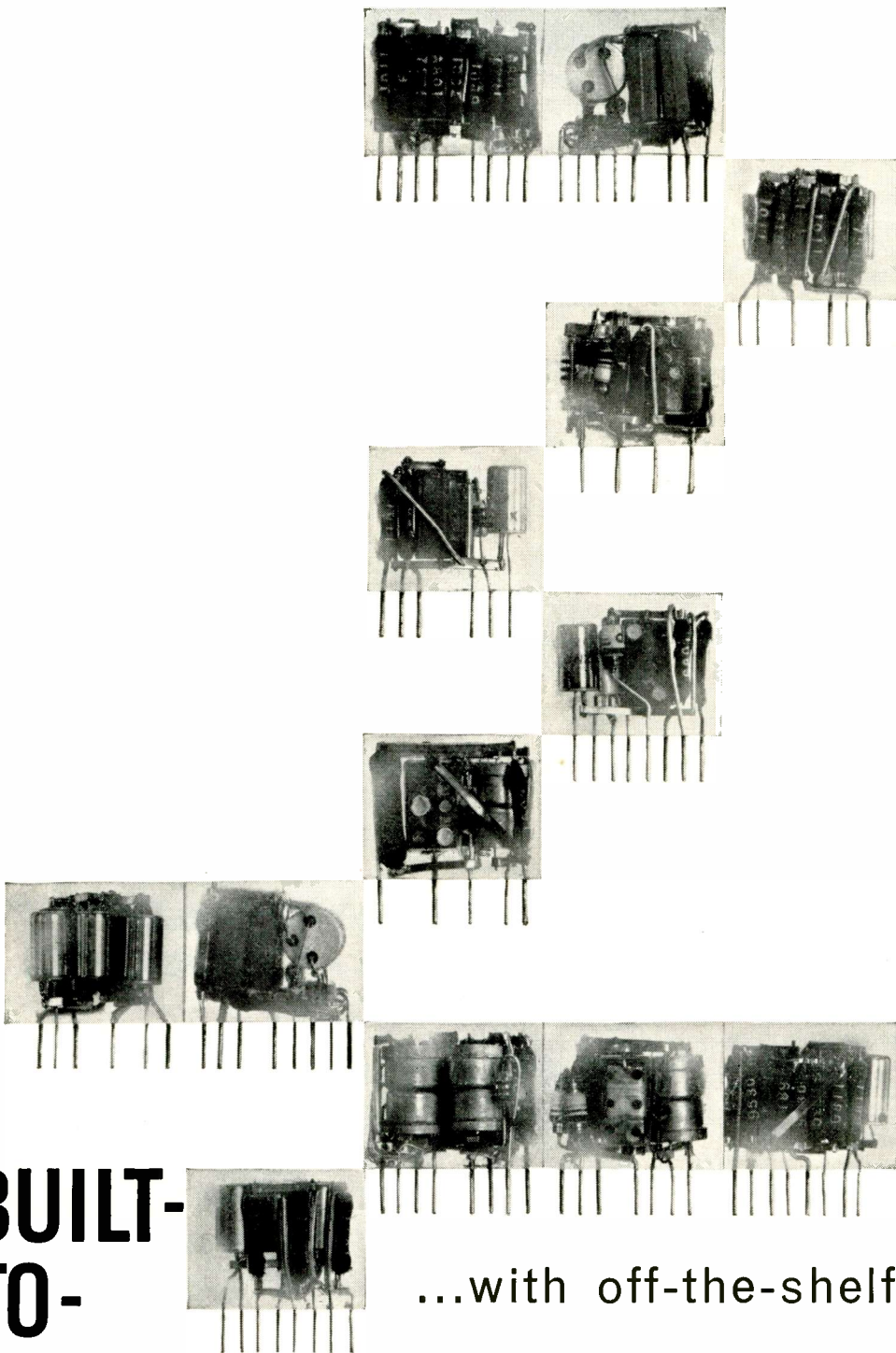

BUILT- TO- ORDER COMPUTERS

...with off-the-shelf components

Delco Radio can design, develop and deliver digital computers with the speed you need, for airborne guidance and control as well as a wide variety of other special applications. ■ With off-the-shelf Delco transistorized digital circuits, we have, for example, built a computer for a military application in less than three months. ■ These miniature modules contain standard components. They satisfy all MIL-E-5272D (ASG) requirements, which assures extremely rugged, reliable computers. Continuing life tests on these computer circuits now exceed four and one-half million transistor hours *without a failure*. And where space is no problem, you can have these same, reliable digital circuits packaged on plug-in circuit cards. ■ Delco Radio has six sections of highly experienced people with the necessary capabilities to produce complete computer systems: Application Analysis, Systems, Logic, Memory, Circuit Design and Advanced Development. May we review your requirements? Just contact our Sales Department. ■ *Physicists and Electronics Engineers: Join Delco Radio's search for new and better products through Solid State Physics.*

PIONEERING ELECTRONIC PRODUCTS THROUGH SOLID STATE PHYSICS



Division of General Motors • Kokomo, Indiana

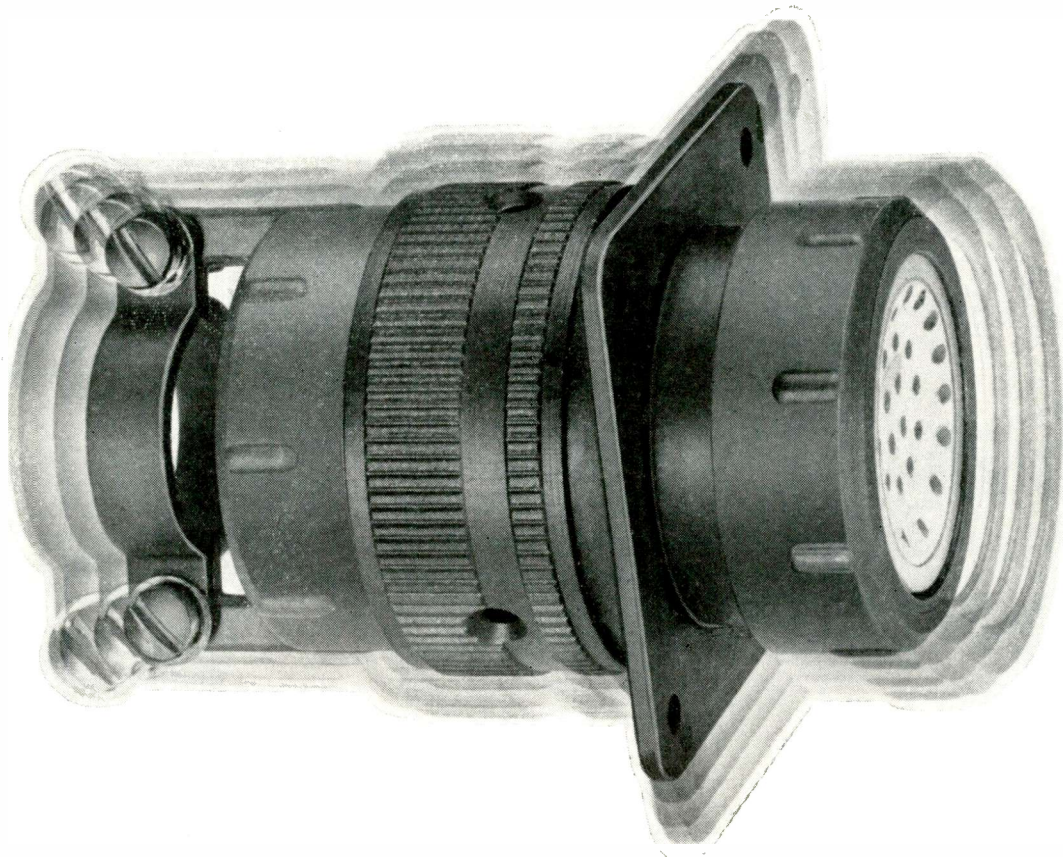

VIBRATION PROOF CANNON PLUGS

Reliability for Industry • Aircraft • Space Vehicles Cannon's full line of vibration-proof plugs are engineered to meet the most stringent demands of industry, missiles, and aircraft. If you have a problem in vibration, let us provide the answer. From umbilical plugs to the most versatile subminiatures... for any ground or airborne use, Cannon vibration-proof plugs surpass what is expected of them. Another reason why you should always consult the first name in plugs...why you should consult Cannon for all your plug requirements. For information on these or other Cannon products write to:

CANNON ELECTRIC COMPANY, 3208 Humboldt St., Los Angeles 31, Calif.



SPEEDING UP ASSEMBLY LINE WITH KLEIN ELECTRONIC PLIERS

SHEAR CUTTING PLIERS

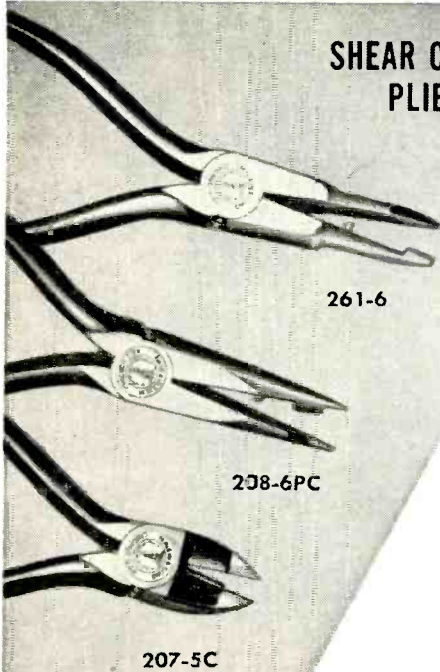

LONG NOSE PLIERS

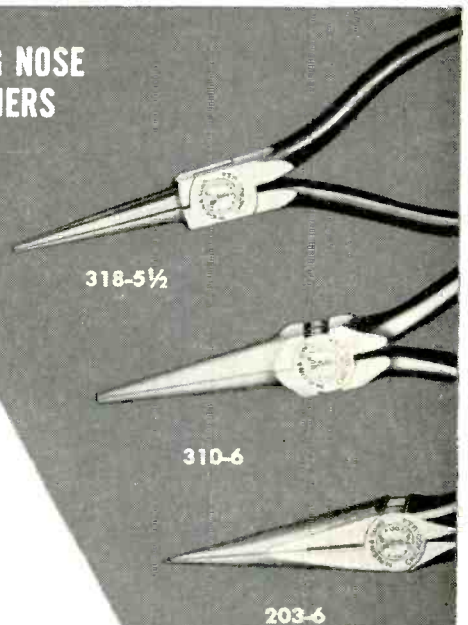

In the rapidly growing field of electronics, there is an increasing need for highly specialized pliers. While you're using a plier designed to do a particular job, not only is assembly speeded up but better performance is assured.

Our own engineers, working with electronic manufacturers, have developed many pliers that serve the specialized needs of this field.

On this page are shown a few of the many pliers available in the complete Klein line.

WRITE FOR CATALOG

If you do not have a copy of the new Klein Catalog 103A illustrating and describing Klein Pliers, write for a copy. It will be sent without obligation.

ASK YOUR SUPPLIER

Foreign Distributor:
International Standard
Electric Corp., New York

MIDGET PLIERS

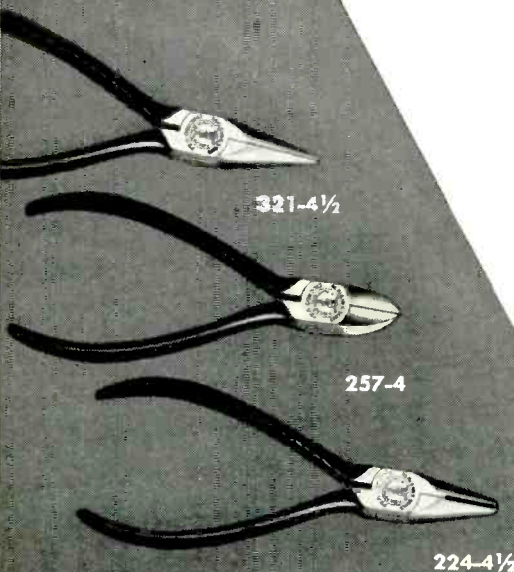

OBLIQUE CUTTERS

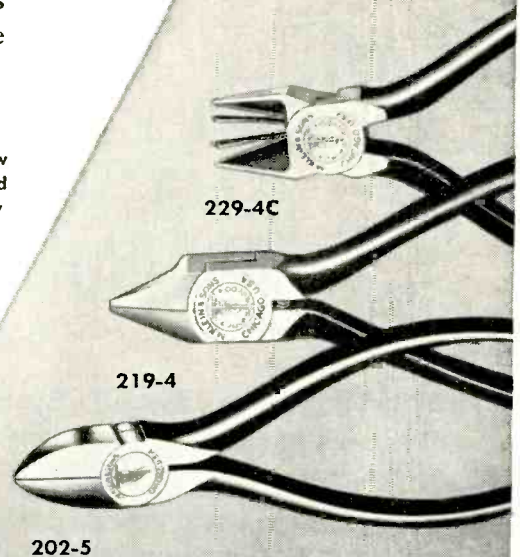

Mathias KLEIN & Sons
Established 1857 Chicago, Ill., U.S.A.
7200 McCORMICK ROAD • CHICAGO 45, ILLINOIS

Shrinker Cum Laude



Know ye that we, the corporation of Burnell & Co., upon the recommendation of our customers in the electronics industry do hereby inaugurate the esteemed order of Shrinker Cum Laude.

Be it further known that, (without undue modesty), the Shrinker Cum Laude award has been made to Burnell for displaying the highest degree of shrinkmanship in the design and utilization of microminiature, subminiature and miniature toroids, filters and related networks.

The Shrinker Cum Laude award has also been tendered for signal

achievement in reducing developmental costs while increasing performance range—a feat accomplished by the designers of the new Burnell high selectivity, high attenuation, 1 kc crystal filter which possesses the following unique characteristics:

Attenuation — 3 db bandwidth — 3.8 cps
 Shape Factor 60/6 — 4½:1
 Input — 500 ohms
 Output Impedance—500,000 ohms
 Meets MIL-C 3908 B vibration standards

Other Burnell crystal filters available in frequencies up to 30mcs with

considerable latitude in impedance range. Write for Bulletin XT 455.

See the complete line of Burnell components at Booths 2919-2921 IRE Exhibit, March 20-23.

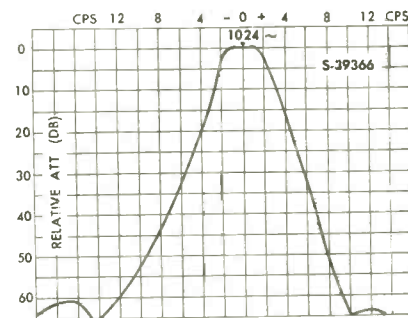

COPYRIGHT 1961 • BURNELL & CO., INC.

Burnell & Co., Inc.

PIONEERS IN microminiaturization OF TOROIDS,
 FILTERS AND RELATED NETWORKS

EXECUTIVE OFFICE
 AND PLANT
 DEPT. 1-31
 PELHAM, NEW YORK
 PELHAM 8-5000
 TELETYPE PELHAM 3633



PACIFIC DIVISION
 SOUTH PASADENA, CAL.
 MFD. IN CANADA
 BY EDO (CANADA) LTD.
 CORNWALL, ONT.
 WELLINGTON 2-6774

Constructive discontent at Ampex...

... has been setting instrumentation standards for years

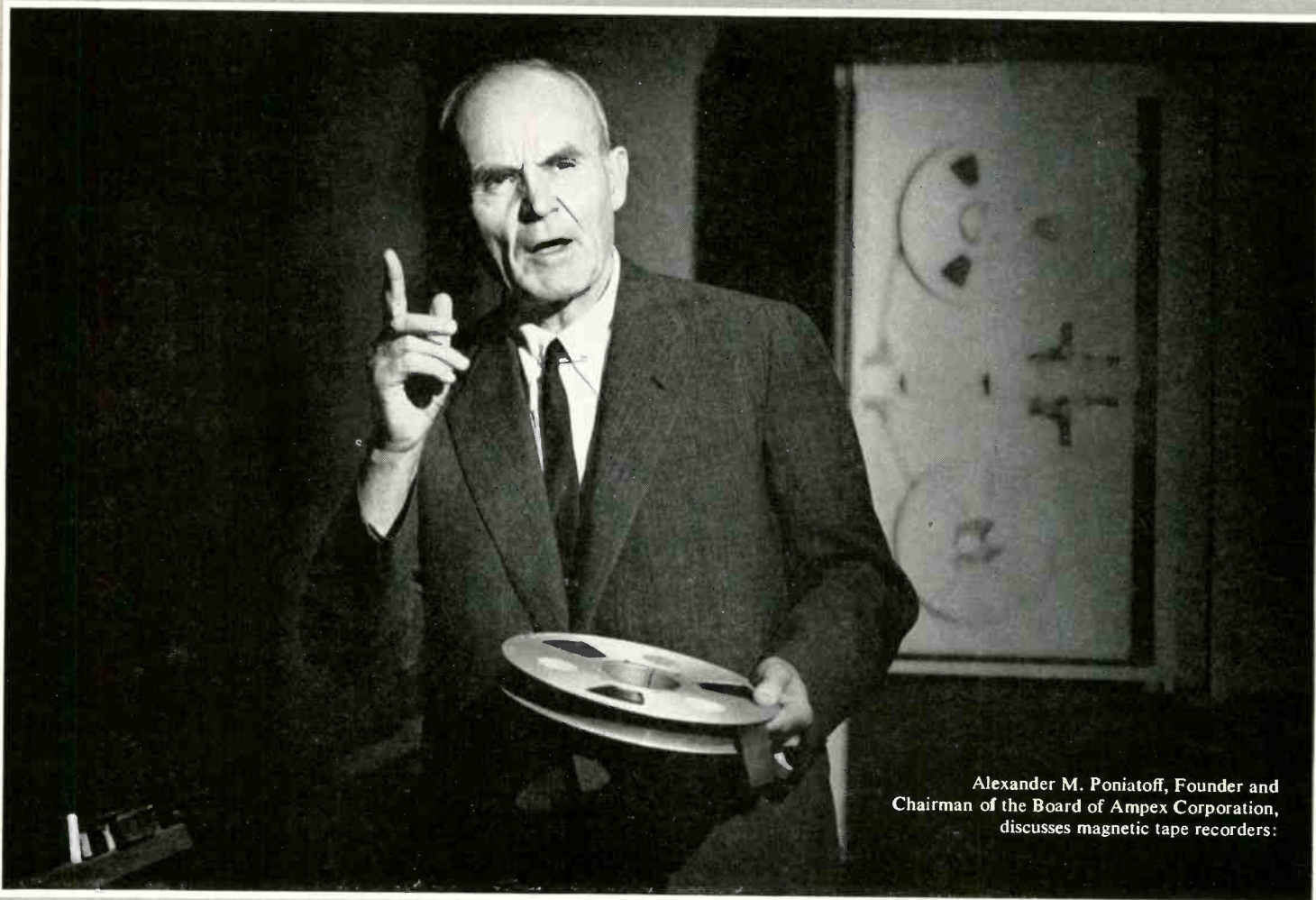

Alexander M. Poniatoff, Founder and Chairman of the Board of Ampex Corporation, discusses magnetic tape recorders:

"Everything Ampex recorders stand for — service, quality, reliability, technological leadership — stems from this attitude.

"The first commercial 'live-quality' audio recorder was developed by Ampex because of the disc record's fidelity drawbacks. Discontent with the capabilities of all data recorders using visual traces spurred Ampex's evolution of special purpose magnetic tape data recorders. Frequency limitations bothered us, so we gave you the 4-megacycle FR-700.

"A need for compact equipment with high performance caused us to introduce the CP-100 — a transistorized 200 kc 14-track data recorder less than 7 cu. ft. small. Striving for versatility and high efficiency, we perfected the FR-600; it records 500 kc at 120 ips — double the previous standard, but still fully compatible.

Circle 55 on Inquiry Card

"And we were even constructively discontented with the way we made these advanced recorders available to you. Now, Ampex instrumentation recorders can be leased or purchased on time as well as outright. You can free working capital for other projects, and invest in your Ampex data recorder as it works for you."

Some significant specifications:

AR-300, FR-700: 10 cps to 4 mc ± 3 db; 12½ and 25 ips record and playback. FM recording. Two data, two auxiliary tracks. 2" tape, 10½" reels. AR-300 airborne record only.

CP-100: 300 cps to 200 kc ± 3 db at 60 ips; 60, 30, 15, 7½, 3¾, 1⅞ ips with proportional response. Direct or FM recording. All-transistorized. ½" or 1" tape, 10½" reels.

FR-600: 300 cps to 500 kc ± 3 db at 120 ips; 60, 30, 15, 7½, 3¾, 1⅞ ips with proportional response. Direct, PDM or FM recording by plug-in modules. ½" or 1" tape, 10½" or 14" reels.

For detailed information on the complete Ampex line of data recorders, write:
AMPEX INSTRUMENTATION PRODUCTS COMPANY
Box 5000, Redwood City, California

AMPEX

Experienced engineers eager to contribute to Ampex's pioneering reputation are invited to write the Manager, Technical Recruiting.

**FIRST
MIL TYPE
germanium
MESA SWITCHING
TRANSISTOR**

USN 2N705*

now available from...
MOTOROLA



ACTUAL SIZE

*
TO MEET
REQUIREMENTS OF
MIL-S-19500/86 (NAVY)

MOTOROLA USN 2N705			
ELECTRICAL CHARACTERISTICS at 25°C			
PARAMETER	SYMBOL	RATING	UNIT
Collector-Base Voltage	V_{CB}	15	V _{cc}
Collector-Emitter Voltage	V_{CE}	15	V _{cc}
Emitter-Base Voltage	V_{EB}	3.5	V _{dc}
Collector Dissipation @ 25°C Case Temp	P_c	300	mW
Collector Dissipation @ 25°C Ambient Temp	P_o	150	mW
Forward Current Transfer Ratio	f_{FE}	25 min	—
Base-Emitter Voltage	V_{BE}	0.35 min — 0.44 max	V _{dc}
Collector Saturation Voltage ($I_B = -4$ mA _{dc} , $I_C = 10$ mA _{dc})	$V_{CE(SAT)}$	0.3 max	V _{dc}
Storage Time	t_s	100 max	nsec
Fall Time	t_f	100 max	nsec
Delay + Rise Time	$t_d + t_r$	75 max	nsec
Junction Temperature	T_j	100	°C

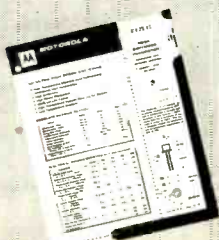

**FOR COMPLETE
TECHNICAL INFORMATION**
on the Motorola USN 2N705,
write for Data Sheet.
Please address inquiries to
**MOTOROLA SEMICONDUCTOR
PRODUCTS INC., Technical Information
Department, 5005 E. McDowell Road,
Phoenix, Arizona**

The USN 2N705 is a PNP germanium high-frequency mesa switching transistor. It is ideal for use wherever high-speed switching is necessary, such as flip-flop, gate and trigger circuits. Reliable operation in switching circuits has been achieved at frequencies in excess of 40 megacycles.

Units are immediately available. Order from your authorized Motorola Semiconductor distributor or your Motorola district office.

MOTOROLA SEMICONDUCTOR DISTRICT OFFICES:

- BOSTON 385 Concord Ave., Belmont 78, Mass.IVanhoe 4-5070
- CHICAGO 39, 5234 West Diversey AvenueLAvenue 2-4300
- DALLAS 19, 3915 Lemmon AvenueLAKeside 6-8931
- DAYTON 3120 Far Hills Avenue, Dayton, OhioAXminster 3-4164
- DETROIT 27, 13131 Lyndon AvenueBRoadway 3-7171
- LOS ANGELES 1741 Ivar Avenue, Hollywood 28, Calif.HOLlywood 2-0821
- MINNEAPOLIS 27, 7731 6th Avenue NorthLiberty 5-2198
- NEW YORK 1051 Bloomfield Ave., Clifton, N.J.GRegory 2-5300
from New YorkWIsconsin 7-2980
- ORLANDO KnoWel Building, Winter Park, Fla.Midway 7-2507
- PHILADELPHIA 130 South Easton Rd., Glenside, Pa.TUrner 7-7020
from PhiladelphiaWAverly 7-6144
- SAN FRANCISCO 1299 Bayshore Highway, Burlingame, Calif.DIAMond 2-3228
- SYRACUSE 101 South SalinaGRanite 4-3321
- WASHINGTON 8605 Cameron St., Silver Spring, Md.JUUniper 5-4485

Circle 56 on Inquiry Card

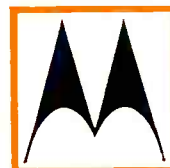

MOTOROLA
Semiconductor Products Inc.

A SUBSIDIARY OF MOTOROLA, INC.

Books

(Continued from page 55)

Digital Applications of Magnetic Devices

Edited by Albert J. Meyerhoff. Published 1960 by John Wiley & Sons, Inc., 440 Fourth Ave., New York 16. 604 pages. Price \$14.00.

This book provides the necessary theory for the design of the major digital magnetic circuit types, and complete design examples of several specific systems. The book is sufficient, in many cases, to enable the professional computer engineer to determine the solution to such problems as: the suitability of a magnetic circuit; the specific component types to be employed; design procedures necessary to design complete systems. Specific steps and equations involved in circuit design; and, in great detail, the particular effects of specific parameters of magnetic characteristics and geometry on circuit design and performance.

The Control of Multi-Variable Systems

By Mihajlo D. Mesarovic. Published 1960 by the Technology Press, Massachusetts Institute of Technology and John Wiley & Sons, Inc., 440 Park Ave. So., New York 16. 112 pages. Price \$3.50.

This book suggests that future theory about control systems should rest on a multi-variable, rather than single-variable, foundation.

Asserting that interaction and uncertainty are the main properties of multi-variable control systems, the book recommends specific control structural patterns.

The book says that the Cybernetical approach causes discrepancies at the engineering level that can be reduced "only by theory based on true multi-variable models and not on single-variable abstractions."

The author uses a V-canonical structure with a feedback controller as the model for his multi-variable theory, replacing the P-structure when the system is of an interrelated kind. He outlines situations to illustrate when, and in which combinations, PVH structures are suitable.

The Encyclopedia of Spectroscopy

Edited by George L. Clark. Published 1960 by Reinhold Publishing Corp., 430 Park Ave., New York 22. 787 pages.

This book offers an authoritative survey of the entire field of spectroscopy. Beginning with a masterly treatment of Absorption spectrophotometry and running alphabetically through X-ray emission spectra, the volume contains a wealth of remarkably condensed, clearly presented articles on all branches of spectroscopy.

(Continued on page 70)



The "QUALITY" name for PHENOLIC TUBING

To make your product better . . . and at lower costs . . . specify CLEVELITE*!

High performance factors, uniformity and inherent ability to hold close tolerances, make Clevelite outstanding for coil forms, collars, bushings, spacers and cores.

Wherever high dielectric strength, low moisture absorption, mechanical strength and low loss are of prime importance . . . the combined electrical and physical properties of Clevelite are essential.

Fast, dependable deliveries at all times!

Write for a copy of our new Clevelite brochure.

* Reg. U. S. Pat. Off.

PLANTS & SALES OFFICES:

CLEVELAND
DETROIT
CHICAGO
MEMPHIS
DALLAS
LOS ANGELES
PLYMOUTH, WISC.
JAMESBURG, N. J.

THE CLEVELAND CONTAINER COMPANY

6201 BARBERTON AVE., CLEVELAND 2, OHIO
ABRASIVE DIVISION at CLEVELAND, OHIO

REPRESENTATIVES:

NEW ENGLAND: R. S. PETTIGREW & CO.
10 N. MAIN ST., W. HARTFORD, CONN.

NEW YORK AREA: MURRAY SALES CO.
25 W. NORTHFIELD RD., LIVINGSTON, N. J.

PHILADELPHIA: MIDLANTIC SALES CO.
9 E. ATHENS AVE., ARDMORE, PA.

CHICAGO AREA: McFARLANE SALES CO.
5950 W. DIVISION ST., CHICAGO

WEST COAST: BERT BARRON COMPANY
15166 VENTURA BLVD., SHERMAN OAKS, CALIF.

CANADA: PAISLEY PRODUCTS CO. LTD.
36 UPTON RD., SCARBOROUGH, ONT.

CLEVELAND
CONTAINER
CANADA, LTD.
TORONTO &
PRESCOTT, ONT.

SALES OFFICES:

NEW YORK
WASHINGTON
MONTREAL

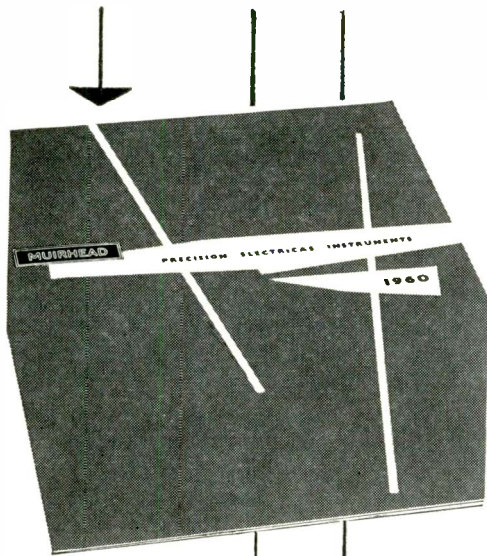

Have you had
your copy?

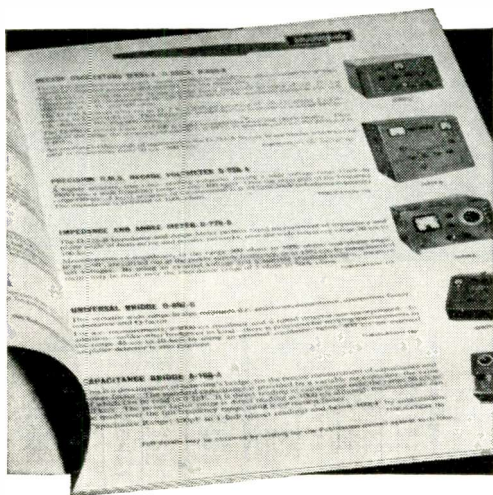

The new MUIRHEAD abridged catalogue briefly describes the latest instruments in production and quotes the reference numbers of the publications which more fully describe individual types.

Send for your free issue today.

MUIRHEAD
PRECISION ELECTRICAL
INSTRUMENTS

MUIRHEAD & CO. LIMITED,
Beckenham, Kent.

a.c. voltage
measurements
to 0.05%

using the

D-930-A

MUIRHEAD-WIGAN

PRECISION

R.M.S. DECADE

VOLTMETER



A sensitive, true r.m.s. reading instrument with outstanding features :

- ★ Wide voltage range, 1mV—300V
- ★ Wide frequency range, 5 c/s—100 kc/s
- ★ High accuracy (basically 0.05%)
- ★ Reading accuracy $\pm 0.025\%$ at all points
- ★ Built-in standardizing circuit
- ★ Ideal for industrial and laboratory applications
- ★ Easy to use
- ★ 4-way protected against mis-use

WRITE FOR PUBLICATION 150

MUIRHEAD
Precision Electrical Instruments

MUIRHEAD INSTRUMENTS INC., 441 Lexington Avenue, New York, 17, N.Y., U.S.A.
Telephone: Murray Hill 2-8131

MUIRHEAD & CO. LIMITED, Beckenham, Kent, England
Telephone: Beckenham 4888

MUIRHEAD INSTRUMENTS LIMITED, Stratford, Ontario, Canada
Telephone: 271-3880

489/3

Tarzian Silicon Voltage Regulators for Tomorrow's Circuits in Design Today

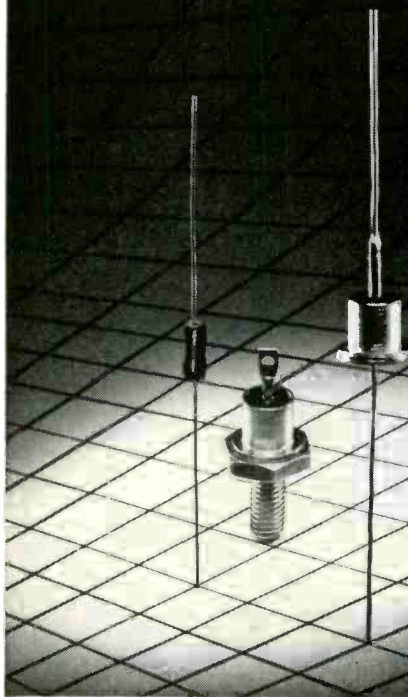

TARZIAN SILICON VOLTAGE REGULATORS—in 1/4-watt, 1-watt and 10-watt classifications—will serve you well as DC power regulators, AC clippers and limiters, and as protective devices in a wide variety of component protection circuits.

Their small size, inherent ruggedness, and physical simplicity are distinct improvements over other types of regulators. Sharp and instantaneous breakdown (avalanche) characteristics and instantaneous recovery are invitations to inventiveness in circuit design.

Tarzian silicon regulators, like Tarzian silicon rectifiers, are made with a unique blend of care and ingenuity that delivers excellent quality at a realistic price. They are available now from factory or warehouse stocks in sample or volume production quantities. Application engineering service is offered without obligation.

Quality in volume



SARKES TARZIAN, INC.

World's Leading Manufacturers of TV and FM Tuners • Closed Circuit TV Systems • Broadcast Equipment • Air Trimmers • FM Radios • Magnetic Recording Tape • Semiconductor Devices
SEMICONDUCTOR DIVISION • BLOOMINGTON, INDIANA
In Canada: 700 Weston Rd., Toronto 9 • Export: Ad Aurlima, Inc., New York

1/4 Watt Voltage Regulators					1 Watt Voltage Regulators					10 Watt Voltage Regulators				
Specifications 25°C.					Specifications 25°C.					Specifications 25°C.				
Tarzian Type	Zener Volt. (V)	Test Cur. (mA)	Dyn. Imp. (Ohms)	Indec. Type	Tarzian Type	Zener Volt. (V)	Test Cur. (mA)	Dyn. Imp. (Ohms)	Indec. Type	Tarzian Type	Zener Volt. (V)	Test Cur. (mA)	Dyn. Imp. (Ohms)	Indec. Type
.2575.6	5.6	25	3.6	1N708	175.6	5.6	100	1.2	1075.6	5.6	1000	1	1N1803	
.2576.2	6.2	25	4.1	1N709	176.2	6.2	100	1.5	1076.2	6.2	1000	1	1N1804	
.2576.8	6.8	25	4.7	1N710	176.8	6.8	100	1.7	1076.8	6.8	1000	1	1N1805	
.2577.5	7.5	25	5.3	1N711	177.5	7.5	100	2.1	1077.5	7.5	1000	1	1N1806	
.2578.2	8.2	25	6.0	1N712	178.2	8.2	100	2.4	1078.2	8.2	1000	1	1N1807	
.2579.1	9.1	12	7.0	1N713	179.1	9.1	50	3.0	1079.1	9.1	500	1	1N1808	
.25710	10	12	8.0	1N714	1710	10	50	3.3	10710	10	500	2	1N1351	
.25711	11	12	9.0	1N715	1711	11	50	4.2	10711	11	500	2	1N1352	
.25712	12	10	10	1N716	1712	12	50	5.0	10712	12	500	2	1N1353	
.25713	13	12	11	1N717	1713	13	50	5.8	10713	13	500	2	1N1354	
.25715	15	12	13	1N718	1715	15	50	7.6	10715	15	500	2	1N1355	
.25716	16	12	15	1N719	1716	16	50	8.6	10716	16	500	3	1N1356	
.25718	18	12	17	1N720	1718	18	50	11	10718	18	150	3	1N1357	
.25720	20	4	20	1N721	1720	20	15	13	10720	20	150	3	1N1358	
.25722	22	4	24	1N722	1722	22	15	16	10722	22	150	3	1N1359	
.25724	24	4	28	1N723	1724	24	15	18	10724	24	150	3	1N1360	
.25727	27	4	35	1N724	1727	27	15	23	10727	27	150	3	1N1361	
.25730	30	4	42	1N725	1730	30	15	28	10730	30	150	4	1N1362	
.25733	33	4	50	1N726	1733	33	15	33	10733	33	150	4	1N1363	
.25736	36	4	60	1N727	1736	36	15	39	10736	36	150	5	1N1364	
.25739	39	4	70	1N728	1739	39	15	45	10739	39	150	5	1N1365	
.25743	43	4	84	1N729	1743	43	15	54	10743	43	150	6	1N1366	
.25747	47	4	98	1N730	1747	47	15	64	10747	47	150	7	1N1367	
.25751	51	4	115	1N731	1751	51	15	74	10751	51	150	8	1N1368	
.25756	56	4	140	1N732	1756	56	15	88	10756	56	150	9	1N1369	
.25762	62	2	170	1N733	1762	62	5	105	10762	62	50	12	1N1370	
.25768	68	2	200	1N734	1768	68	5	125	10768	68	50	14	1N1371	
.25775	75	2	240	1N735	1775	75	5	150	10775	75	50	20	1N1372	
.25782	82	2	280	1N736	1782	82	5	175	10782	82	50	22	1N1373	
.25791	91	1	340	1N737	1791	91	5	220	10791	91	50	35	1N1374	
.257100	100	1	400	1N738	17100	100	5	260	107100	100	50	40	1N1375	

NOTES: Standard tolerance is ± 10% however, closer or wider tolerances are available on request.
Also available on request:
(a) Special voltage ratings.
(b) Symmetrical double anode types (for clippers).



Write for your free copy of the new 6-page Tarzian voltage regulator catalog. It contains helpful design and test information and application notes.

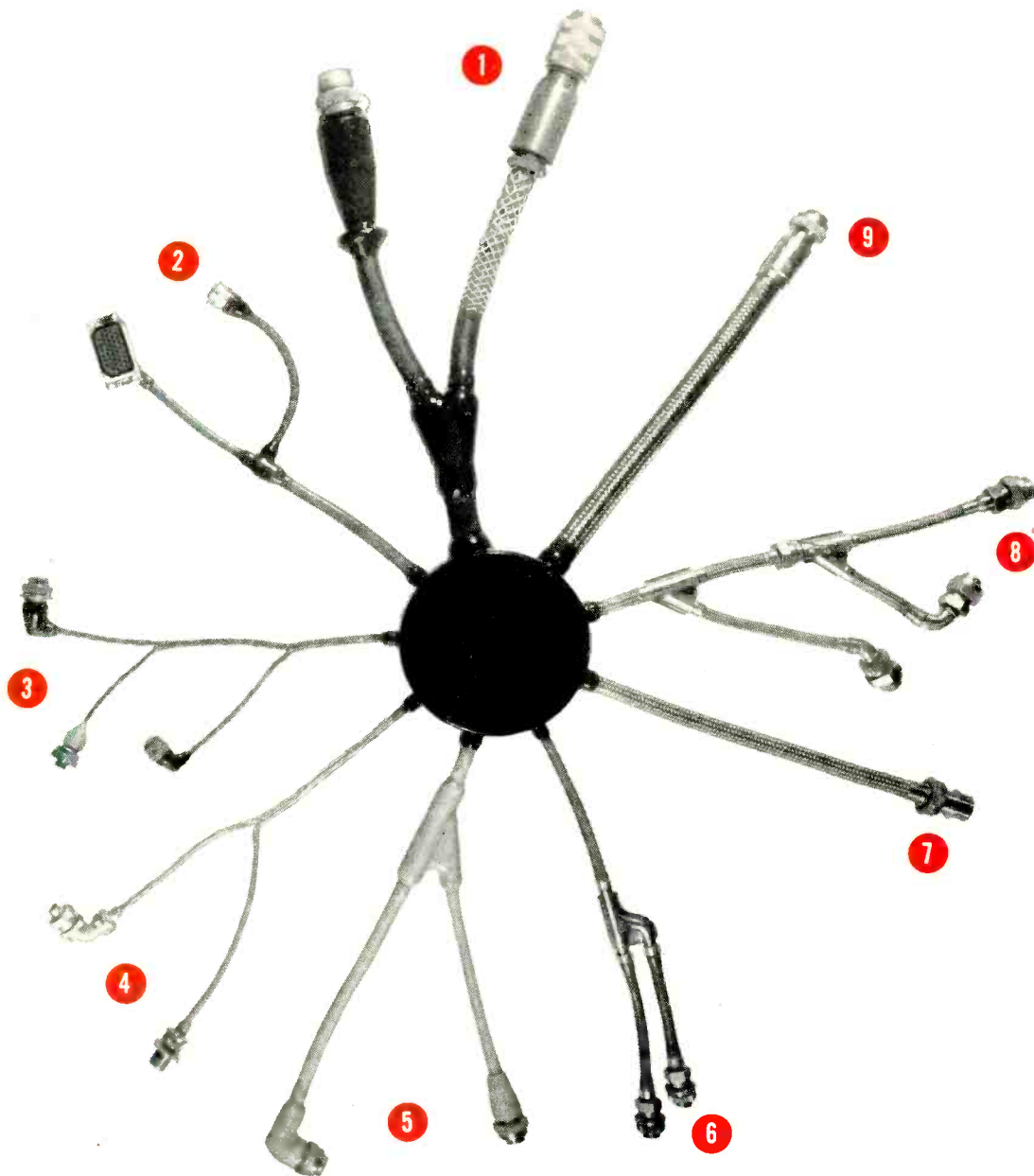

TYPICAL BENDIX® SPECIAL-PURPOSE CABLES THAT SOLVE CRITICAL ENVIRONMENTAL PROBLEMS

- 1 Heavy Duty—Ground Support Cable
- 2 Benseal® Missile Control Cable
- 3 Fabric Braided—Aircraft and Missile Control Cable
- 4 Metal Braid—Aircraft Nacelle Cable
- 5 High Temperature—Radiation Resistant Cable
- 6 High Temperature—Lightweight—Missile Cable
- 7 "Wet Wing" Aircraft Fuel Cell Cable
- 8 Rewirable—Jet Engine Control Cable
- 9 High Temperature—1500°F.—Thermocouple Cable

Bendix cables—products of over a quarter-century of design and manufacturing experience—are proving their complete reliability in a countless variety of applications involving critical environmental conditions.

BENDIX CABLES • BENDIX CONNECTORS

Designed together to work best together

For complete information, write:

Scintilla Division
SIDNEY, NEW YORK



3 in 1

- SELECTIVE ERASURE • WRITE-THROUGH
- DARK TRACE DISPLAY

NOW POSSIBLE IN ONE TUBE. ONLY WITH THE ALL-NEW HUGHES BIC* DIRECT-VIEW STORAGE TUBE!

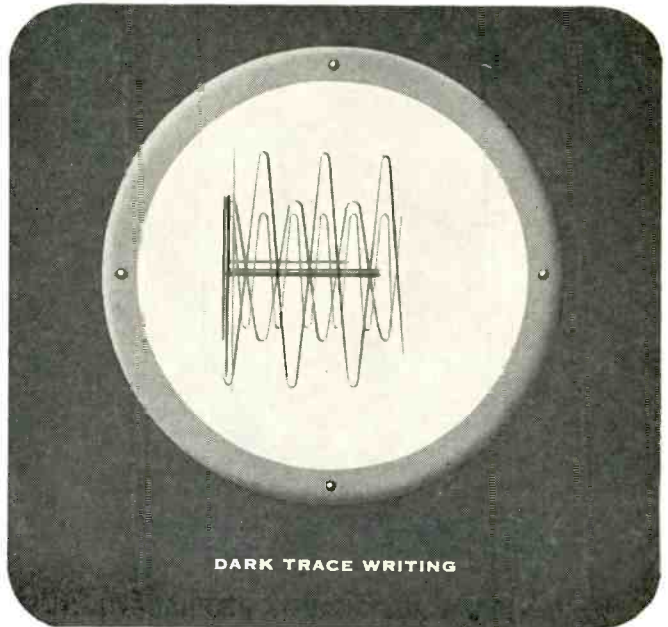
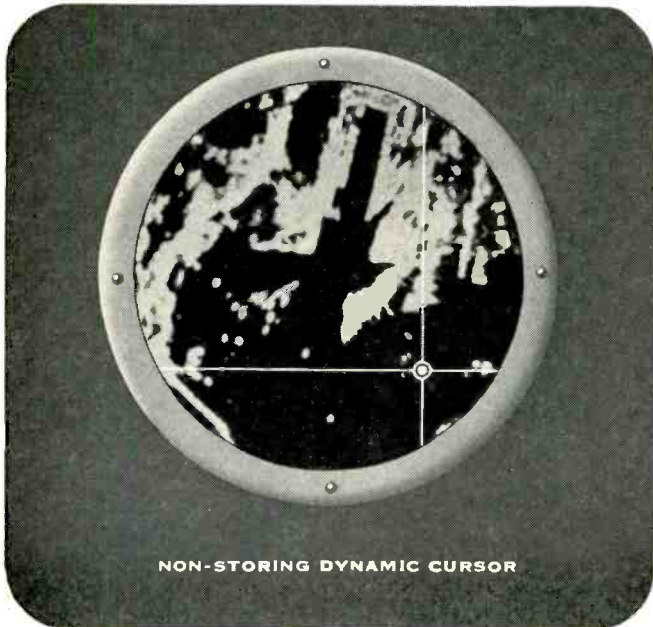

With this unique Hughes BIC* Storage Tube you can now:

- Maintain continuous optimum display brightness
- Present dynamic cursors on stored displays
- Produce dark trace line or half-tone images
- Selectively eliminate screen clutter
- Obtain much higher resolution on all displays

The new Hughes BIC* Storage Tube retains all of the characteristics of the TONOTRON** storage tube — controllable persistence, high picture brightness, full half-tone (grey) scale — and gives you the *added advantages* of selective erasure, simultaneous presentation of stored and non-stored information and high resolution dark trace writing.

For full information on the new Hughes BIC* Storage Tube, write or wire *today*: HUGHES, Vacuum Tube Products Division, 2020 Short Street, Oceanside, Calif. For export information, write: Hughes International, Culver City, California.

* Bombardment Induced Conductivity ** Trademark Hughes Aircraft Company



Creating a new world with ELECTRONICS

HUGHES

HUGHES AIRCRAFT COMPANY
VACUUM TUBE PRODUCTS DIVISION

new

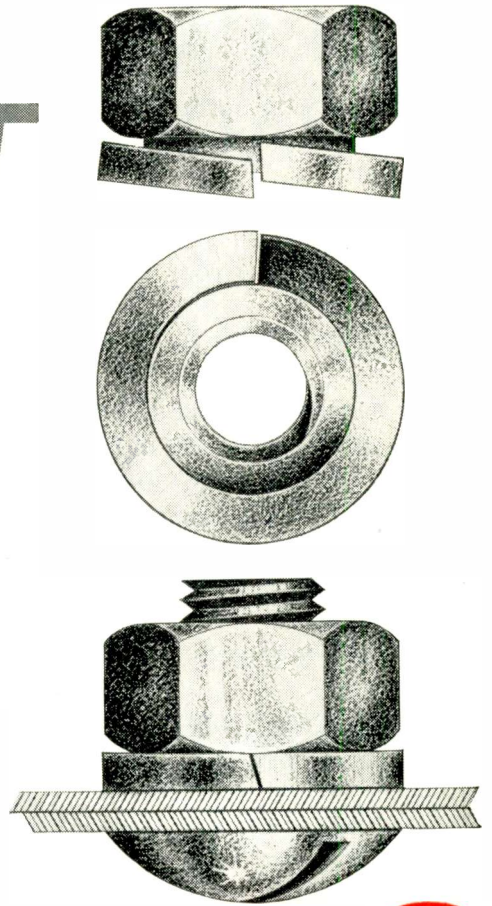

EATON-RELIANCE

FASTITE NUTS

Here is the answer to the growing need by designers and production men for more efficient fasteners on bolted assemblies. The Fastite assembly is a combination nut and helical spring washer, permanently held together, but free to rotate when pressure is applied.

Although it can be applied with equal or better speed than similar fasteners, the biggest advantage of the Fastite nut is the incorporation of the helical spring washer which provides a much greater reactive range and tension than other types of washers now being used.

Of three fasteners tested, the comparative release curve analysis showed the Fastite nut exerted 100 pounds more reactive spring tension when tight than either of the other two fasteners. More interesting, however, from the viewpoint of assembly problems is that the other fasteners lost all reactive spring tension when backed off to .016 inches whereas the Fastite nut still registered 150 pounds. In fact, the Fastite nut still showed reactive tension at .070 inches. The comparative curves are shown at left. A detailed graph of these curves is available for your inspection in the Engineering Bulletin offered below.

Translated into terms of product quality, this simply means the Eaton-Reliance Fastite nut is the best fastener available to reduce the incidence of failure in bolted components due to the ever present problems of bolt stretch and thread wear. Specify Eaton-Reliance Fastite nuts on your next order.

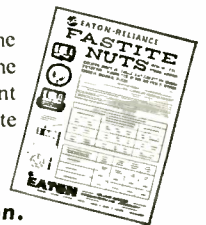
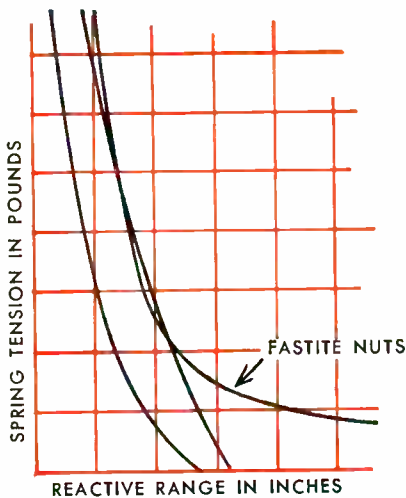

Send for Fastite Nuts Engineering Bulletin, no obligation.



EATON

RELIANCE DIVISION
MANUFACTURING COMPANY
 505 CHARLES AVENUE • MASSILLON, OHIO

SALES OFFICES: New York • Cleveland • Detroit • Chicago • St. Louis • San Francisco • Los Angeles

YOU CAN CRAM A LOT OF STABLE CAPACITANCE INTO A WAFER

Uuf for uuf, the smallest, most stable capacitors you can get for printed circuits and high reliability components. Never has so much capacitance been crammed into so little space with so much ruggedness and reliability.

The smallest gives from 1 to 560 uuf while resting in a space only 0.00204 cubic inch in volume.

The largest runs from 4301 to 10,000 uuf and takes up only 0.02106 cubic inch.

You sacrifice nothing for size. The flat shape gives you more options in mounting, e.g., slot or flat mounting in printed circuits.

When you need leads we can provide those too, in

$\frac{3}{16}$ -inch lengths, in the WL series.

These capacitors are rugged and reliable. The dielectric and conductor layers are fused at high temperatures and need no encasement. You'd almost have to smash one completely to stop its operation. Meets or exceeds the performance requirements of MIL-C-11272B.

For complete specs, write for a new 4-page bulletin to Corning Glass Works, Dept. 546, Bradford, Pa.

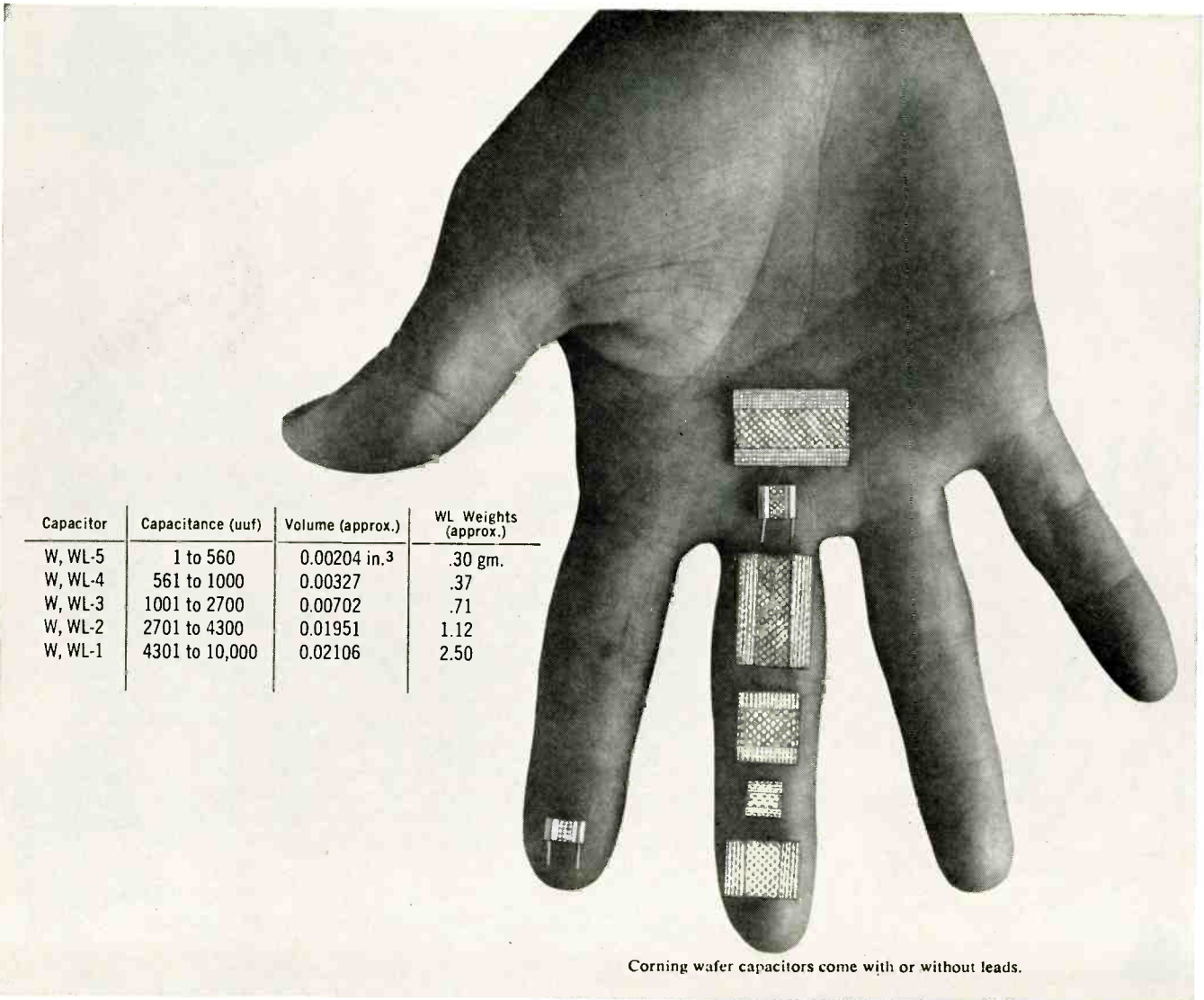

Corning wafer capacitors come with or without leads.

Capacitor	Capacitance (uuf)	Volume (approx.)	WL Weights (approx.)
W, WL-5	1 to 560	0.00204 in. ³	.30 gm.
W, WL-4	561 to 1000	0.00327	.37
W, WL-3	1001 to 2700	0.00702	.71
W, WL-2	2701 to 4300	0.01951	1.12
W, WL-1	4301 to 10,000	0.02106	2.50



CORNING ELECTRONIC COMPONENTS

CORNING GLASS WORKS, BRADFORD, PA.



Snaps in - Stays in

There's muscle in that Deutsch snap-in contact...enough to withstand 25 pounds pull. Each pin and socket in the DS miniature electrical connector is locked in place by a patented spring mechanism that can only be released by specially designed tools. Add to this a crimp that is strong as AN #18 wire itself, and you have the completely reliable DS snap-in type connector. What's more... crimping, inserting, and removing contacts is a quick and easy operation with Deutsch designed tools...even in the hands of unskilled operators. The DS series also features the Deutsch ball-lock coupling mechanism which operates in the direction of plug travel...just push to connect and pull to disconnect. With environmental performance that meets or exceeds MIL-C-26482, plus a wide range of shell sizes and contact arrangements, this connector will satisfy your toughest design requirements with ease.*

DEUTSCH

Electronic Components Division • Municipal Airport • Banning, California

ADVANCED SPECIFICATION MINIATURE ELECTRICAL CONNECTORS

***For complete information contact your Deutschman or write for Data File A-2.**

WITH AN ITT LARGE SCREEN OSCILLOSCOPE

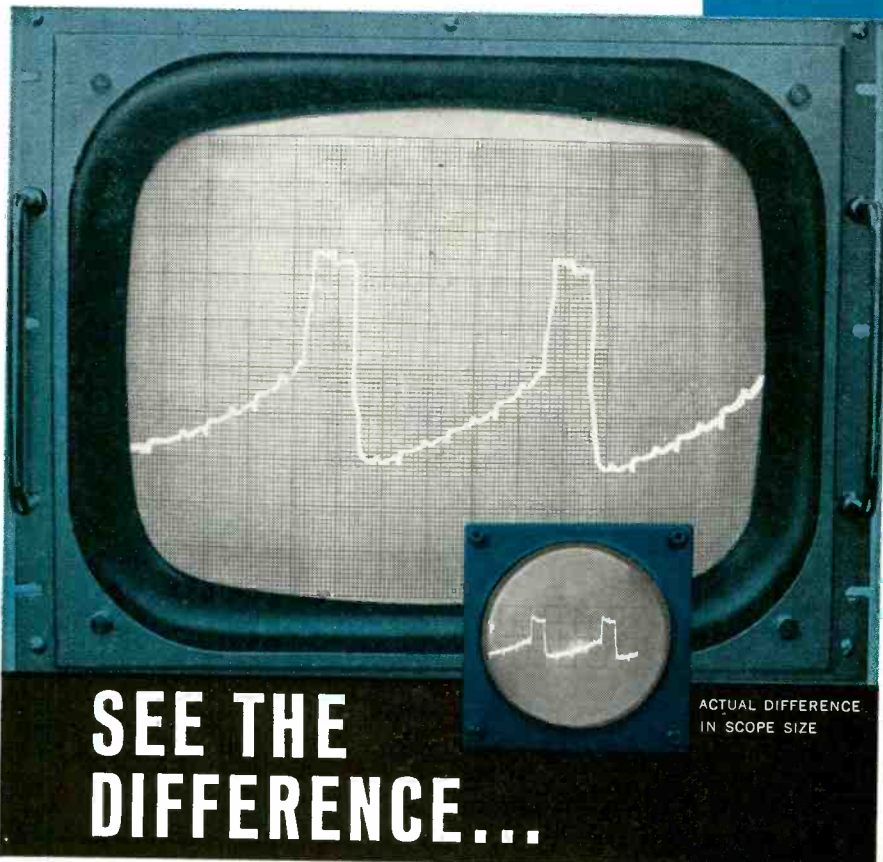

SEE THE DIFFERENCE...

• in *picture size* that presents so much more information • in *accuracy* that allows you to observe even minute details • in *reading ease* that eliminates operator errors and fatigue.

These are some of the differences you see with ITT large scope viewing—advantages you don't get with conventional scopes.

In both 17" rack-mounted and 21" cabinet-mounted units, ITT's precise magnetic deflection system provides excellent resolution and linearity for a wide variety of applications...for teaching, demonstration or exhibition...for telemetering, production testing, waveform analysis, computer readout, X-Y plotting, data plotting and medical observation...easily adapted for bar graph presentation and monitoring.

Complete application and specification data is available at your ITT Instruments representative or by writing us direct for Data File EI-1045-1.

ITT

Industrial Products Division

International Telephone and Telegraph Corporation
15191 Bledsoe Street • San Fernando, Calif. • EMpire 7-6161

static power conversion • instruments • closed circuit television

Books

(Continued from page 62)

The articles contained in the book are not merely abstracts or highly condensed versions of original manuscripts. Each article was especially written for inclusion in this volume and covers every major aspect of its topic. In addition, the material is presented in such a way as to be easily understood by readers unfamiliar with the subject, yet is sound and comprehensive enough to satisfy the expert.

In addition to their emphasis on the uses of spectra in chemical analysis, the authors cover the contributions of spectroscopy to all the sciences, including physics, biology and medicine, metallurgy, mineralogy, geology, ceramics, agronomy, astronomy, and astrophysics.

Designed to meet the needs of scientists, engineers, teachers, students, manufacturers—in short, everyone who has recourse to spectroscopy, whether in research, study or work—this dependable reference provides a wealth of information in one convenient volume.

The Antenna

By L. Thourel, translated by H. de Laistre Banting. Published 1960 by John Wiley & Sons, Inc., 440 Fourth Ave., New York 16. 407 pages. Price \$12.50.

This book, which is based on a course given at the Ecole Nationale de l'Aviation Civile, is essentially a manual for use in planning an antenna system to specific requirements. It has been written both for engineers and technicians who need an introduction or a precis of information on antenna techniques and, with this in mind, numerous types of antenna have been described. Complicated mathematical arguments have been reduced to a minimum necessary for understanding of this text. This is not to suggest that these calculations are useless, indeed they are indispensable to those who wish to go right down to the basis of a problem, and technical progress in antenna design cannot really be achieved without these mathematics. However, the designer is interested in practical formulae which are frequently difficult to extract from an involved theory. This book, therefore, endeavors to show these clearly while indicating, as concisely as possible, the calculations from which they are derived.

Certain sections of the text are printed in small type and these may be passed over by the reader with limited time to spare. In all cases the

(Continued on page 74)

1940 Crimp* • A-MP-O-LECTRIC • Plasti-Grip • SOLISTRAND • Plasti-Bond • AMP-O-MATIC • Amplifilm • AMP-SULA

1941 TION • COPALUM • Ampli-Bond • DYNA-CRIMP • TERMALUM • FASTON • AMPLIVAR • CERTI-SEAL • PIDG • A

1942 MPOWER • DIAMOND GRIP • AMPORTAPOWER • AMP EDGE • Certi-Crimp* • A-MP-O-LECTRIC • Plasti-Grip •

1943 SOLISTRAND • Plasti-Bond • Amplifilm • A-MP-O-LECTRIC • Plasti-Bond • DYNA-C

1944 RIMP • CERTI-SEAL • AMPORTAP

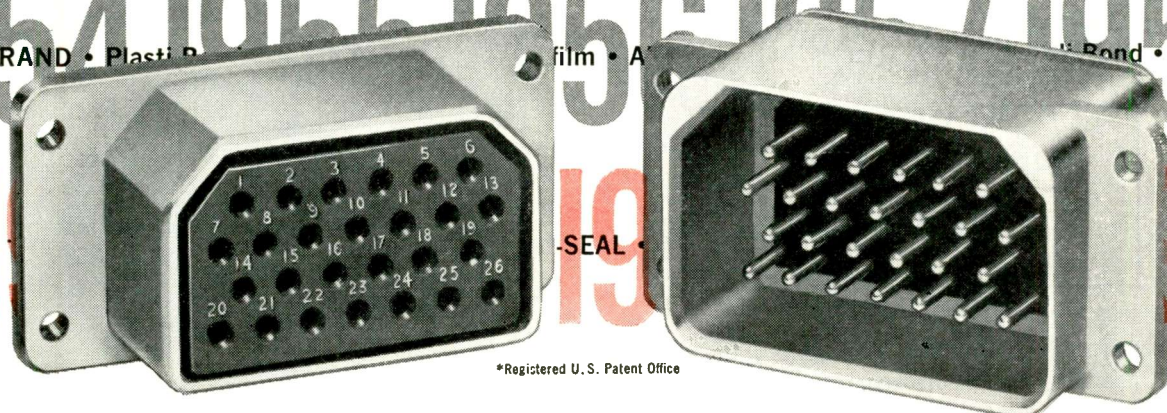

*Registered U.S. Patent Office

INDUSTRY LEADERS...

BECAUSE IT'S THE CRIMP THAT COUNTS!



All connectors may look alike but when faced with the test of performance . . . contact crimp reliability makes them all different. The big difference between other connectors and the AMPin-cert connector is the snap-in design contact attached to the wire by AMP's precision-controlled, compression-crimp technique. Twenty years of intensified research, development and production stand behind the industry-accepted compression technique which produced Solistrand®, Diamond Grip®, Pre-Insulated Diamond Grip®, Plasti-Grip®, Certi-Crimp® and the

more than 15,000 different AMP circuit termination products. This is the common denominator which spells out unquestioned reliability in all our products including the AMPin-cert connector line. ANOTHER AMP FIRST! Now AMP offers tape-fed, automated application of AMPin-cert contacts. Production levels of up to 1,500 terminations per hour can be achieved with standard A-MP-O-LECTRIC® machines. Also, the AMPORTAMATIC crimping tool is available for tape-fed terminations in hard-to-reach locations.

AMP INCORPORATED

GENERAL OFFICES: HARRISBURG, PENNSYLVANIA
 AMP products and engineering assistance are available through subsidiary companies in: Australia • Canada • England • France • Holland • Italy • Japan • Mexico • West Germany

Borg Microdials feature digital readout for increased readability and accuracy



MINIMIZE HUMAN
READING ERRORS

THREE, FOUR and
FIVE-DIGIT MODELS

Borg Direct-Reading Microdials provide faster, more accurate turns-counting readability. They indicate the precise shaft positions of potentiometers or any multiturn device of up to 1,000 turns. Digital readout minimizes human reading errors. The 1330 Series (*above right*) features internal illumination — red light for dark adapted environments or white light. Colors add style to control panels and instruments. Three-digit, ten-turn model with finger-tip brake is standard. All 1330 models display numerals through lenses (1.5x magnification) which are curved for wide-angle viewing. The 1300 Series (*center and bottom right*) is available in three-digit ten-turn, four-digit 100-turn and five-digit thousand-turn models with or without finger-tip brakes. Your nearest Borg technical representative or distributor has complete data.



1330 Series
Three-Digit
Ten Turns



1300 Series
Three-Digit
Ten Turns



1300 Series
Five-Digit
1,000 Turns

CONFIGURATIONS

1300 SERIES				
Model No.*	No. Digits	No. Turns	Brake	Color
1331	3	10		Dark Gray
1332	3	10	X	Light Gray
1333	3	10	X	Red
1334	3	10	X	Black
1335	3	10	X	White

*All models available with or without internal illumination — red light (add suffix LR) or white light (LW).

1300 SERIES				
Model No.	No. Digits	No. Turns	Brake	Color
1309	3	10		Black
1310	3	10	X	Black
1304	4	100		Black
1314	4	100		Black
1305	5	1,000	X	Black
1315	5	1,000		Black
			X	Black

BORG EQUIPMENT DIVISION

Amphenol-Borg Electronics Corporation
Janesville, Wisconsin • Phone Pleasant 4-6616

Micropot Potentiometers • Turns-Counting Microdials • Sub-Fractional Horsepower Motors • Frequency and Time Standards

ALL UNITS ACTUAL SIZE



HYREL® FB
DEPOSITED CARBON RESISTORS
ARE UNMATCHED FOR
PERFORMANCE



HYREL® FB DEPOSITED CARBON RESISTORS
 are hermetically sealed in ceramic jackets against moisture
 and vapor ... **safely protected** against mechanical abuse.
 The Hyrel FB series is intended for applications in military, commercial
 and telephone equipment where **long life under high humidity,**
small size, and stability of electrical characteristics are important.

WRITE FOR ENGINEERING BULLETIN 7010B
SPRAGUE ELECTRIC COMPANY
 233 MARSHALL STREET • NORTH ADAMS, MASS.

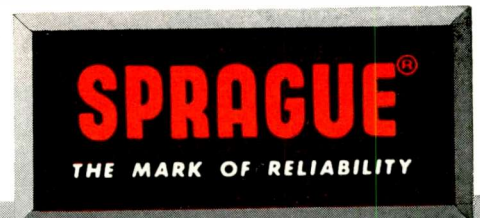

Made to far exceed MIL-R-10509C Specifications

SPRAGUE COMPONENTS:
 CAPACITORS • RESISTORS • MAGNETIC COMPONENTS • TRANSISTORS • INTERFERENCE FILTERS • PULSE NETWORKS
 HIGH TEMPERATURE MAGNET WIRE • CERAMIC-BASE PRINTED NETWORKS • PACKAGED COMPONENT ASSEMBLIES

AC-DC INSTRUMENT CALIBRATION

to 0.25% Accuracy



Model 829A provides a single package method of maintaining plant-wide instrument accuracy at modest cost.

Full-scale calibration accuracy of 0.25% for both AC and DC meters over ranges from 0.25 millivolt to 2000 volts and 2 microamperes to 20 amperes is provided by this completely self-contained unit. AC calibrations can be performed from 50 to 400 cps., depending on line frequency used, or the Model 829A can be driven by an optional variable frequency power supply (see below).

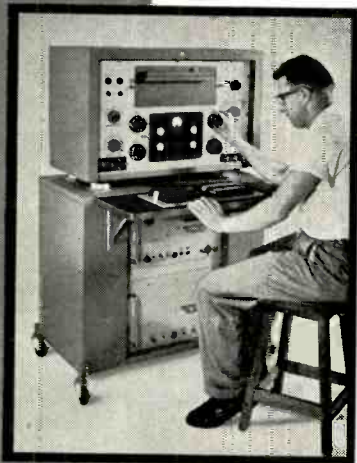

The Model 829A is a comparison type calibrator, using horizontally mounted standard meters of high accuracy and dependability. Range switches and high voltage discharge circuits are safety interlocked, protecting the standard meters and the meter being tested from accidental overloading. Model 829A can be used effectively and safely by personnel not previously acquainted with instrument calibration techniques. Net price \$3,150.

The most compact calibration system available is also mobile.

Photo inset shows the Model 829A secured with shock mounts on the RFL Model 10 Test Equipment Cart with the standard meters recessed into a drop-leaf work shelf. In the Cart is a Model 500 Variable Frequency Power Supply for line regulation and for supplying any frequency for calibration from 50 to 400 cps.

Performance is rigidly guaranteed.
Prices are f.o.b. Boonton, N.J.
and subject to change without notice.



Radio Frequency
LABORATORIES, INC.
Boonton, New Jersey, U. S. A.



SEND
FOR
TECH.
DATA

For additional information, including application data, write or phone DE 4-3100. Demonstrations available by local representatives.

Books

(Continued from page 70)

degree of validity of the formulas and calculations is indicated. The results of the calculations are completed with experimental results and by observations made in the course of setting up installations.

Books Received

Eliminating Man-Made Interference

By Jack Darr. Published 1960 by Howard W. Sams & Co., Inc., 2201 E. 46th St., Indianapolis 6 Ind., 160 pages, paper bound. Price \$2.95.

The Story of Stereo; 1881—

By John Sunier. Published 1960 by Gernsback Library, Inc., 154 W. 14th St., New York 11. 160 pages, paper bound. Price \$2.95.

Solar Cell and Photocell Handbook

By John Sasuga. Published by International Rectifier Corp., El Segundo, Calif. 100 pages. Price \$2.00.

La Modulation de Frequence

By Jean Marcus. Published 1960 by Editions Enrolles, 61 Boulevard Saint-Germain, Paris, France. 317 pages. Price \$45.00 net (prox.)

Governmental Publications

Orders for reports designated (OTS) should be addressed to the Office of Technical Services, U. S. Dept. of Commerce, Washington 25, D. C. Make check or money order payable to: "OTS, Dept. of Commerce." OTS reports may also be ordered through the Dept. of Commerce Field Offices. Prepayment is required. Use complete title and PB number for each report ordered. All other reports may be ordered from the Supt. of Documents, Government Printing Office, Washington 25, D. C.

Symposium on Superconductive Techniques for Computing Systems

By the Office of Naval Research. 418 pages. Price \$4.50.

Technical Resources Directory—Missile Ground Support Equipment, No. 3

By the Office of Director of Defense Research & Engineering. 25 pages. (Rev. 1). Price \$.75.

Handbook Preferred Circuits, Navy Aeronautical Electronic Equipment, NAYWEPS 16-1-519, Supplement No. 3

Dated April 1, 1960. 100 pages. Price \$.55.

Patent and Technical Information Agreements

By the Senate Judiciary Subcommittee on Patents, Trademarks and Copyrights. Patent Study No. 24. Price \$.25.

Expediting Patent Office Procedure—a Legislative History

By the Senate Judiciary Subcommittee on Patents, Trademarks and Copyrights. Patent Study No. 23. Price \$.30.

* * *



How many
of these



**Electronic
Chemicals**

do you need?

Check your requirements against General Chemical's extensive line of B&A® "Electronic Grade" chemicals. Principal products are listed here—and there are many others too! You'll find that "B&A"—America's leading line of "Electronic Grade" chemicals—is your best single source for *all* your high purity chemical needs!

As America's foremost producer of laboratory and custom chemicals, General Chemical has the wide range of products, the versatile production facilities, and the specialized experience to meet virtually every electronic chemical need! Write today for our free information folder, "B&A Electronic Chemicals." Gives specifications plus other valuable information.



GENERAL CHEMICAL DIVISION

40 Rector Street, New York 6, N. Y.

Baker & Adamson® "Electronic Grade" Chemicals

ELECTRONIC INDUSTRIES • February 1961

For Etching

- Acetic Acid—Reagent, A.C.S.
- Ammonium Bifluoride—Technical
- Ammonium Fluoride—Reagent
- Bromine—Reagent, A.C.S.
- Glycerin—Reagent, A.C.S.
- Hydrochloric Acid—Reagent, A.C.S.
- Hydrofluoric Acid—Electronic Grade
- Hydrogen Peroxide (Stab.)—Electronic Grade
- Nitric Acid—Reagent, A.C.S.
- Potassium Hydroxide Pellets and Solution—Electronic Grade
- Sodium Carbonate—Electronic Grade
- Sodium Hydroxide Pellets and Solution—Electronic Grade
- Sulfuric Acid—Reagent, A.C.S.

As Solvents:

- Acetone—Electronic Grade
- Alcohol, Ethyl—Reagent
- Carbon Tetrachloride—Electronic Grade
- Ether—Electronic Grade
- Methyl Alcohol—Electronic Grade
- Propyl Alcohol Iso—Electronic Grade
- Trichloroethylene—Electronic Grade
- Xylene—Reagent, A.C.S.

In the Production of TV Tubes:

- Barium Acetate—Electronic Grade
- Barium Nitrate—Electronic Grade
- Calcium Nitrate—Electronic Grade
- Strontium Nitrate—Reagent, A.C.S.
- Aluminum Nitrate—Electronic Grade

For Semiconductor Production:

- Germanium Dioxide—Electronic Grade
- Germanium Metal—Electronic Grade
- Nickel Chloride—Reagent, A.C.S.
- Nickel Sulfate—Reagent, A.C.S.
- Sodium Hypophosphite—N.F.

For Post Treatment of Semiconductors:

- Hydrogen Peroxide—Electronic Grade

For Capacitors:

- Ammonium Hydroxide—Reagent, A.C.S.
- Boric Acid—Reagent, A.C.S.
- Manganous Nitrate—Reagent, A.C.S.,
Electronic Grade
- Oxalic Acid—Reagent, A.C.S.

For Phosphor Production:

- Zinc Sulfide

For Gaseous Insulation:

- Sulfur Hexafluoride

Circle 70 on Inquiry Card



Bendix Craftsmanship at work for you

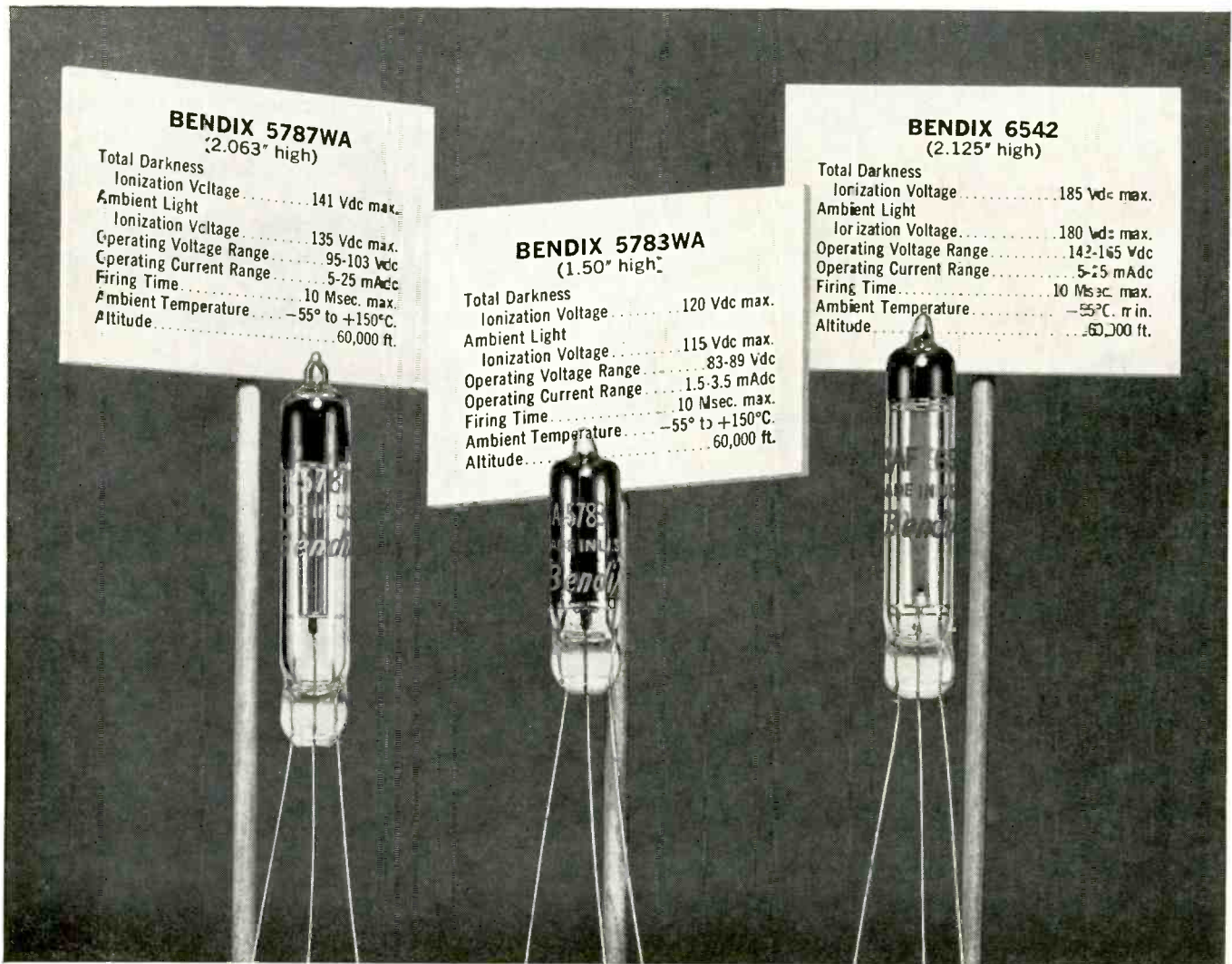

Diodes shown actual size

SUBMINIATURE COLD CATHODE VOLTAGE REGULATOR AND REFERENCE DIODES

provide close, reliable voltage regulation or reference for DC power supply. Bendix® voltage regulator reference tubes are of the gas-filled, cold cathode type. They may be soldered directly into any circuit, and are subminiaturized to save space. They measure only .40" in diameter (heights are shown above). They exhibit very fast start-up times which are independent of ambient light and temperature conditions. They are designed for long life under conditions of severe shock and vibration. Rigid Bendix quality controls, inspection and testing assure utmost reliability. For further information, write . . .

ELECTRON TUBE PRODUCTS

Red Bank Division

EATONTOWN, NEW JERSEY



E-I

Glass-to-Metal SEALS

VERSATILE
RELIABLE
ECONOMICAL

THE DESIGNER'S LINE...

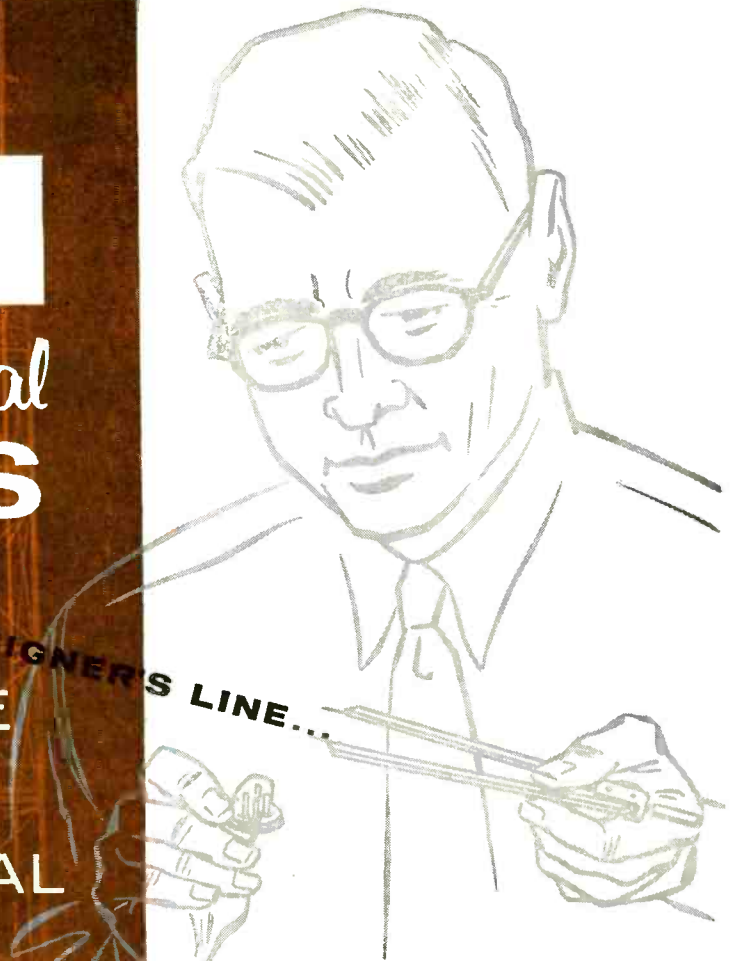

Including semi-conductor seals, individual terminals and multiple headers are available in hundreds of standardized types that reflect the economies of mass production methods. Offer a time and money-saving solution to all but the most unusual sealing problems.

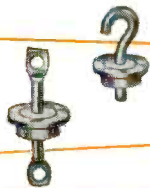

Standard Seals



Special Seals

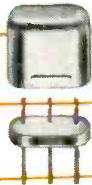
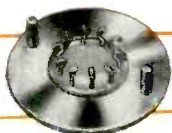

Custom Sealing Service

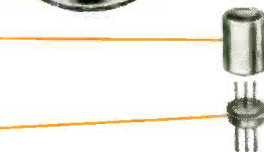

E-I engineers will design "specials" or produce seals to your exact specifications. Custom threaded types, color coding or unusual terminal arrangements can be supplied quickly in reasonable quantities.

Complete facilities available for sealing assemblies of your own manufacture. Please supply sample or drawings for estimates on your sealing requirements, or ask to have a field engineer make recommendations on specific seal applications. Literature on request.

ELECTRICAL INDUSTRIES
MURRAY HILL, NEW JERSEY, U. S. A.

A Division of Philips Electronics and Pharmaceutical Industries Corp.



Patented in Canada, No. 523,390;
in United Kingdom, No. 734,583;
licensed in U.S. under No. 2561520

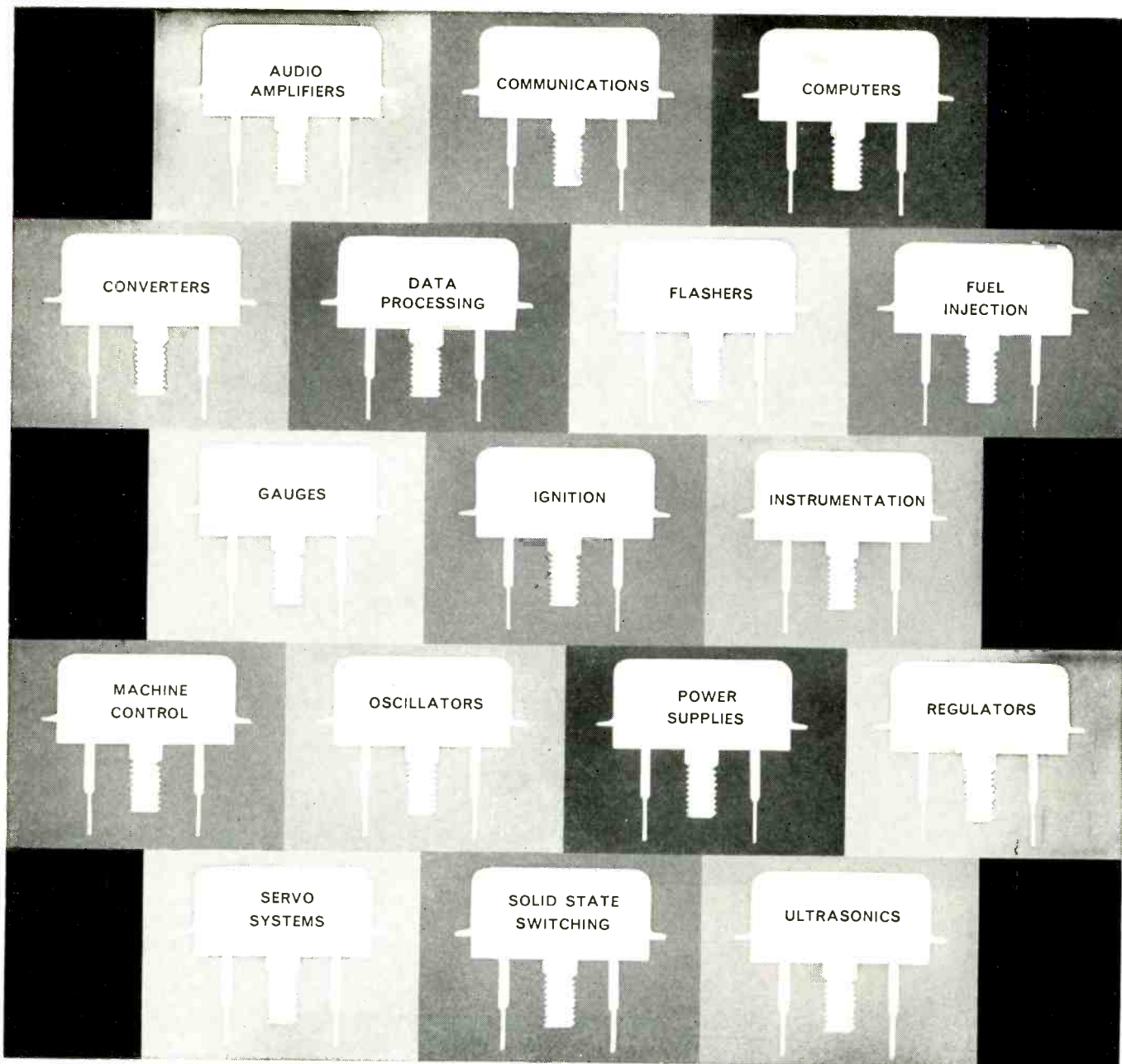

DELCO RADIO — THE LEADER IN POWER TRANSISTORS

For top performance in a wide, wide range of applications, specify Delco Radio's 2N174. ■ This multi-purpose PNP germanium transistor is designed for general use with 28-volt power supplies, and for use with 12-volt power supplies where high reliability is desired despite the presence of voltage transients. ■ It has a high maximum emitter current of 15 amperes, a maximum collector diode rating of 80 volts and a thermal resistance below $.8^{\circ}\text{C}$ per watt. The maximum power dissipation at 71°C mounting base temperature is 30 watts. Low saturation resistance gives high efficiency in switching operations.

■ The 2N174 is versatile, rugged, reliable, stable and low priced. For more details or applications assistance on the 2N174 or other highly reliable Delco transistors, contact your nearest Delco Radio sales office.

Newark, New Jersey
1180 Raymond Blvd.
Mitchell 2-6165

Santa Monica, California
726 Santa Monica Blvd.
Upton 0-8807

Chicago, Illinois
5750 West 51st Street
Portsmouth 7-3500

Detroit, Michigan
57 Harper Avenue
Trinity 3-6560

Division of General Motors • Kokomo, Indiana

DELCO
DEPENDABILITY
RADIO
RELIABILITY

*"Right! You're sure of
reliability with **DALE**
Type WW or HW Resistors"*

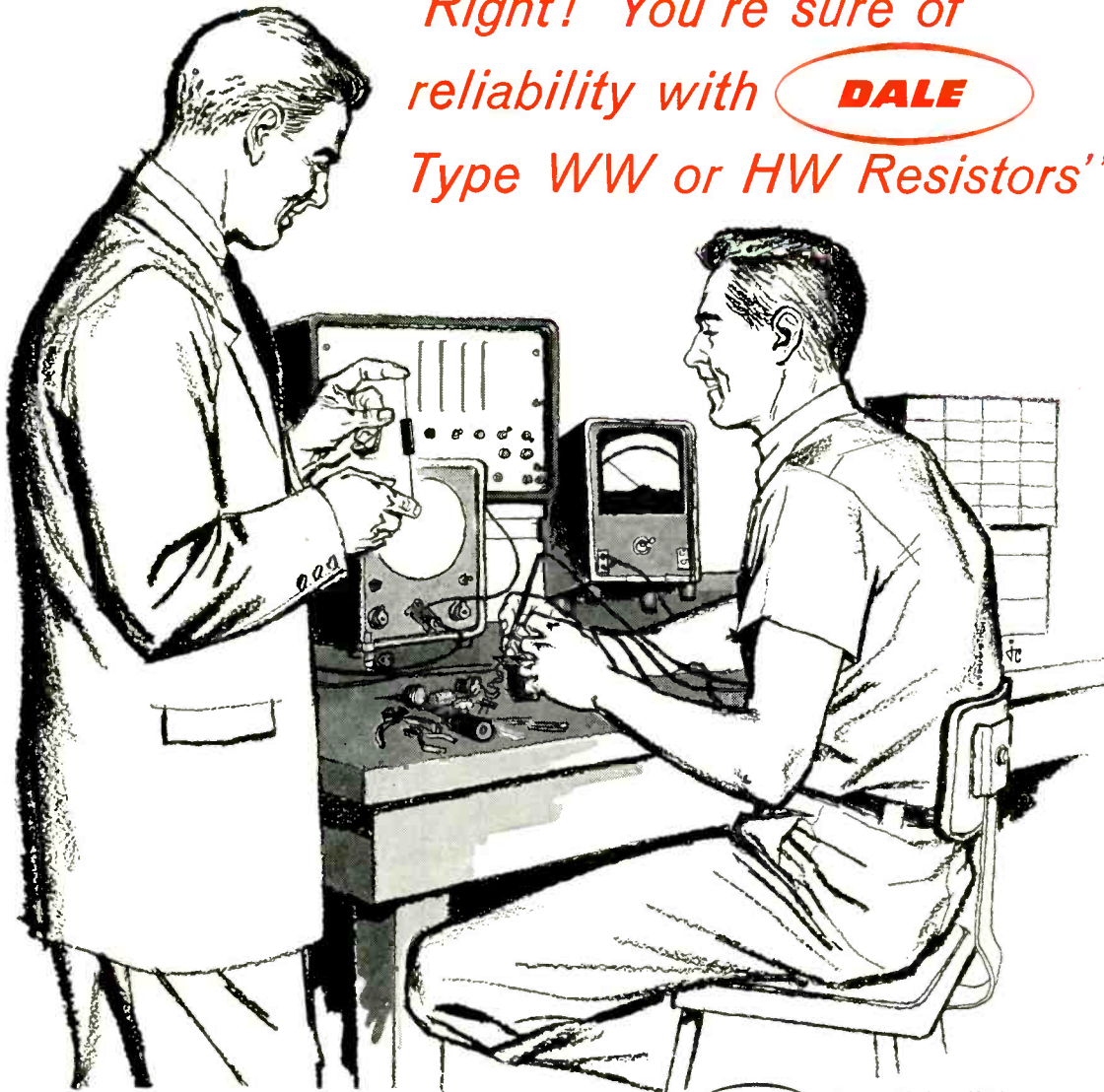

In planning any circuit, even the most advanced, you can check off one question mark the minute you specify Dale precision resistors.

Resistor reliability in that circuit is assured, under any and all conditions, because of Dale's advanced design and methods of manufacture . . . methods which have reached new levels of achievement as part of Dale's super-high reliability development program.

SPECIAL PROBLEMS? Let us help you with your requirements for special resistance products. We make modifications of standard products, resistor networks, matched pairs, etc. Send us your specs.

PROMPT DELIVERY: Whether your need is for a short "test run" or a large production release, Dale offers prompt service, direct from the factory and through a widespread network of distributors.

Write for Bulletin R-26 with handy cross reference file card



DALE ELECTRONICS, INC.

1304 28th Ave., Columbus, Nebraska, U.S.A.

A subsidiary of HATHAWAY INSTRUMENTS, INC.

DALE TYPE WW & HW RESISTORS

WIRE WOUND • BOBBIN • ENCAPSULATED

Dale bobbin type resistors are impervious to salt spray, humidity, moisture and corrosive gases and vapors. The encapsulating material has very high di-electric strength. The resistors have excellent non-inductive characteristics. They are made to surpass functional requirements of MIL-R-93B. (Some sizes and ranges not included in Mil Specs.) WW prefix meets requirements of characteristic A; HW prefix meets requirements of characteristic C.

- RESISTANCE RANGE: 0.1 ohm to 6 meg-ohms, depending on size.
- TOLERANCE: $\pm 0.2\%$; $\pm 0.5\%$; $\pm 0.1\%$; $\pm 0.25\%$; $\pm 0.5\%$; $\pm 1\%$; $\pm 3\%$.
- RATED AT: 0.1 watt to 2.5 watts, depending on size, type and tolerance.
- TEMPERATURE COEFFICIENT: 0.00002 per degree C.
- TERMINALS: WWA and HWA — axial leads; WWP and HWP — parallel leads; WWR and HWR — radial leads; WWL and HWL — lugs.
- SIZES: Complete range from sub-miniature 5/64"x5/16" to 1/2"x2".



Special Instruments

THAT TEST, MEASURE, REGULATE, SIMULATE



... for Regulating Relays,
and Computer Equipment

Current Flow Test Sets simplify the adjustment of single- and double-winding, YP, and polar-type relays and similar electromechanical devices. Accurate, pre-set values for "saturate," "operate," "non-operate," "hold," and "release" currents up to 750 ma can quickly be set up and repeatedly applied in any sequence. *Ask about Shallcross Types 696 and 695.*



... for Testing Welds, Bonds,
Contact Resistance

Portable, wide-range Shallcross Milliohmmeters and Microhmmeters accurately measure low resistances from 0.0001 ohm to 100 ohms on linear scales. By comparing readings against pre-determined standards, defective welds, bonds, and potential failures in heavy conductors can be spotted on a "GO-NO GO" basis. Switch, relay, and circuit breaker contact resistance as well as bar-to-bar commutator resistance can also be measured. *Ask about Shallcross Low Resistance Test Sets.*



... for Measuring Kilovolts

Dozens of standard, Shallcross Kilovoltmeters and Kilovoltmeter Multipliers are available for measuring from 1 to 30 KV. Special Corona-Protected Models measure up to 200 KV. All use stable, close-tolerance Shallcross precision wirewound resistors for long-term accuracy. *Ask for details on Shallcross High Voltage Measuring Apparatus.*

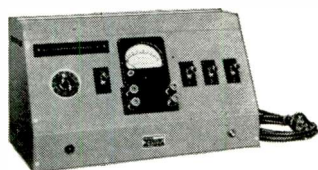

... for Servicing
Communications Systems

For over 25 years, Shallcross has been a key manufacturer of multi-purpose test instruments for telephone and communications system servicing. Types range from portable DB Meters, Tone Generators, and Fault Location Bridges, to elaborate instruments that measure every electrical property and simulate every normal condition usually encountered. *Ask about Shallcross Communications Servicing Instruments.*

Shallcross

OTHER SHALLCROSS PRODUCTS

Decade Resistance Boxes • Decade Voltage Dividers • Kelvin-Wheatstone Bridges
Percent Limit Bridges • Precision Wirewound Resistors • Rotary Instrument Switches
Wheatstone Bridges • Megohm-Wheatstone Bridges • Magnetic Bridges • and
dozens of custom-built instruments for laboratory, production, and field measurements

SHALLCROSS MANUFACTURING CO., 30 Preston St., Selma, N. C.

Personals

Robert M. Flanagan — appointed Chief Engineer, Rotron Manufacturing Co., Inc., Woodstock, N. Y.

Stanley Lehr and Robert E. Othmer —appointed Engineering Section Heads, FXR, Inc., Woodside, N. Y.

Charles R. Fisher—appointed Manager of Product Engineering, Stromberg - Carlson's Telecommunications Div., Rochester, N. Y.

Robert E. Miller—elected to newly created position as Vice President for Advanced Development, Melpar Inc., Falls Church, Va.



R. E. Miller

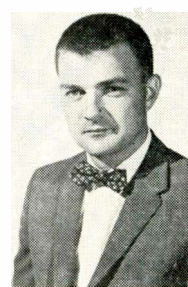

D. L. Nettleton

D. L. Nettleton—named Chief Engineer, Electronic Data Processing Div., Radio Corp. of America, New York, N. Y.

Duncan N. McDonald — appointed Director of Engineering, Electro Data Div., Burroughs Corp., Pasadena, Calif.

Sr. Engineers, George Swetland and Art DeBolt — promoted to Sr. Group Engineers, Electronic Engineering Co. of Calif., Santa Ana, Calif.

J. C. Brandon, Jr.—promoted to Vice President, Engineering, Magnetics Inc., Butler, Pa.

Donald E. Garr—named Corporate Director of Engineering for Raytheon Co., Bedford, Mass.

Otho S. Thompson—appointed to Engineering Management Staff as Manager of Project Engineering, Trimpot Div. of Bourns, Inc., Riverside, Calif.

Martin Rubin—appointed Sr. Staff Engineer of the Data Systems Laboratory, Litton Systems, Inc., Beverly Hills, Calif.

Neville W. James—joins International Resistance Co., Phila., Pa., as Reliability-Quality Control Engineer, a newly created position.

(Continued on page 86)

In **POWER RESISTORS**

if it's news, expect it first from IRC

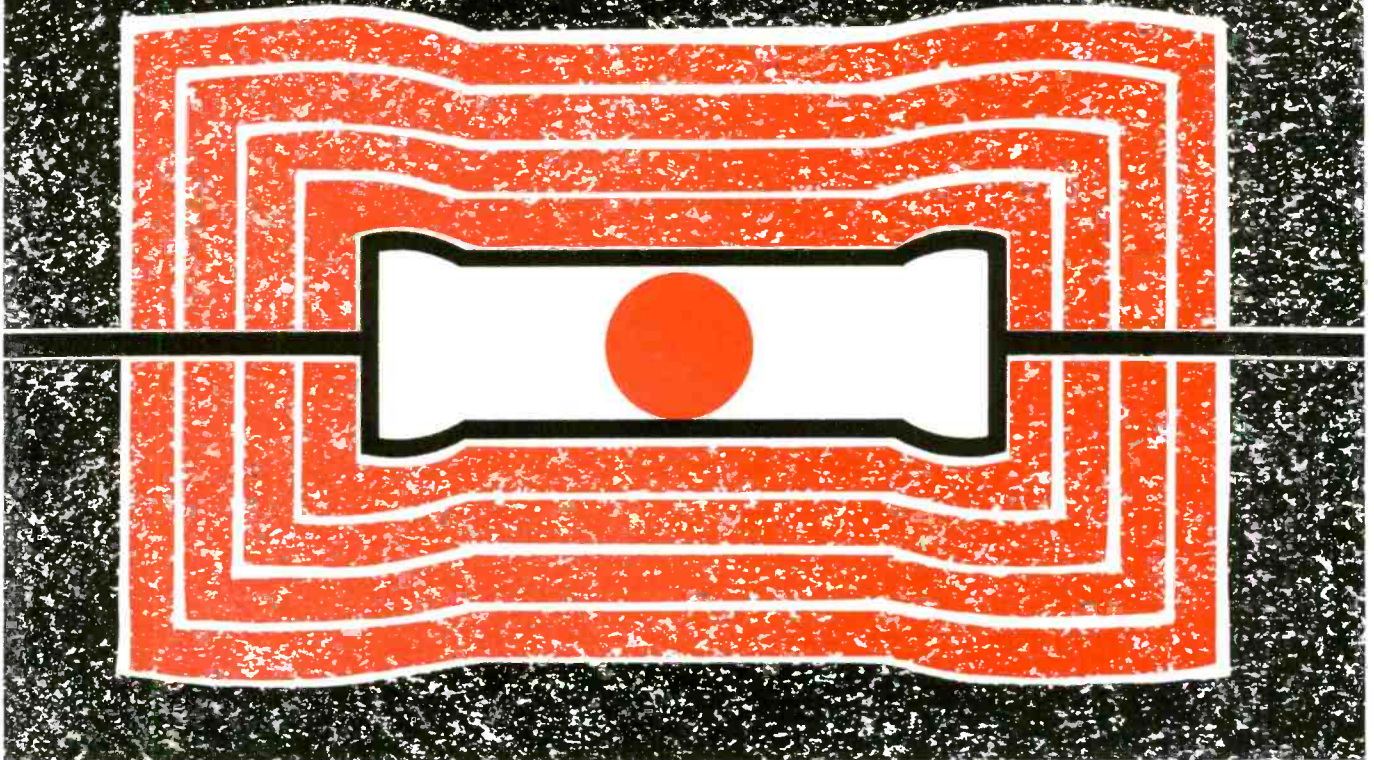

350° Hot Spot—125° Ambient New Precision Power Resistors

A new high-temperature coating—Thermacoat—developed by IRC is responsible for the outstanding performance of IRC miniature power wire wound resistors.

These resistors meet MIL Characteristic V with a hot spot temperature of 350°C, well above the 250-275° customary for resistors of this type.

Thermacoat Resistors have all the other advantages you want—small size, close tolerance, high moisture resistance, high dielectric strength, all-welded construction, high temperature tinned leads and permanent marking. And they're available at a 125° Ambient in the same wattage ratings as regular power wire wound ratings!

Write for Bulletin AE-18, International Resistance Company, 401 N. Broad St., Philadelphia 8, Pa.



Ratings: 2, 3, 5, 7, 10 watts (125° ambient)

Standard tolerances: 1%, 3%, 5% (MIL); Special Tolerances to .05%, depending on range

Resistance ranges: Minimum 0.1 ohm; Maximum 20K to 175K ohms

Dielectric Strength: 1000V-RMS Min.

Non-inductive resistors available



Leading supplier to manufacturers of electronic equipment



You can do MORE with the
NEW TEKTRONIX C-12 CAMERA
than you can with any other
Oscilloscope Camera

... picture this

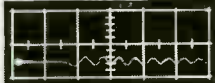

1 KMC damped oscillation
(single shot at 2 nsec/cm).

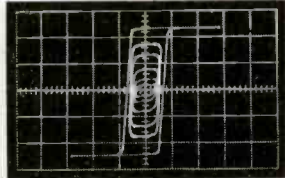

Typical hysteresis loops (multiple
exposure of varying amplitudes).

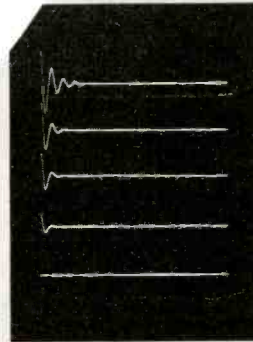

Damped sine wave (multiple ex-
posure using all 5 detent
positions).

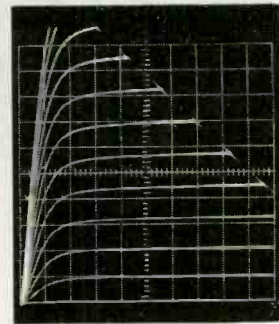

Family of characteristic curves
(for NPN transistor).

... like this

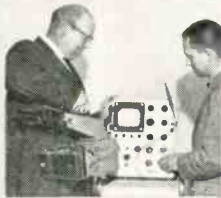

One-hand portability



Lift-on mounting

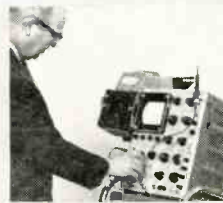

Swing-away hinging



Comfortable viewing—
with or without glasses

... only with this C-12 CAMERA

The C-12 Camera combines flexibility with simplicity. It offers you new convenience in undistorted viewing and direct recording of oscilloscope traces.

Here's why:

You can use Polaroid* or any conventional film.

You can use the unique sliding back, adjustable to horizontal or vertical. On this sliding back, you can interchange the par-focal, film-holding backs, lock them securely in 5 detent positions, also rotate them thru 90° increments (with the long axis of the film horizontal or vertical).

You can choose from 8 easily-interchangeable lenses — in varying object-to-image ratios and maximum aperture to f/1.5. The lenses are housed in uniform, pre-focused, calibrated mounts with keyed threads — so the shutter-speed and diaphragm-opening controls always appear at the same accessible position on the camera.

C-12 CAMERA \$500

Includes: f/1.9 Lens (with 1:0.9 object-to-image ratio) complete with cable release, Focusing Back, Polaroid Back, and Minute Timer.*

*Registered by Polaroid Corporation.



For more information about these and other features of the new C-12 Camera . . . and the many accessories designed for specialized applications . . . call your Tektronix Field Engineer.

Tektronix, Inc.

P. O. Box 500 • Beaverton, Oregon
Phone Mitchell 4-0161 • TWX—BEAV 311 • Cable: TEKTRONIX

TEKTRONIX FIELD OFFICES: Albuquerque, N. Mex. • Atlanta, Ga. • Baltimore (Towson, Md.) • Boston (Lexington, Mass.) • Buffalo, N.Y. • Chicago (Park Ridge, Ill.) • Cleveland, Ohio • Dallas, Texas • Dayton, Ohio • Denver, Colo. • Detroit (Lathrup Village, Mich.) • Endicott (Endwell, N.Y.) • Greensboro, N.C. • Houston, Texas • Indianapolis, Ind. • Kansas City (Mission, Kan.) • Los Angeles Area (East Los Angeles, Calif. Encino, Calif. • West Los Angeles, Calif.) • Minneapolis, Minn. • New York City Area (Albany, N.Y. • Stamford, Conn. • Union, N.J.) • Orlando, Fla. • Philadelphia, Pa. • Phoenix (Scottsdale, Ariz.) • Poughkeepsie, N.Y. • San Diego, Calif. • San Francisco (Palo Alto, Calif.) • St. Petersburg, Fla. • Syracuse, N.Y. • Toronto (Willowdale, Ont.) • Canada • Washington, D.C. (Arlington, Va.)

TEKTRONIX ENGINEERING REPRESENTATIVES: Hawthorne Electronics, Portland, Oregon • Seattle, Washington. Tektronix is represented in twenty overseas countries by qualified engineering organizations. In Europe please write Tektronix Inc., Victoria Ave., St. Sampsons, Guernsey C.I., for the address of the Tektronix Representative in your country.

Precision made to meet
precision standards
of the electronic age!

Little Diamond

DIAMALLOY

Electronic Pliers

Stay snug in the joints, true on the points,
sharp on cutting edges in long contiguous service
... Sold only through regular trade channels. Ask your
electrical or mill supplies wholesaler or write to
manufacturer for a Diamond Tool catalog.
"There is nothing finer than a DIAMOND"

DIAMOND TOOL
and Horseshoe Co.

DULUTH
MINNESOTA



TORONTO
ONTARIO

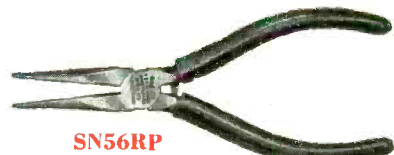

SN56RP



S56



S55R



S54RC



DB58



EC54



LN54



CN54



SN54



DN54



MS54



ST55



LC56



Circle 77 on Inquiry Card



SCOTCH® BRAND MAGNETIC INSTRUMENTATION TAPES OFFER A RIGHT TAPE FOR EVERY APPLICATION

Knowledgeable tape users realize that magnetic tapes are not all alike—that it takes specific constructions to meet the needs of specific applications. And they've learned to rely on "SCOTCH" BRAND to supply the one right tape for each application. Not only does "SCOTCH" BRAND offer a complete line, it offers that something extra that makes all the difference in performance—the uniformity and reliability that result from 3M's experience, technical skill, and continuing research. Make the "SCOTCH" BRAND label your guide in buying instrumentation tapes. Your 3M Representative is close at hand in all major cities—a convenient source of supply and information. For details, consult him or write Magnetic Products Division, 3M Co., St. Paul 6, Minnesota.

© 1961, 3M Company

The wide "SCOTCH" BRAND line provides many tapes, including these broad classifications:

SANDWICH TAPES 188 and 189—exclusive with "SCOTCH" BRAND, offering 10 times the wear of standard tapes, drastic reductions in head wear, elimination of oxide rub-off. In standard or extra-play lengths.

HIGH RESOLUTION TAPES 158 and 159—offering superior resolution in high frequencies, greater pulse density in digital recording. In standard and extra-play lengths.

HEAVY DUTY TAPES 198 and 199—offering exceptional life, good resolution, high resistance to temperature and humidity, reduction in the build-up of static charge. In standard and extra-play lengths.

HIGH OUTPUT TAPE 128—offering top output in low frequencies. Performs well even in temperature extremes.

STANDARD TAPES 108 and 109—offering the good all-round performance at low relative cost which has made them the standards of the instrumentation field.

MINNESOTA MINING AND MANUFACTURING COMPANY
... WHERE RESEARCH IS THE KEY TO TOMORROW



"SCOTCH" BRAND MAGNETIC TAPES FOR INSTRUMENTATION

"SCOTCH" and the Plaid Design are registered trademarks of 3M Company, St. Paul 6, Minnesota. Export: 99 Park Avenue, New York, N.Y. In Canada: London, Ontario.

No, it's not a transistor...



... it's the new Spectrol ultraminature trimmer... the smallest trimming potentiometer on the market! Measuring 1/3" in diameter, weighing only 1 gram, and designed specifically for transistor circuits, the Spectrol Model 80 is a remarkable breakthrough in component technology.

Design engineers can now shrink printed circuit packages in all three dimensions. The single turn adjustment is from the top, rather than the side. It is ideal for printed circuit applications. Sealed construction allows complete package encapsulation.

THE MODEL 80 is approximately one-quarter the size of ordinary trimmers, yet it offers greater resolution and resettability because the resistance element is nearly twice as long. These trimmers meet all applicable military and commercial specifications including the most severe humidity cycling and immersion tests.

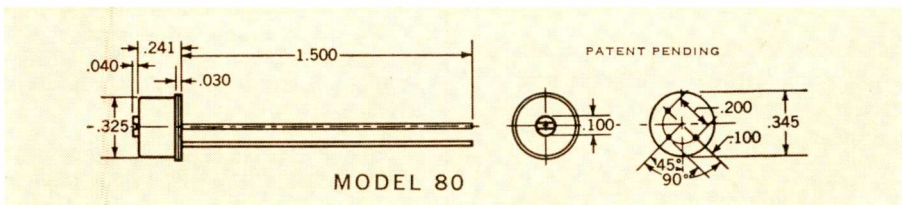

Available now for immediate delivery. Standard models of Spectrol trimmers and miniature potentiometers, as well as other standard precision potentiometers, are available from your nearby Spectrol distributor. For complete technical information, contact your Spectrol engineering representative or write directly to the factory. Please address Dept. 44.

SPECIFICATIONS

DIAMETER 0.345"
 STANDARD RESISTANCES (ohms) 50, 100, 200, 500, 1K, 2K, 5K, 10K
 RESISTANCE TOLERANCE $\pm 5\%$
 NO. TURNS ONE
 POWER RATING 1 watt at 70°C
 LINEARITY $\pm 1.0\%$
 NOISE 100ΩENR per NAS-710
 SHOCK 50 G
 VIBRATION 30 G to 2,000 CPS
 HUMIDITY MIL-E-5272C, Proc. I (10 days, cycling) and MIL-STD-202A, Method 104, Condition A (immersion in hot water)
 SALT SPRAY MIL-STD-202A, Method 101A, Condition A (96 hours)
 LOAD LIFE 1000 hours
 WEIGHT 1 Gram
 PRICE (1-9 units) \$6.00 each

The Spectrol name,
 your assurance of quality.

Spectrol trimmers are produced to the same exacting standards of quality and reliability engineered into the entire Spectrol potentiometer line... the largest selection in the industry.



30

ELECTRONICS CORPORATION

1704 South Del Mar Avenue • San Gabriel, California
 Phone: ATLantic 7-9761
 1250 Shames Drive • Westbury, L. I., New York
 Phone: EDgewood 3-5850

Another CUSTOM TRANSFORMER FOR INDUSTRY FROM Light Electric

... UNITIZED RECTIFIER



Plate and Filament
Transformer
immersed in oil.

TWO TYPICAL VARIATIONS

3φ Full Wave Bridge Rectifier*

RATINGS	DC OUTPUT	WIDTH	LENGTH	HEIGHT
7.9 KVA	25 KV @ 300 ma	21"	21"	30"
31.2 KVA	17.5 KV @ 1.7 amp	24"	41 1/8"	33"

Other sizes available up to 150 KW DC

*Units ordinarily supplied without tubes.

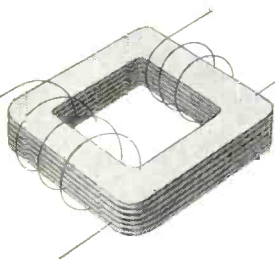

For quotations on this and other custom designs, be sure to specify DC output desired, Isolation required, Space requirements (if any), Input voltage available, frequency and type of rectifier tube.

Light Electric Corp.

219 Lackawanna Avenue, Newark 4, New Jersey
Telephone: HU 5-4110

PLATE TRANSFORMERS
dry or oil immersed
1 to 250 KVA
rectified outputs to
75 KV DC
50, 60, or 400 cps

FILAMENT TRANSFORMERS
low capacitance
high reactance
multiple coil

CHOKES
filter
charging

UNITIZED RECTIFIERS
oil immersed to 100 KVA
rectified outputs to
75 KV DC

UNITIZED CONTROLLED POWER SOURCES

saturable reactor or
amplistat control
capacities to 100 KVA
AC or DC outputs for furnace
or plating applications

LABORATORY EQUIPMENT
high voltage testing
transformers

unit high voltage test sets
reduced corona
transformers for
corona testing

MISCELLANEOUS

audio output transformers
5 cps to 10 kc
5 to 30 KVA
saturable reactors
1 to 100 KVA
amplistat for control of
rectifier output
current limiting reactors
tapped furnace or
annealing transformers

Personals

George Dunn, Jr.—appointed to the post of Senior Development Engineer at R&D Silicon Transistor Corp., Carle Place, N. Y.

Leon Mollick — appointed Manager of Engineering, Industrial Equipment Div., Baldwin-Lima-Hamilton Corp., Phila., Pa.

Harvey E. Rennacker — appointed Sr. Staff Engineer, Bendix Computer Div., Los Angeles, Calif.

Robert L. Wooley — named Manager—Engineering Operation at General Electric Light Military Electronic Dept.'s, Armament & Control Section, Johnson City, N. Y.



R. L. Wooley



T. Law

Dr. J. Trevor Law—named Sr. Engineer, Materials Dept., Motorola, Semiconductor Products Div., Phoenix, Ariz.

J. A. Brustman—appointed Manager, Electronics Systems Engineering, Advanced Systems Development Engineering Activity, RCA Electronic Data Processing Div., N. Y., N. Y.

John Hastings—joins staff of Coga Electronics Corp. as Manager, Special Projects, Van Nuys, Calif.

Edward T. Pfund, Jr.—named Chief Engineer, Technicraft Div., Electronics Specialty Co., Thomaston, Conn.

Palmer M. Craig—appointed Director of Operations of Philco Corp.'s Western Development Laboratories, Palo Alto, Calif.

Allen W. Scott — appointed Assistant Manager of the Research & Development Dept., Hughes Aircraft Co.'s Microwave Tube Div., Los Angeles, Calif.

Dale Dowis — to new position of Chief Application Engineer at IMC Magnetics Corp., Western Div., Maywood, Calif.

Frank C. Ebert—appointed Chief Product Engineer, Allied Control Co., Inc., Plantsville, Conn.

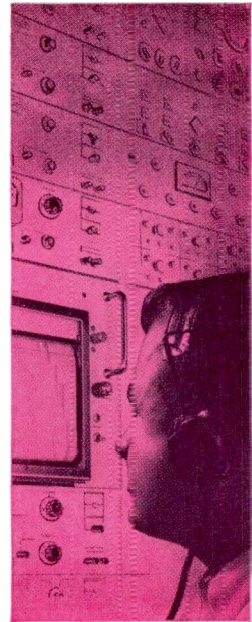
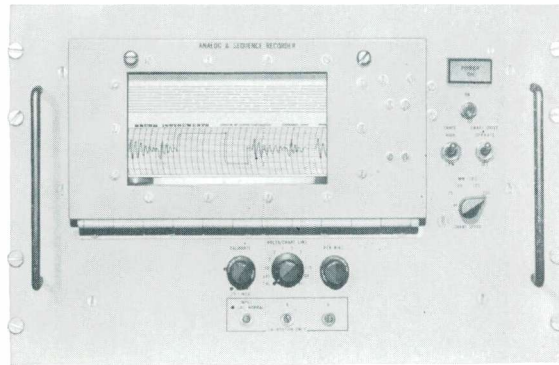
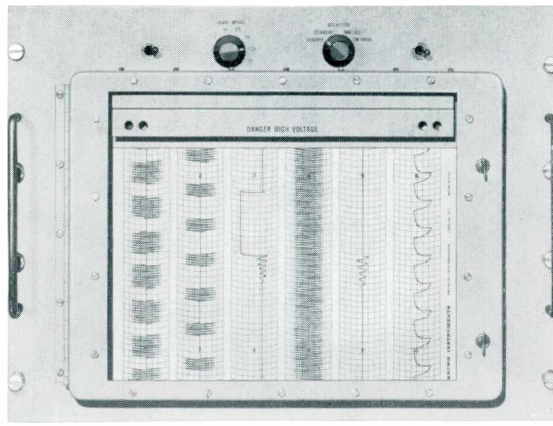

in direct writing recording systems

only **Brush**
designs

specifically for **mil specs**

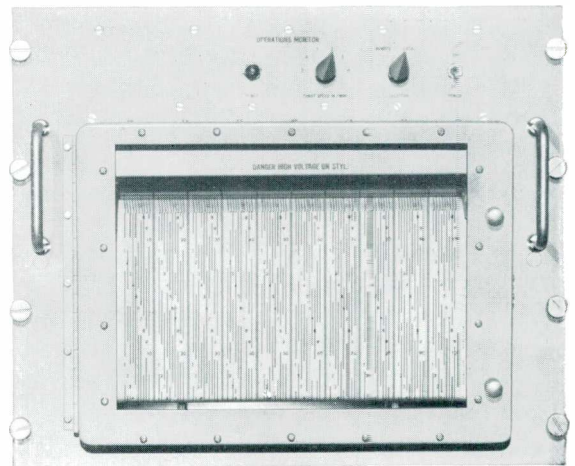

From every nut and bolt to the shipping crate, fully militarized Brush Direct Writing Recording Systems are *originally* built to meet military specifications.

That's why they are performing every imaginable task of data acquisition and recording at U. S. and NATO installations throughout the world. These electric writing systems have proved their unexcelled reliability . . . from the Operations Monitor that will record 120 separate operations at the instant they occur . . . to the Analog and Sequence Recorder that simultaneously records both analog data and sequential events. And, they are built for maximum performance in the hands of non-technical personnel.

Brush equipment is already at work putting evaluation data in writing for a whole new generation of weapons. When the weapons become operational, Brush MIL Recorders are a vital part of the system. This experience is unique in the industry. *Before* prototype design becomes a problem—call, write or wire Brush for complete details.

brush INSTRUMENTS

DIVISION OF

37TH AND PERKINS

CLEVITE
CORPORATION

CLEVELAND 14, OHIO

Now...G-E Unijunction Transistors give you silicon performance at germanium prices

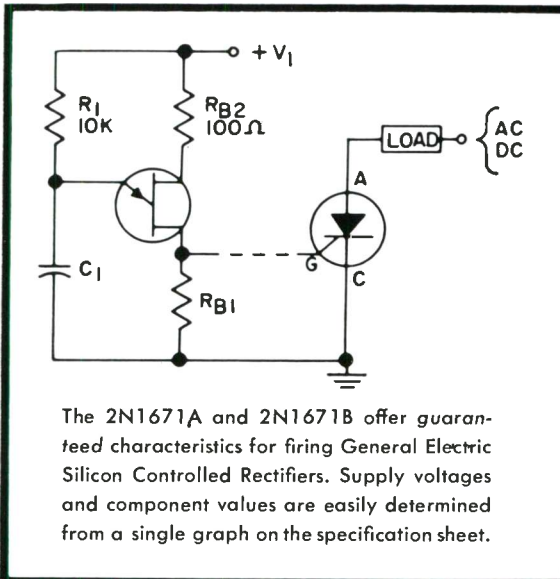

Typical Circuit Comparisons—Because of its unique characteristics, one unijunction transistor can often replace two conventional transistors with significant savings in overall circuit cost. You can simplify circuit requirements and at the same time achieve improved stability over a wide temperature range.

Transistor Time Delay Circuit

3 transistors*
1 diode
1 Zener diode
1 relay
2 capacitors
8 resistors

Unijunction Circuit Equivalent

1 unijunction transistor
1 Zener diode
1 relay
1 capacitor
4 resistors

SAVINGS: \$3.30 (*germanium transistors)
\$16.50 (*silicon transistors)

Transistor Voltage Detector

2 transistors*
1 potentiometer
2 capacitors
5 resistors

Unijunction Circuit Equivalent

1 unijunction transistor
1 potentiometer
1 capacitor
3 resistors

SAVINGS: \$0.40 (*germanium transistors)
\$9.20 (*silicon transistors)

Types 2N1671, 2N1671A, and 2N1671B are the latest additions to the General Electric line of silicon unijunction transistors . . . at a price comparable to germanium transistors. A unique type of semiconductor device proved in over three years of production and application, silicon unijunction transistors feature stable negative resistance characteristics, extremely low trigger currents, stable trigger voltages, and high pulse current capabilities.

The 2N1671 is intended for general purpose industrial applications where circuit economy is the prime consideration. The 2N1671A features a guaranteed minimum pulse amplitude and is characterized for use in firing circuits for Silicon Controlled Rectifiers. The 2N1671B features low emitter leakage current and low trigger current, making it the most sensitive semiconductor triggering device available.

Price reductions have also been made on

standard unijunction types 2N189 through 2N491. For complete technical data and application information for all unijunction transistor types, see your G.E. Semiconductor District Sales Manager. Or write section 24B87, Semiconductor Products Dept., General Electric Company, Electronics Park, Syracuse, New York. In Canada: Canadian General Electric Company, 189 Dufferin Street, Toronto, Ontario. Export: International General Electric Company, 150 E. 42nd St., New York, N. Y.

CONDENSED SPECIFICATIONS OF UNIUNCTION TRANSISTORS 2N1671, A, B

Maximum Total Power Dissipation	450 mw
Operating Temperature Range	-65°C to 140°C
Intrinsic Standoff Ratio (η)	0.47 to 0.62
Interbase Resistance (R_{BB})	4.7K to 9.1K
Peak Point Emitter Current (I_{EP}) ($V_{BB} = 25$ volts)	2N1671A 25 μ a max. 2N1671B 6 μ a max.
Emitter Reverse Current (I_{ER}) ($V_{EB2} = 30$ volts)	2N1671A 12 μ a max. 2N1671B 0.2 μ a max.
Base—One Peak Pulse Voltage	2N1671A,B 3 volts min.
(In SCR circuit shown, $V_1 = 20V$, $C_1 = 0.2 \mu$ fd, $R_{B1} = 20\Omega$)	

For fast delivery at factory-low prices, call your G-E distributor.

Progress Is Our Most Important Product

GENERAL  ELECTRIC

Next month

● INSTRUMENTATION FOR RADIO INTERFERENCE MEASUREMENTS

Another in EI's series on RFI. Interference instrumentation is divided generally into two categories—those for field survey use and those used by researchers for studying detailed properties of the noise. Instruments for both are discussed along with information about commercially available instruments.

● SPECIAL DESIGN CONSIDERATIONS FOR SILICON RECTIFIERS

Mounting cells on your own heat sink, connecting cells in series or parallel creates a series of special design problems. Overload protection devices which must be specified in any application will differ depending on customer requirements. Here's a summary of such design problems with successful solutions.

● THE 1961 IRE INTERNATIONAL CONVENTION

Presenting for this 49th annual event of the Institute of Radio Engineers

- a) Descriptions of new products to be introduced at the show
- b) Comments on technical papers of especial interest
- c) Complete listing of the technical papers program
- d) What 1961 IRE Fellows predict
- e) Exhibitor locator guide

● DESIGN TRENDS IN LOW K SUBSTRATE MODULES

Multi-component assemblies are constructed on high or low dielectric basic materials. Low dielectrics are employed for minimum coupling. In other systems the substrate participates as the dielectric forming various capacitances required by the circuit. A review of the developments from the time of Project Tinkertoy.

● PART V—ELECTRONIC INDUSTRIES HARDWARE CHART SERIES

Continuing with the informative series of hardware charts published in earlier issues, Part V will contain valuable reference data on transistor sockets, high temperature subminiature sockets, pencil tube sockets, Nuvistor and Compactron sockets along with octal, loctal and CRT molded sockets.

Plus all our other regular departments

Our regular editorial departments are designed to provide readers with an up-to-the-minute summary of world wide important electronic events. Don't miss Radarscope, As We Go To Press, Elec-

tronic Shorts, Coming Events, EI Totals, Snapshots of the Electronic Industries, EI International, News, Briefs, Tele-Tips, Books, Representatives News, International Electronic Sources, Personals, etc.

COMING SOON—

● THE 1961 ANNUAL ALL-REFERENCE ISSUE

The fourth consecutive annual edition containing year-round technical reference information for electronic engineers. The editorial staff is already at work compiling and selecting data for this issue. Suggestions from user-readers for new topics and compilations to be included will be given careful consideration.

Watch for these coming issues:

***MARCH**
Annual IRE Issue

***JUNE**
Annual All-Reference &
Directory Issue

***AUGUST**
Annual WESCON Issue

Lack of a self-excited coherent source of millimeter power has led to the design of crystal harmonic generators. Sufficient signal has been obtained for construction and calibration of several components. Novel design and construction techniques are described here which overcome restrictions of TE₁₀ rectangular waveguide.



Designing 2-Millimeter Wave

By LESTER L. BERTAN
*Asst. Chief Microwave Engineer
 FXR, Inc.
 25-26 50th Street
 Woodside 77, New York*

THE impetus provided by the radar developments of World War II extended the microwave frontier from the meter wavelength range to the range of approximately one centimeter. This "backlog" of frequencies resulted—with some notable exceptions, in such fields as microwave spectroscopy—in a slackening of the extension of the microwave spectrum in the years immediately following the war. However, this situation did not long continue.

The ever-increasing demand for additional channels of communications resulted in the investigation of millimeter waves, where bandwidths in the order

to communications has resulted, within the past five years, in the commercial extension of most of the more common microwave components into the RG-98/U, or 4-6 millimeter waveguide size.

Among those areas where millimeter waves prove particularly advantageous are microwave spectroscopy and the analysis of energy gaps in superconductors. They are used there to investigate the fundamental properties of matter. Millimeter waves could also be used as high frequency pumps for parametric amplifiers and masers. High altitude radar and communications are other fields applicable to millimeter waves. Here the lower atmosphere absorption of the waves can be largely ignored, and full use can be made of the narrow beams and high accuracies attainable with short wavelengths. An extension of this application is space communication and telemetry, where extreme accuracies will certainly be required. The advantages to be gained by the use of millimeter waves are obvious when one realizes that a 1 ft. dish at 1 mm. is equivalent in beamwidth to a 100 ft. dish at S-band.

One of the most important applications for millimeter waves is in the study of the highly ionized plasma produced in controlled fusion research. Low level microwave energy can be shot through the plasma without appreciably disturbing the reaction. The propagation characteristics of the plasma at millimeter wave frequencies can be related to such plasma properties as temperature, electron density, and confinement time.² The potential use of microwave diagnostics as a tool for controlled fusion re-

Fig. 1: Simplified equivalent circuit for (a) the non-linear reactor and (b) the non-linear resistor crystal harmonic generators.

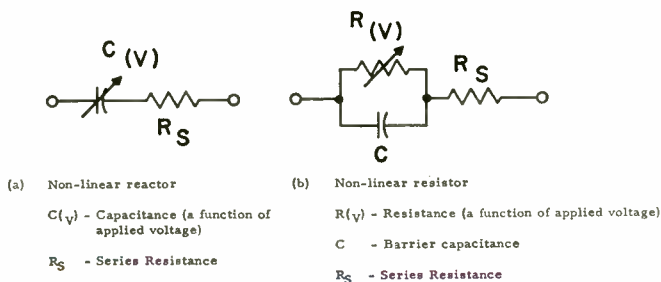

of tens of kilomegacycles could be readily made available. Many components and systems were constructed around RG-98/U waveguide (0.148 in. \times 0.074 in. I. D.) for use in the frequency range 50-75 KMC.¹ The use of this frequency range for purposes in addition

action has resulted in the sponsorship by the Atomic Energy Commission of a program leading to the development of microwave components in the 2 mm. (150 KMC) wavelength region.

Difficulties

The two major obstacles to component development for the shorter millimeter wavelengths have been the lack of a self-excited coherent power source and the high attenuation and close tolerances associated with the TE₁₀ fundamental mode rectangular waveguide.

The small physical size and resultant high current density requirements effectively set an upper frequency limit for the currently known types of microwave tube.^{3, 4} The highest reported fundamental frequency is 200 KMC for a backward wave oscillator.⁵

Components

Commercially available tubes reach only to the vicinity of 4 mm. (75 KMC). Megavolt electronics and other new schemes³ are being investigated as millimeter wave generators. However, none of these has as yet produced a practical coherent CW oscillator. It was, therefore, necessary to look to harmonic generation for the microwave signal required for the development and testing of components in the 2 mm. wavelength region.

Crystal harmonic generation is the most common method used for the generation of low power microwave signals when there are no available prime sources. The two types of crystal harmonic generator are the non-linear reactor and the non-linear resistor. The simplified equivalent circuit of each is shown in Fig. 1.

The ideal non-linear reactor can be shown⁶ to have a theoretical efficiency of 100% when operating in a circuit that has an infinite impedance to all harmonics other than the one desired. The non-linearity usually considered is the Q-V curve of the p-n junction, the capacitance of which is given by⁷

$$C = \frac{C_0}{\sqrt{1 - V/\phi}}$$

where V is the applied voltage and C_0 and ϕ are constants of the junction. Thus, since we can certainly obtain sufficient power at centimeter wavelengths, it would appear that we need only synthesize an appropriate microwave circuit to get the necessary millimeter wave power. Unfortunately, however, the efficiency of the reactive diode falls off rapidly at its cutoff frequency, as determined by the series resistance of the diode, Fig. 1a, is approached. The best presently available diodes have a cutoff frequency in the neighborhood of 100 KMC, which limits their effective use as harmonic generators to the centimeter rather than the millimeter region.

It has been shown that the limiting theoretical efficiency of the ideal resistive diode is⁸

$$\frac{P_n}{P_1} = \frac{1}{n^2}$$

where,

- P_n = the power output at the desired harmonic,
- P_1 = the fundamental frequency power, and
- n = the number of the harmonic. Here again, although the efficiency of a frequency doubler could conceivably be as high as 25%, Fig. 1b indicates the effects of the crystal series resistance and barrier capacitance which result in the considerably lower efficiencies usually experienced.

Several different types of crystal materials were tried as 4 to 2 mm. converters. Welded contact germanium diodes, operating essentially as non-linear resistors, offered the best efficiency. Although it is

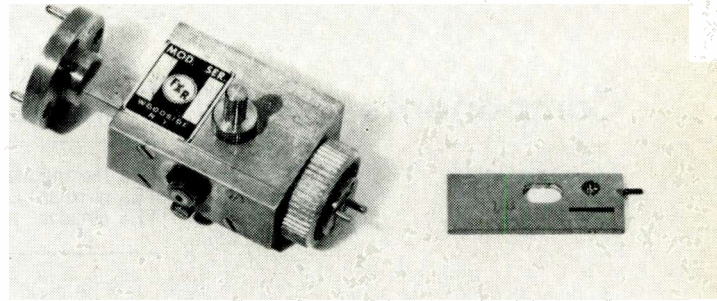

Fig. 2: The harmonic generator mount and 2mm. detector cartridge.

Fig. 3: Transition from the TE₁₀ rectangular to the TE₀₁ circular waveguide mode.

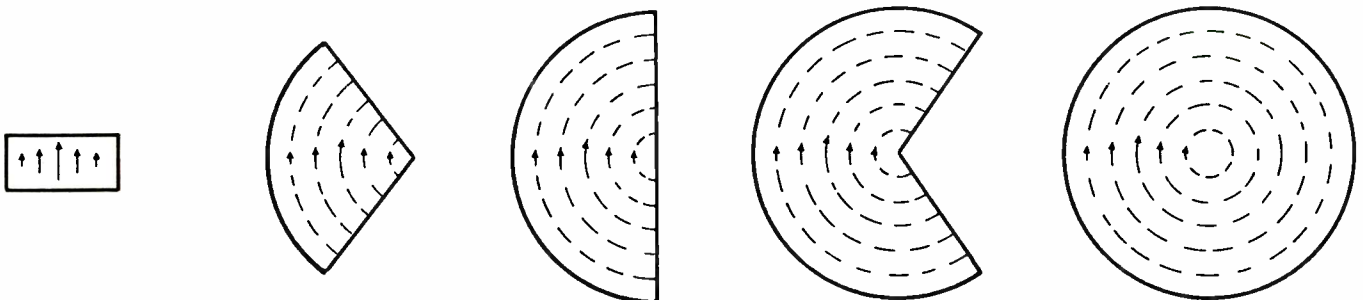

TABLE I

Transmission Line	Inside Dimensions (inches)	Theoretical Attenuation db/100 ft. in Copper over Frequency Range 140-220 KMC
TE ₁₀ rectangular (RG-135/U)	0.0510 x 0.0255	317-201
TE ₀₁ circular	0.156 dia.	19.8- 8.4
TE ₁₁ circular	0.141 dia.	22.1-23.8

Components

(Continued)

not possible to state the exact efficiency of the units due to the uncertainty of the efficiency of the detectors at these frequencies, relative power measurements made with waveguide mounted thermistor beads indicate the conversion loss to be less than 25 db.

Although harmonic generation has long been used by the microwave spectroscopist, the process has been generally rather laborious. Involving critical, hand-made units, it often took hours, or even days, to adjust. The requirement, therefore, existed for a replaceable cartridge unit which could be readily inserted into a mount and set for optimum operation with a minimum of controls.

A cartridge similar to the 4 mm. detector designed

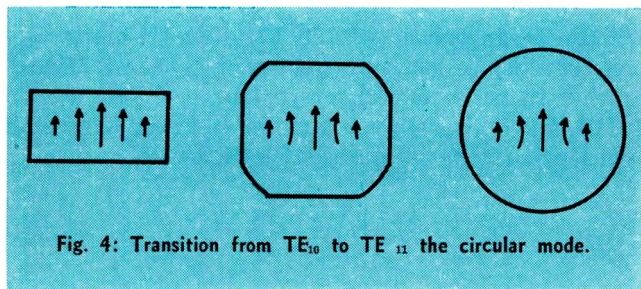

Fig. 4: Transition from TE₁₀ to TE₁₁ the circular mode.

at the Bell Telephone Laboratories¹ was decided upon, and a suitable mount was designed. Fig. 2 shows the harmonic generator mount and cartridge.

The mount is an in-line design, with the fundamental input waveguide tapering in height to the height of the harmonic waveguide at the cartridge. Past the cartridge, the waveguide width tapers to the width of the harmonic waveguide at the output flange, thus cutting off the fundamental frequency signal. Resistive matching is accomplished by laterally positioning the cartridge across the waveguide, and reactive matching is accomplished with a screw adjustment past the cartridge. The unit is comparatively broad-band, with changes in frequency in the order of several percent requiring little or no readjustment.

Waveguide and Flanges

The recommended waveguide transmission line for the 140-220 KMC frequency range is RG-135/U. Theoretical attenuation in copper of the TE₁₀ rectangular waveguide mode at 150 KMC is approximately 300 db/100 ft. or 1 db/4 in. While this waveguide could be used to fabricate measuring instruments having a short insertion length, it is impractical for the transmission of microwave energy over any reasonable distance. The characteristics of several alternative transmission lines are listed in Table 1.

The adaptability of fundamental mode TE₁₀ rectangular waveguide to the fabrication of such components as attenuators, slotted sections, phase shifters, etc., resulted in the choice of this mode for the majority of test equipment components that could be kept to a length of 2 in. (approx.).

For transmission of energy from one point to another, we should consider the circular waveguide modes. For short distance transmission, e.g., from antenna to receiver in an aircraft or between test set-ups in a laboratory, the optimum size TE₁₁ circular waveguide mode offers several advantages. Optimum size TE₁₁ circular waveguide is defined as the size which has its minimum attenuation at the given frequency. This minimum is fairly broad in the direction of increasing frequency, as can be seen from Table I.

At a frequency of 150 KMC, optimum size TE₁₁ circular waveguide is approximately 0.141 in. inside diameter. It provides an attenuation of less than 1/4 db/ft., which is tolerable for comparatively short distances. It is the simplest mode to transduce from TE₁₀ rectangular waveguide, Fig. 3. This figure represents successive cross-sections of a gradually tapered transition. The lengths of the solid arrows represent electric field strength across the cross-section. The mode can be kept reasonably pure by placing a thin wire or septum across the waveguide in a direction perpendicular to the electric field.

For transmission over relatively long distances it is necessary to use a larger diameter TE₀₁ circular waveguide mode. This mode has the desirable characteristic of continuously decreasing loss as frequency increases. It is, however, considerably more difficult to transduce from rectangular waveguide, a typical broad-band design being shown in Fig. 4. As before,

Fig. 5: Waveguide and flanges developed for use at 2mm.

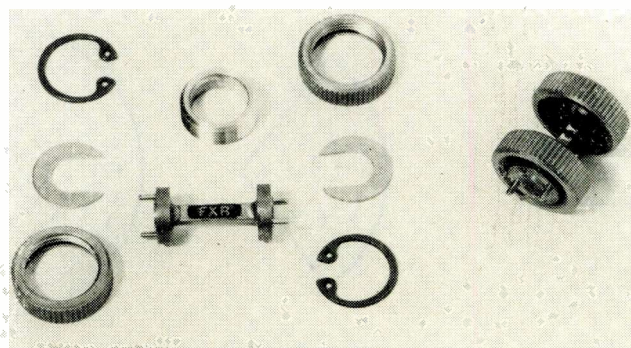

the solid arrows represent electric field strength across the gradually tapering transition. The broken lines indicate the direction of the electric field at each cross-section. Special techniques have been developed to keep mode purity in this waveguide, the mode being highly susceptible to mode conversion at slight mechanical imperfections.⁹

To keep measured attenuation values at these frequencies close to the theoretical values tabulated, it was necessary to take great care in the fabrication and assembly methods used for the components. Many of the units were electroformed on precision mandrels or precision machined from solid stock.

Another item of considerable importance is the waveguide material. Brass and aluminum result in excessive attenuation at millimeter wavelengths. Copper and silver, while lower in initial loss, corrode in time with adverse effects on attenuation. Rhodium flashing, as is done on lower frequency components, to preserve the finish, is undesirable, since at millimeter frequencies the skin depth is small and the resistivity of rhodium is high. Gold plating has, therefore, been used for the majority of components, the theoretical attenuation for gold being only about 20% higher than that for copper. A plating of a few microinches is sufficient at these frequencies, and the process also results in an attractive exterior finish.

In view of the attenuation characteristics discussed above, desirable features of a millimeter waveguide flange would include a minimum of insertion length as well as positive alignment and contact between mating waveguide surfaces. The flange developed for use at 2 mm. is shown in Fig. 5. The use of captive coupling nuts, rather than screws, for assembly results in a minimum of required waveguide length for the flange. The pins and raised contact area assure accurate alignment and contact for mating waveguides. Finger pressure is normally sufficient for engagement and disengagement of flanges, eliminating the requirements for special wrenches or other tools.

Other Components

A universal detector mount, capable of operating with replaceable crystals, bolometer, or thermistor cartridges, was developed for the detection of 2 mm. signals, Fig. 6. The cartridge and tuning arrangement are similar to that used in the harmonic generator, and are based on the Bell Telephone Laboratories design referenced.¹ The detecting element is mounted directly in the waveguide section of the cartridge for optimum sensitivity. Later models of the cartridges

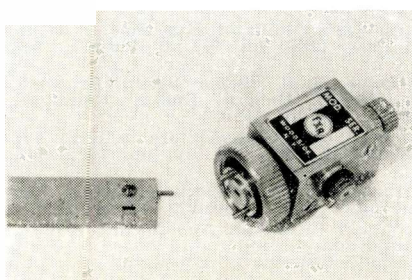

Fig. 6 (left): Crystal detector mount and cartridge developed for use at 2mm.

Fig. 8 (right): Modified slotted section for the measurement of VSWR in schematic form.

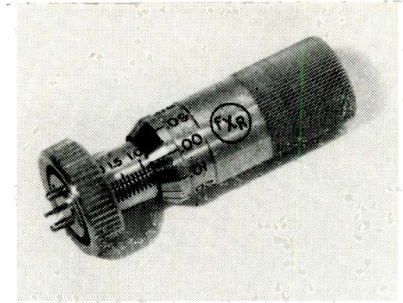

Fig. 7: The micrometer barrel of this precision sliding short has a least count of .0005 millimeter.

include a thin mica window over the waveguide opening in the cartridge for protection of the detecting element.

The crystal detector cartridge uses a boron-doped p-type silicon dicing. Point contact is made through a 0.001 in. diameter tungsten whisker. The video sensitivity of the crystal, when used in conjunction with the harmonic generator described above, was sufficient to allow the design and testing of the complete line of 2 mm. components. It was generally possible, when operating from a 4 mm. source having an output power of at least 10 mw. square-wave modulated, to obtain a 2 mm. signal of over 40 db above the noise level of a commercial VSWR amplifier.

The Wollaston wire bolometer cartridge is assembled by deplating the silver coating from the 16 microinch platinum core of a Wollaston wire mounted across the waveguide opening. The units are fairly rugged and just about as sensitive as the crystal detectors at 2 mm. Care must be taken to limit the bias current and the r-f power applied to these units. Thermistor beads were also mounted in the detector cartridges with the best units indicating 2 mm. power levels of over 100 microwatts. There is, however, some doubt as to the efficiency of these units, so that the actual 2 mm. power obtained may be somewhat more than this figure.

A precision sliding short was designed for use as a drive or plunger at 2 mm. The short consisted of a differential screw micrometer drive having an advance of 0.1 mm. (0.004 in.) per revolution. As can be seen from Fig. 7, the micrometer barrel, with a least count of 0.005 mm., can be used for interpolation to ± 0.001

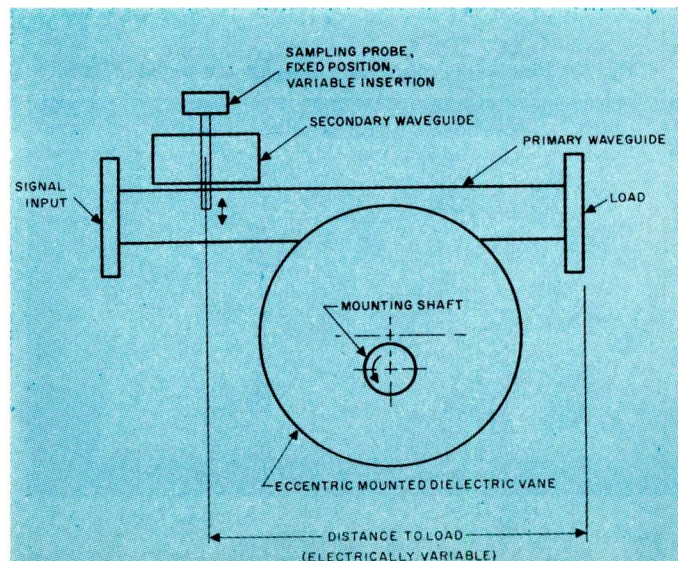

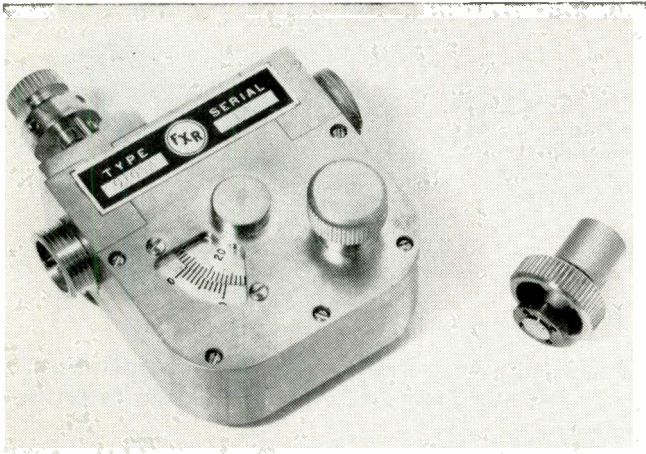

Fig. 9: Slotted section and the fixed short, showing the precision milled block construction of the unit.

Components (Concluded)

mm. The circular choke plunger was adapted for use in an E/H tuner and a frequency meter.

A modified slotted section, consisting of a fixed position probe followed by an adjustable phase shifter, was designed for the measurement of VSWR and is shown schematically in Fig. 8. The phase shifter consists of a thin eccentric mounted mica disc, the insertion of which can be varied inside the waveguide. Thus, the phase of the standing wave produced by an unknown load can be moved past the fixed probe, providing an effect similar to that experienced by the moving probe in a conventional slotted section. A fixed waveguide short circuit is supplied with each slotted section to provide for calibration and correction for the insertion loss at these frequencies when accurate measurements of high VSWR values are required. Fig. 9 is a picture of the slotted section and the fixed short, showing the precision milled block construction of the unit.

Among the other components designed and tested at 2 mm. are frequency meters, variable attenuators, standard gain horns, transitions, tuners, power dividers, bends, terminations, etc. Some of these are shown in Fig. 10. Specifications such as VSWR and

Fig. 10: Some of the components designed and tested at 2mm.

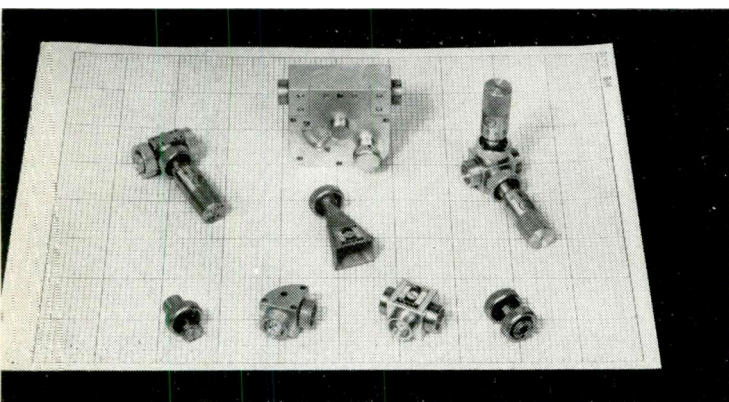

calibration accuracy for attenuators and frequency meters are not much worse than those usually quoted on similar items at lower frequencies. Insertion loss of most of the components can be held to less than 1 db. It should be emphasized that most of the data for these components was taken in the frequency range 140-150 KMC, due to the limited availability of signal sources. However, the broad-band design of the components should allow their use up to the 220 KMC waveguide limit. An attempt was made to operate these units at the third harmonic of the fundamental source, and, in fact, signals were noted between 210-220 KMC. These signals were too weak, however, to allow for quantitative measurements.

Although the above descriptions refer only to components in RG-135/U waveguide size, a parallel line of test equipment was developed for RG-138/U waveguide (90-140 KMC). The inside dimensions of RG-138/U are 0.080 in. x 0.040 in., as compared to 0.051 in. x 0.0255 in. for the internal dimensions of RG-135/U. For measurements in the vicinity of 140 KMC and lower, RG-138/U components would certainly be preferable from an attenuation standpoint. It should be realized that at 140 KMC the attenuation in RG-135/U waveguide is approximately 300 db/100 ft. whereas the attenuation in RG-138/U waveguide is "only" 100 db/100 ft. approx.

REFERENCE PAGES

The pages in this section are perforated for easy removal and retention as valuable reference material.

SOMETHING NEW HAS BEEN ADDED

An extra-wide margin is now provided to permit them to be punched with a standard three-hole-punch without obliterating any of the text. They can be filed in standard three-hole notebooks or folders.

Acknowledgment

The work described in this paper was sponsored by the U. S. Atomic Energy Commission under a subcontract from the University of Illinois, Urbana, Illinois. The author would like to acknowledge the assistance of L. R. Brecht, Jr., B. Packer, and M. Wiesenfeld in performing this work. He is also indebted to Prof. P. D. Coleman of the University of Illinois, who supervised the subcontract, and J. Ebert for their many helpful discussions.

References

1. Bell Telephone Laboratories, Inc., "Final Report on Millimeter Wave Research," *Contract NONR-687(20)*; Oct. 1955.
2. Heald, M. A., "Microwave Measurements in Controlled Fusion Research," *IRE National Convention Record, Part 9*, pp. 14-18; Mar. 1958.
3. Coleman, P. D., and Becker, R. C., "Present State of the Millimeter Wave Generation and Technique Art," *IRE Transactions*, vol. MTT-7, pp. 42-61; Jan. 1959.
4. Kaufman, I., "The Band Between Microwave and Infrared Regions," *Proc. IRE*, vol. 47, pp. 381-396; Mar. 1959.
5. Karp, A., "Backward-Wave Oscillator Experiments at 100 to 200 Kilomegacycles," *Proc. IRE*, vol. 45, pp. 496-503; Apr. 1957.
6. Manley, J. M., and Rowe, H. E., "Some General Properties of Nonlinear Elements—Part I. General Energy Relations," *Proc. IRE*, vol. 44, pp. 904-913; July, 1956.
7. Uhlir, A., "The Potential of Semiconductors in High Frequency Communications," *Proc. IRE*, vol. 46, pp. 1099-1115; June, 1958.
8. Page, C. H., "Frequency Conversion with Positive Nonlinear Resistors," *Journal N.E.S.*, vol. 56, pp. 179-182; Apr., 1956.
9. Beck, A. C., "Measurement Techniques for Multimode Waveguides," *Proc. of the Symposium on Modern Advances in Microwave Techniques*, Polytechnic Institute of Brooklyn, vol. 4, pp. 325-341; Nov. 1954.

Computer availability has increased the use of insertion-parameter methods in the design of LC filters. The development of these methods for crystal filter design has been lagging. This article shows how to apply these techniques to the design of improved single sideband crystal filters.

Using Insertion Parameters for Filter Design

By **HEINZ J. KAMMIN**

Chief Network Engineer
Reeves-Hoffman Div.
Dynamics Corp. of America
Carlisle, Pa.

THE main reasons for the delay in designing crystal filters by insertion-parameter methods are: (1) the requirement that the final form of the network has to include a configuration equal to the equivalent circuit of a crystal resonator and (2) the limited range of the available electrical crystal parameters.

The design of insertion-parameter filters requires much greater computational work than the design of image-parameter filters. The disadvantage, however, is offset by the use of electronic computers. Hence the insertion-parameter method has become an everyday tool for many filter designers, and a knowledge of its principles can be presumed. The approach to the crystal-filter design given in this article is based on the principles generally observed in LC filter design.

This article considers unsymmetrical bandpass

filters only. The increasing demand for such filters in single sideband (SSB) transmission is the primary reason for the decision. The general procedure, however, can be applied to other filter types.

Evaluation of Transfer Function

The design of an insertion-parameter filter starts with the derivation of the "characteristic function" $\varphi(\lambda)$, where λ = normalized frequency. This function in its final form is a quotient of the two polynomials $h(\lambda)$ and $f(\lambda)$, of which $h(\lambda)$ determines the zeroes and $f(\lambda)$ the poles of the network. Both polynomials are functions of the normalized frequency $\lambda = j \frac{\omega}{\omega_0}$, where ω = circular frequency, and ω_0 = bandpass center circular frequency. The relationship

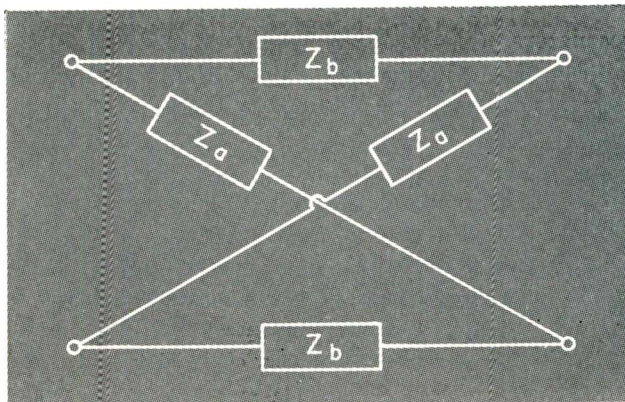
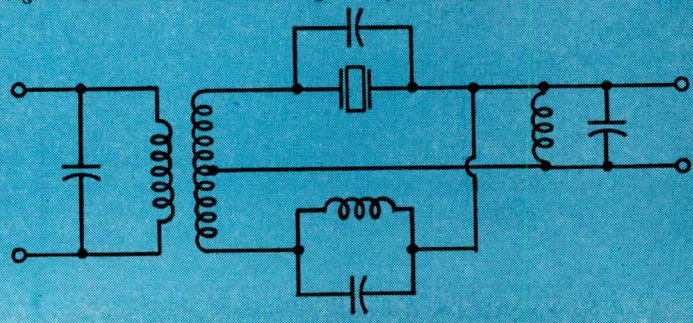

Fig. 1: The lattice circuit and its equivalents are the most widely used configurations for the realization of crystal filters.

Fig. 2: Schematic of a sixth-degree crystal single sideband filter.



Insertion Parameters

(Continued)

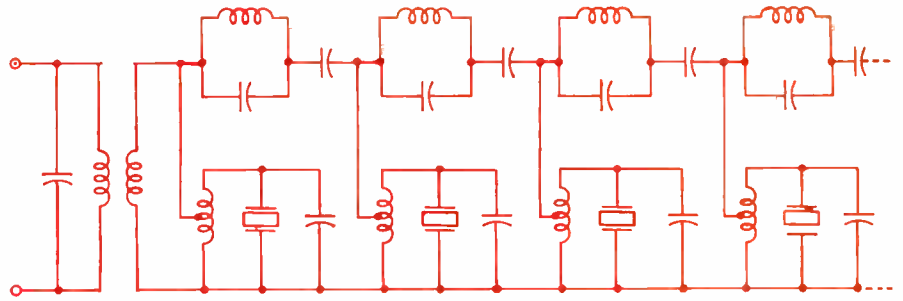

Fig. 4: Schematic of a ladder filter using quartz crystals.

between the characteristic function $\phi(\lambda)$ and the aforementioned two polynomials is given by:

$$\phi(\lambda) = \frac{h(\lambda)}{f(\lambda)}$$

The next step is the evaluation of the "transfer function" $S(\lambda)$. $S(\lambda)$ is also a quotient of two polynomials:

$$S(\lambda) = \frac{g(\lambda)}{f(\lambda)}$$

The relationship between the "characteristic" and "transfer" functions is given by:

$$|S(\lambda)|^2 = 1 + |\varphi(\lambda)|^2$$

and derived from this is the relation between the three mentioned polynomials:

$$g(\lambda)g(-\lambda) = h(\lambda)h(-\lambda) + f(\lambda)f(-\lambda)$$

The requirements for the three polynomials are known. Here we just point out the most important condition:

The polynomial $g(\lambda)$ has to be a Hurwitz polynomial whose zeroes lie in the left λ -half-plane. This condition requires the calculation of the roots of:

$$h(\lambda)h(-\lambda) + f(\lambda)f(-\lambda)$$

and constitutes the most difficult part of the design procedure. The transmission function $S(\lambda)$ describes the properties of a four-pole network and the element values of the network can be derived from this function.

The two polynomials of the characteristic function for a crystal filter can be found by the same methods

already known in LC filter design. For an unsymmetrical bandpass these polynomials can be derived either with the use of Cauer's q -functions^{1, 2, 3} or with Darlington's formula for reference filter.⁴

This procedure does not differ from the known application of these methods in the design of LC filters. Because of the higher selectivity of crystal filters, however, a greater accuracy (more significant digits in all numbers) is required.

Realization as Lattice Network

The lattice and its equivalents are the most widely used configurations for the realization of crystal filters, Fig. 1. The branch impedances of a lattice can be derived from the transfer function $S(\lambda)$. However, certain restrictions exist with respect to the realizability as a crystal filter. The transmission function $S(\lambda)$ has to be of at least the sixth degree to obtain one lattice branch in the form of the equivalent circuit of a crystal.

For an even degree of $g(\lambda)$ and an odd degree of $f(\lambda)$, Cauer¹ shows the branch impedances of a lattice network:

$$Z_a = \frac{G_o + f(\lambda)}{G_e - h(\lambda)} \quad Z_b = \frac{G_o - f(\lambda)}{G_e - h(\lambda)}$$

where,

- G_o = odd part of polynomial $g(\lambda)$
- G_e = even part of polynomial $g(\lambda)$

In most cases the dual branch impedances were found to be more useful for the final realization because they lead to configurations with a coil in parallel to the rest of the circuit. This shunt coil permits a transformation of the electrical crystal parameters into available values.

The computation of the normalized element-values leads directly, or with an appropriate transformation, to two-poles partially realizable with crystal resonators.

From such normalized values the actual circuit elements can easily be obtained by the following transformation:

$$L = \frac{l \cdot R_1}{\omega_o} \quad C = \frac{c}{\omega_o \cdot R_1}$$

where,

- L = actual inductance
- l = normalized inductance
- R_1 = nominal impedance
- ω_o = center frequency of the filter
- C = actual capacity
- c = normalized capacity

Fig. 2 shows the schematic and Fig. 3 the meas-

Fig. 3: Insertion-loss performance of the filter shown in Fig. 2.

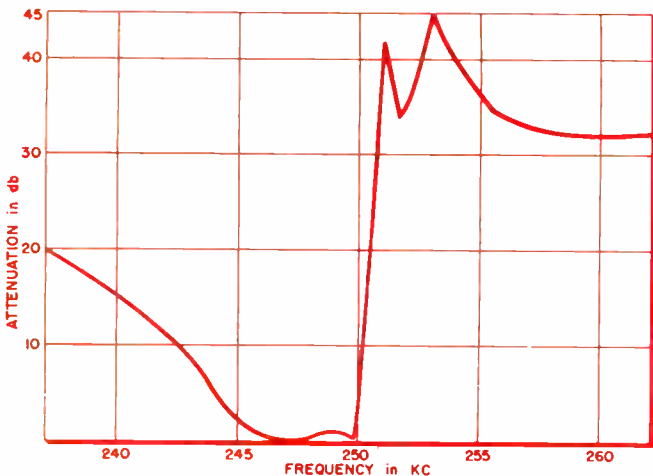

A REPRINT

of this article can be obtained by writing on company letterhead to
The Editor
ELECTRONIC INDUSTRIES, Chestnut & 56th Sts., Phila. 39, Pa.

ured insertion loss performance of a sixth-degree SSB filter, using one crystal.

Realization as Ladder Network

The general configuration for an LC filter is the ladder network. However, this configuration recently gained more consideration in the design of broad band crystal filters.⁵

The open- or short-circuit impedances of such a ladder network can also be derived from the transmission function $S(\lambda)$, and this method is similar to the procedure for obtaining these impedances in LC filter design. The computation of the normalized element values from these impedances leads—if properly directed—to a ladder filter, which can be realized as a combination of crystals and normal coils and capacitors. The crystal resonators maintain the steeper poles while coils and capacitors are responsible for the poles further removed from the cutoff frequencies.

Also in this case the shunt coils parallel to the crystals provide a convenient way of adjusting the calculated electrical crystal parameters to available values. The conversion of the normalized elements into the actual values can be carried out by the relations shown under the section headed Realization as Lattice Network. Such crystal ladder filters can be built with bandwidths much broader than the conventional lattice configuration.

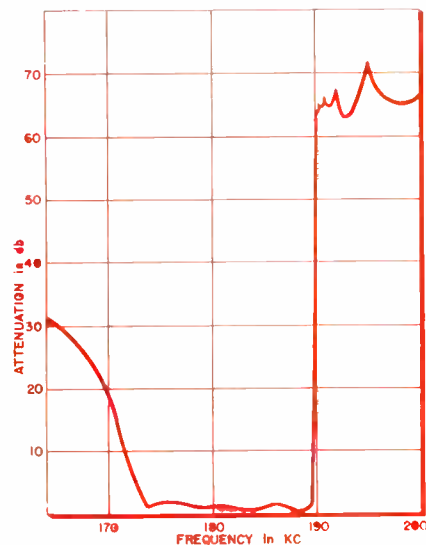

Fig. 5: Insertion-loss performance of the filter circuit of Fig. 4.

Fig. 4 shows the schematic and Fig. 5 the measured insertion-loss performance of a crystal ladder filter.

Acknowledgment

The author expresses his appreciation to Dr. Louis Bauer and Dr. Frances Bauer, of Reeves Instrument Co., Div. of Dynamics Corp. of America, who carried through the calculations necessary for this paper.

References

1. Cauer, W., *Theorie der linearen Wechselstromschaltungen*. Berlin 1954.
2. Fetzer, V., "Die numerische Berechnung von Filterschaltungen mit allgemeinen Parametern nach der modernen Theorie unter besonderer Berücksichtigung der Cauerschen Arbeiten." *Archiv der elektrischen Übertragung* 5, 1951.
3. Fetzer, V., "Explizite Berechnungsformeln für Filterschaltungen mit allgemeinen Parametern," *Archiv der elektrischen Übertragung* 5, 1954.
4. Darlington, S., "Synthesis of reactance 4-poles," *J. Math. Phys.*, vol. 27, 1938.
5. Poschenrieder, W., "Steile Quarzfilter grosser Bandbreite in Abzweigschaltung," *Nachrichtentechnische Zeitschrift*, 12, 1956.

New Photo Electric Transducers

PHOTO electric force and motion transducers have not been widely accepted in the missile field, due to the long term stability problem and the large displacement required of a sensor. But new materials and circuit designs have been devised at White Avionics Corp., Terminal Rd., Plainview, N. Y., which greatly extend the range of applications.

First: control of the light source over long periods of time can be accomplished by maintaining a tungsten element light source at a low temp. and providing feed-back control from a photo conductive diode. A tungsten element at 2400° F will yield a peak intensity in the near infrared region and a photo diode

can be selected for max. sensitivity in the same region.

There are a number of approaches possible in the feed-back control. Some have been patented.

Second: new n-type photo diodes where a p-type region is established around a point of contact, have improved the re-combination rate. Such photo diodes are also small—allowing miniaturization. Third: the improvement in circuitry and components for the associated amplifier further allow for miniaturization and high reliability.

The output of the photo pickoff transducer can be designed for either digital or analog control systems depending on the sensor. The

former needs a sensing mechanism which can yield a change in frequency proportional to the change in input of the phenomena measured. With sufficient displacement of the sensor, to interrupt the light path between the control source and a photo diode, a pulse output can be obtained as a function of the input. The latter requires a sensor for measuring a phenomenon whose displacement is proportional to the input. By using this displacement to interpose a shutter in the light path between the controlled source and a photo diode, an output is obtained whose amplitude is a function of the input. This makes it compatible with an analog system.

Silicon photocells offer a number of advantages in data processing equipment and for low-light-level sensing operations. However, for various reasons design engineers are often uncertain about how to use these devices. Here the photocell characteristics are analyzed and explained.

Understanding Silicon Photocells

By WERNER LUFT
*Chief Design Eng.
 International Rectifier Corp.
 El Segundo, Calif.*

THE silicon photocell is a device which converts light energy directly into electric energy. It exhibits a very fast response time, low noise output, and stable output characteristics. In addition, it displays no fatigue effects and has virtually unlimited life expectancy.

The main advantage of the silicon cell over other photocells is its short transient response time. This allows its use for the reading of flying punched cards or fast moving tapes. The transient response time is about 10 microseconds. The response time is, however, a function of the load resistance, being proportional to the load resistance over a fairly wide range. In some cases a high load resistance is desirable for maximum output signal. However, the increased transient response time sets an upper limit for the magnitude of load resistance which can be used.

To a lesser extent, the transient response time is an inverse function of the applied bias voltage. Since a higher bias voltage lowers the cell capacitance, it also reduces the response time.

Mechanical Features

For perforated tape or punched card readers in data processing equipment, large cells are subdivided by scribing and etching them into small segments. Each segment within the module has its own

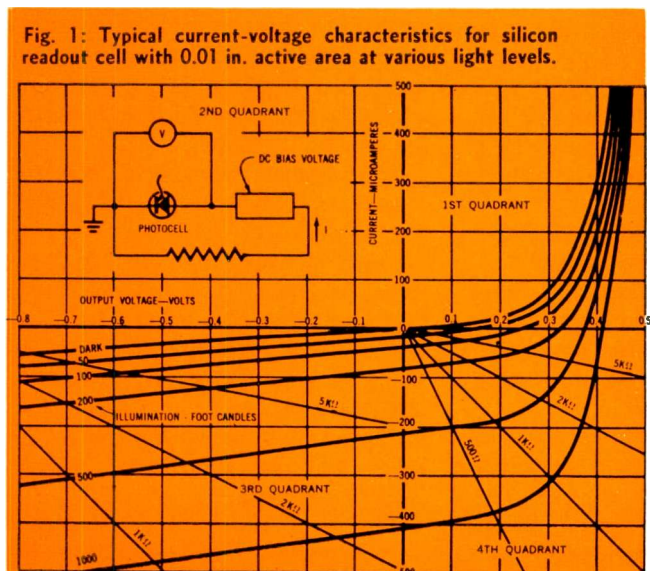

A REPRINT
 of this article can be obtained by writing on company letterhead to
The Editor
ELECTRONIC INDUSTRIES, Chestnut & 56th Sts., Phila. 39, Pa.

positive contact area but a common negative terminal. For ease of mounting, the modules can be soldered to metal bases and may be subsequently assembled into complex matrices as required.

The dimensions and spacing of individual cell segments in a module are designed to meet system requirements. But since each array is formed from a large single crystal cell, uniform response from segment to segment in one module is assured.

Operation

The operation of the silicon readout photocell may be compared to the operation of a rectifier diode in parallel with a current generator. With no light on the cell surface, the photocell has the same basic current-voltage characteristic as the silicon diode. This is illustrated by the "dark current" characteristic in Fig. 1.

Light falling on the cell, however, acts as a current generator and the characteristic is displaced along the ordinate. Fig. 1 illustrates the variation of output characteristics with illumination level. A typical value of generated current is $400 \mu\text{a}$ for a 0.01 sq. in. active cell area at 1000 footcandles of illumination.

If the spectral distribution of the light source remains constant, the light-generated short-circuit current varies linearly with light intensity. Fig. 2 illustrates typical values of the short circuit current as a function of light intensity from a tungsten filament lamp operated at approximately 2800°K .

The silicon photocell may be used in either reverse biased operations, or in unbiased operations. In the former, it acts as a photodiode. In the latter case, its self-generated power is used.

Unbiased cells will display the output characteristics shown in the 4th quadrant of Fig. 1. Reverse biased cells, however, will have characteristics in both the 3rd and 4th quadrants but the operation should be restricted to the 3rd quadrant (reverse biased junction) to eliminate clipping of the signal.

Unbiased Operation

Unbiased operation of the silicon photocell is practical where the power output from the cell is sufficient for direct operation of relays or for transistor switching. For equipment in remote areas where untended operation is desired, unbiased cells provide continuous photosensing without the need of a battery or other power source.

When working into a constant load resistance, any changes in light level will produce a change in voltage and current. The higher the resistance, the higher the output voltage at a given light level. At infinite resistance, the (open-circuit) voltage varies logarithmically with the light intensity, as shown in Fig. 3.

The current varies linearly with light intensity at low load resistance, while at higher load resistances it approaches a logarithmic function of the light intensity. Fig. 4 shows typical values of current density versus illumination level for silicon cells at room temperature and illuminated by a tungsten filament source. The parameter is load resistance times active cell area.

Fig. 2: Short circuit current vs. illumination intensity for readout cell.

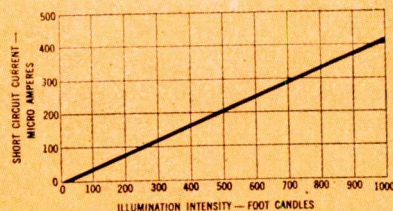
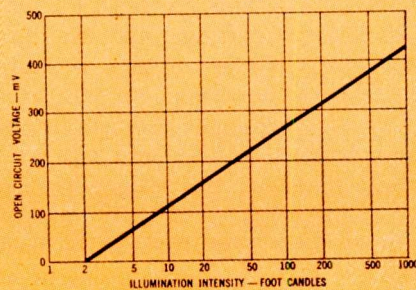

Fig. 3: Open circuit voltage is plotted against illumination intensity.



From module to module, the output characteristics will vary within certain limits, but within each module the variations are quite small, as stated previously. Figs. 5 and 6 show the normal spread in output characteristics for modules at 15 and 600 footcandles of illumination, respectively.

To increase the output voltage, cells may be connected in series, but at low light intensities the load impedance must be high in order to obtain appreciable voltage gain. This is illustrated by the following examples.

One cell, with characteristics shown by the heavy line in Fig. 5, has an output voltage of 81 mv at 50 K ohms load resistance. If ten such cells are connected in series, the output at the same load is only 210 mv, or only 2.6 times as much as for one cell. A further increase in the number of cells in series will not

Fig. 4: Cell output current density vs. illumination intensity.

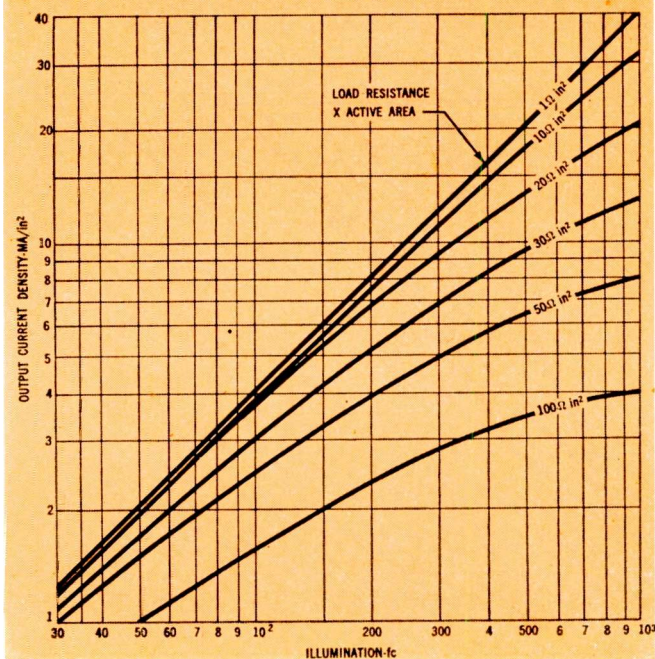

Silicon Photocells (Continued)

increase the output voltage ratio to any significant extent.

At 10^6 ohms load resistance, however, a different voltage ratio is obtained. The output voltage is 116 mv from a single cell, and 960 mv from ten cells in series, or 8.3 times as much as for a single cell.

If the load voltage and the light level are both fixed and a higher voltage is desired, then the cell area can be increased. An increase in cell area by a factor of 10 changes the cell output voltage at 50 K ohms from 81 mv to only 113 mv. For ten cells in series, however, the output voltage increases from 210 to 810 mv.

If the light intensity can be increased, it is much easier to achieve a certain output voltage. This is as shown in Fig. 6. Only three cells in series at 600 footcandles illumination are required to yield 1 volt output at 50 K ohms load resistance.

Biased Operation

Reverse biased operation is the rule when the cells are used as light sensors for transistor bias control in perforated tape or punched card readers. In this case, the negative terminal of a battery is connected to the top (anode) terminal of the silicon readout cell. The cell is operated in the 3rd quadrant and acts as a photoconductive element (photodiode).

The optimum load for a photodiode is that which produces the highest voltage change for a given change in light intensity. From Fig. 1 it is seen that the highest load resistance yields the largest voltage change. Care should be taken to insure that the change in light intensity does not drive the photodiode into the forward bias condition, leading to saturation and signal clipping.

Fig. 5: The normal spread in output characteristics for cell modules is shown for light intensity of 15 footcandles.

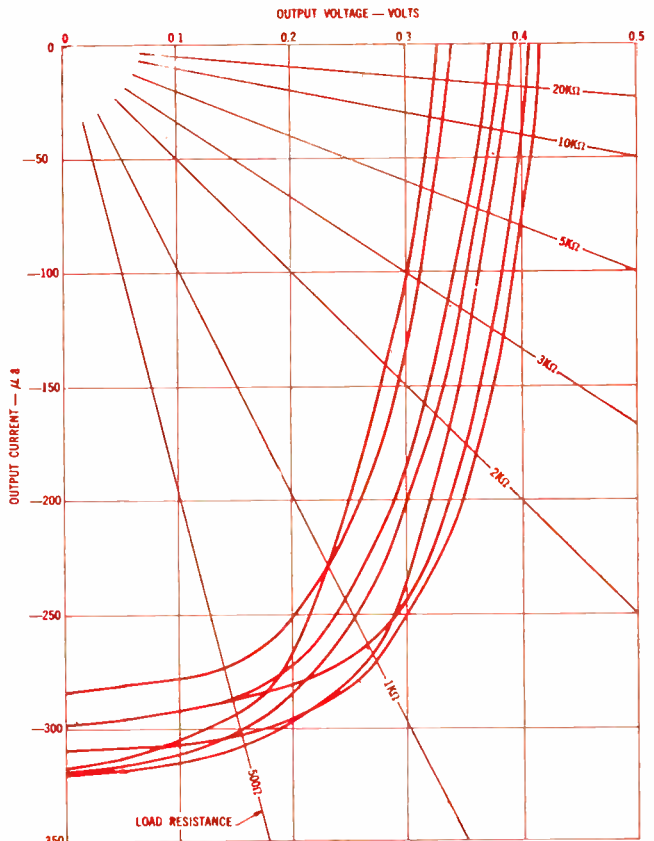
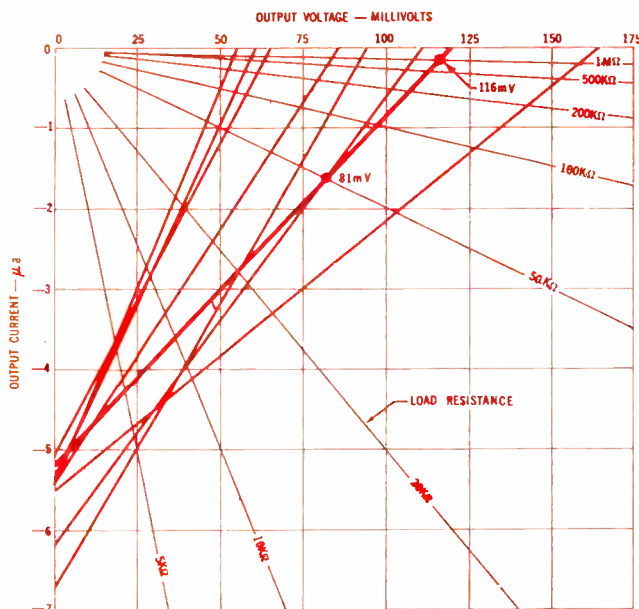

Fig. 6: With light intensity of 600 footcandles, the normal spread in output characteristics for cell modules is shown.

To aid the circuit designer in selecting a consistent and optimum set of values for illumination level, bias voltage, and external load resistance, the following explanation of silicon photodiode characteristics is offered.

Fig. 7a shows the basic circuit when the photocell is operated in a reverse biased condition. Fig. 7b illustrates the current-voltage characteristics over the variable resistance R at a given constant illumination level and bias voltage V_2 . The corresponding characteristic for the silicon photocell is shown in Fig. 7c.

From Fig. 7c it can be seen that the voltage is negative for external load resistances from zero to R_s . For a load resistance larger than R_s , the voltage V_1 becomes positive. The value of R_s at which the voltage changes from negative to positive depends on the bias voltage V_2 and the illumination level. A negative voltage V_1 indicates that the cell is not generating an emf, but instead is acting as a resistor.

The apparent resistance of the cell is not only dependent on the illumination level, but also on the bias voltage V_2 and on the series resistance R . The apparent resistance R_c of the cell for each set of illumination, bias voltage and external load can then be determined from

$$R_c = \frac{-V_c}{-I_c}$$

as indicated in Fig. 7d.

It can be seen that at low light levels the apparent resistance R_c is high and decreases with increasing

illumination. At a certain illumination level, R_c becomes negative, which means that the cell is generating a positive emf. Furthermore, it is clear from Fig. 7d that the apparent resistance is not only a function of illumination level, but also of the bias voltage V_s and of the load resistance. An increase in bias voltage increases the apparent resistance, whereas (all other factors being constant) an increased load resistance decreases it.

Photodiodes are usually operated to be either in the dark or illuminated, but variation from one light level to another is also possible. A greater change in illumination level will produce a greater change in output signal.

An increase in cell size has the same effect as an increase in illumination intensity so that the output signal is approximately proportional to the product of illumination intensity and cell area. Although the voltage change will, of course, depend on the load resistance, the current variation is about 40 microamperes per square inch—footcandle.

At a constant load resistance (input impedance), a change in bias voltage does not affect the output voltage signal, but a lower bias voltage gives a better ratio of signal to no-signal voltage. A high bias voltage is often desirable as it permits the use of a higher input impedance without the risk of driving the cell into forward bias condition and of clipping the signal.

The limit on bias voltage is set by the breakdown voltage of the silicon photocell. Standard readout cells are selected to have a reverse breakdown voltage above 20 volts, with a maximum room temperature dark current of 1 ma at 20 volts. By special selection, cells having a reverse breakdown voltage as high as 50 volts are available.

REFERENCE PAGES

The pages in this section are perforated for easy removal and retention as valuable reference material.

SOMETHING NEW HAS BEEN ADDED

An extra-wide margin is now provided so as to permit them to be punched with a standard three-hole-punch without obliterating any of the text. They can then be filed in standard three-hole notebooks or folders

Cell Sensitivity

Cell sensitivity is determined by two factors:

The dark resistance, and the light generated current per unit light intensity.

The lower the dark current at any given voltage, the higher is the dark resistance and the higher also is the sensitivity.

This is clarified by Fig. 8, wherein Fig. 8a describes a cell with low dark resistance, and Fig. 8b a cell with higher dark resistance. Changing from the dark condition to a certain illumination, indicated by the line "light current 1," gives a greater voltage change (b_1) for the high dark resistance cell than for the lower dark resistance cell (a_1). Both cells have the same light generated current per unit light intensity.

A higher current per unit light output, as indicated by the line "light current 2" in Fig. 8a, increases the voltage change to a_2 . A higher current

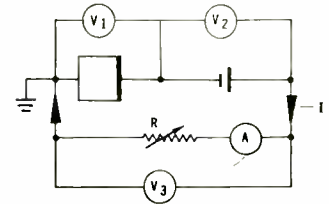

Fig. 7a: The basic circuit when photocell is operated in reverse bias condition.

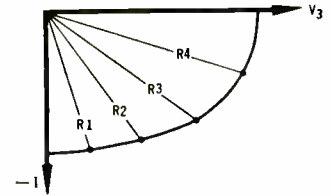

Fig. 7b: The I-E characteristic over variable load resistance.

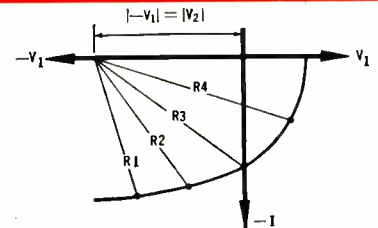

Fig. 7c: Current-voltage characteristic over silicon cell.

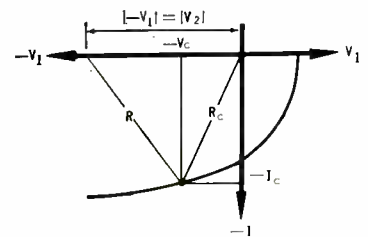

Fig. 7d: Apparent cell resistance is a function of illumination level, bias, and load resistance.

per unit light intensity can therefore offset the higher dark resistance (as a_2 compared to b_1).

The best cell will, of course, combine high light current with high dark resistance and give the greatest voltage change as indicated by b_2 .

Standard cells of 0.01 sq. in. of active area have a maximum room temperature dark current of 20 μ a at 0.5 volts. For higher sensitivity, cells with lower dark currents are available. The current at any given bias increases with temperature and the dark current increases more rapidly than the light current. The photodiode sensitivity, therefore, decreases with increased temperature.

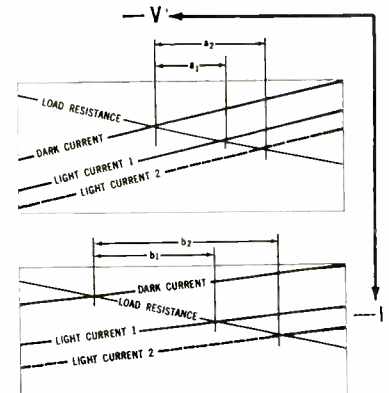

Fig. 8a & b: Graphs illustrate the effect of dark resistance and light current per unit illumination on the cell sensitivity.

After graphically analyzing the tunnel diode's action as a square wave generator, this article synthesizes a pulse generator which exploits the device's ability to switch more rapidly through the peak, rather than valley, current region.



By PAUL MAUCH
Senior Engineer
Ampex Data Products Co.
Redwood City, Calif.

The Tunnel Diode as a Pulse

THE tunnel diode in a constant current circuit as a square wave generator is now fairly well known. The input waveform causes the tunnel diode current, Fig. 1, to move from (1) through I_p to (2) and then through V_v back to (1). The input waveform must have sufficient amplitude in one direction to move I from (1) to (2) and in the other direction from (2) back to (1).

Setting (1) near I_p will enable the tunnel diode to be flipped readily from (1) to (2); but it will be more difficult to reset to (1) when the input potential is reversed. Setting (1) nearer to I_v will make it more difficult to flip from (1) to (2), but, easier to reset to (1). Also the use of such methods to increase input sensitivity in either direction will result in an asymmetrical output waveform.

The constant current, flip-flop circuit of Fig. 2, uses a TI gallium arsenide tunnel diode. This circuit is noteworthy for providing greatly increased sensitivity of the tunnel diode to both positive and negative excursions of the input waveform while maintaining a

symmetrical output waveform. The tunnel diode trigger points are set at (1) and (3) and the V/I curve by R_L (D_1 not conducting) and R_L and R_1 (D_1 conducting)

$$R_L = \frac{E}{I_L}$$

and

$$R_1 = \frac{V_v}{I_L - 1.1 I_v}$$

where

$$I_L = 0.9 I_p$$

I_p = tunnel diode peak current

I_v = tunnel diode valley current

V_v = tunnel diode valley voltage

When the circuit is at rest, with T conducting at (1) and D_1 cut off, the application of a negative going input will cause the tunnel diode to flip rapidly from (1) to (2). D_1 will now conduct and the tunnel diode operating point will immediately move to (3) because of the shunting effect of R_1 . The tunnel diode will now rest at (3) but will rapidly return to (1) when the input goes positive. The diode D_1 should be a high speed switching germanium type. The negative going input sensitivity is increased because (1) can be set just below I_p . No loss of positive going input sensitivity is encountered because input power is not dissipated driving the tunnel diode current from (2) to (3).

With the alternative pulse waveform input shown in Fig. 2, the output waveform will have better shape at its fall than at its rise. A pulse input is more effective than a sine wave input in driving the tunnel diode current rapidly from (3) to (1). The output of Fig. 2 does have a somewhat shorter rise time at its rise than at its fall. If the fall of the waveform is of greater in-

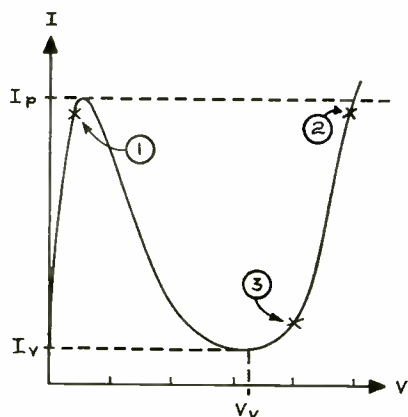

Fig. 1: The well known characteristic curve of the tunnel diode.

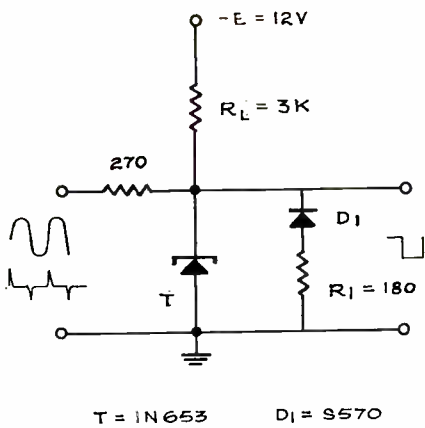
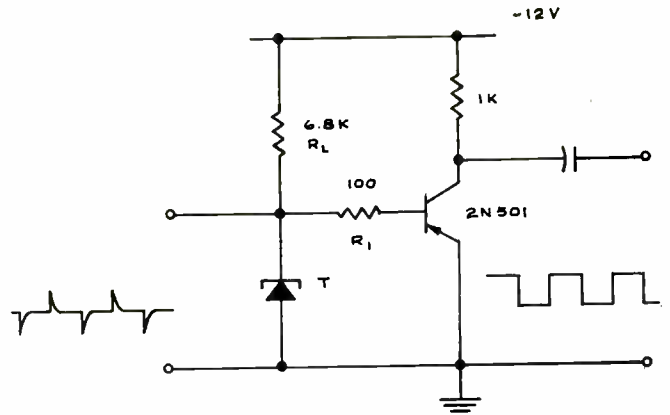

Fig. 2 (left): A gallium arsenide tunnel diode is used in this constant current flip-flop circuit.

Fig. 3 (right): Constant current flip-flop and amplifier circuit.



T = 1N653 D1 = S570

Generator

terest, its shape may be improved by reversing T, D₁ and the 12-volt supply of Fig. 2.

An immediate development was the circuit, Fig. 3, which uses a transistor's base-to-emitter diode to switch the tunnel diode shunt resistor. This, however, proved unsatisfactory because of the poor recovery time of the transistor from saturation. Biasing of the transistor, Fig. 5, proved very satisfactory for pulse input, but the output waveform reset was not good for a sine wave input. The waveforms for Fig. 3 are given in Fig. 4.

The circuit of Fig. 6 was evolved to improve the response of the circuit to a sine wave input. T₁ and D₁ operate as already described. The additional tunnel diode, T₂, is biased to sit at (3) of Fig. 1 and serves to improve the recovery of the 2N501 from saturation by resetting rapidly to (1) when the input waveform goes positive, causing D₂ to conduct. This is shown in Fig. 7. T₁ current moves from (1) to (2) to (3) and back to (1) as T₂ current moves from (A) to (B) to (C) and back to (A). This causes the 2N501 to be

Fig. 4: The input and output waveforms for the circuit of Fig. 3.

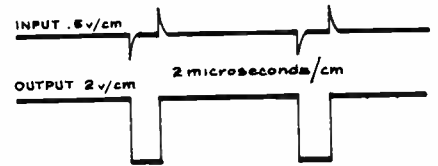
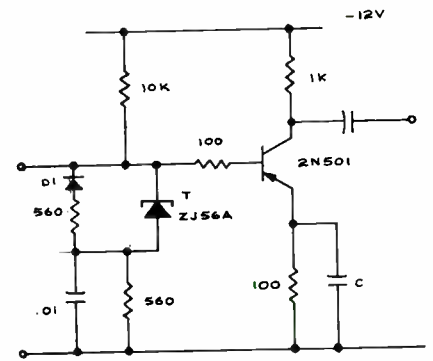

Fig. 5: An improved version of the circuit shown in Fig. 3.



driven into saturation by T₁, switching from (1) to (2) and out of saturation by T₂ switching from (A) to (B), thereby exploiting the ability of the tunnel diode to switch more rapidly through the I_p peak region than through the I_v region.

The circuit of Fig. 6 has a good frequency response and has functioned well at frequencies above 10 MC. The value of the capacitor C in Figs. 5 and 6 should be adjusted for optimum output pulse shape at the frequency in use. A typical value for C is 100 pfd.

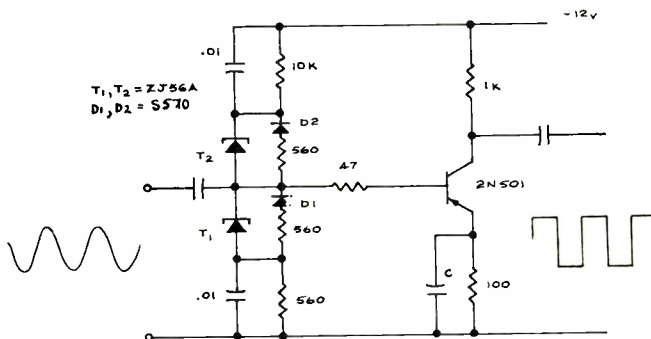
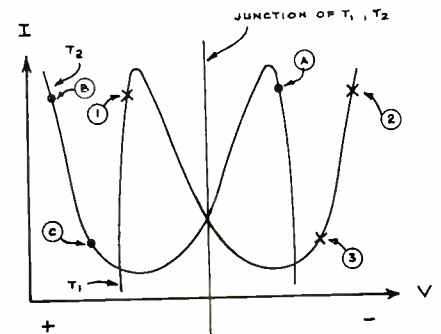

Fig. 6 (left): This flip-flop is triggered by a sine wave input.

Fig. 7 (right): Curves for the circuit shown at the left, Fig. 6.



What's New

Potentiometer Uses Strain Gage

A NEW industrial process potentiometer developed by Brown Instruments Div. Minneapolis-Honeywell Regulator Co., Phila., Pa., uses an electro-mechanical strain gage as the rebalancing element. By eliminating the conventional slidewire, infinite resolution is achieved. The balancing element is called a "Stranducer."

Four looped-wire strands form the variable resistance legs (Wheatstone bridge) of the measuring circuit. These are attached

to an insulated block at an I-frame base which, in turn, acts as a heat sink. The free ends of the wires are soldered to the stranducer terminal board.

The four wires are looped over the hub section of a horizontal torsion pivot. The pivot provides a true turning radius for precise operation. An arm, attached to the hub, is driven by a cable linked mechanically to the balancing motor through two stages of drum and sector reductions. Any change



VP James S. Locke (L) and J. S. Robinson, Divisional Sales Mgr., inspect Stranducer, the electro-mechanical "heart" of the new measuring system.

New Thermoelectric Applications



Ten-watt, gas fired TE generator is used for cathodic protection.

NEW thermoelectric materials which can convert heat energy to electrical energy with practical efficiencies are being studied for a variety of potential applications.

Thermoelectric generation results when one junction of a loop of two dissimilar conductors is heated. A potential difference, the Seebeck effect, is built up. When current is sent through the loop, the opposite effect is created—one of the junctions is cooled and the other heated.

Although the principles have been known for some time, application has been limited to safety devices and for accurate temperature measurement.

Several semiconductor materials have been discovered recently which give higher thermoelectric efficiency and scientists have been applying the new devices to many new fields.

Research and corrosion engineers at Northern Illinois Gas Co., Bellwood, Ill., are studying the use of a TE generator for cathodic protection of gas mains. By tapping a gas main to provide heat energy, and installing a thermoelectric generator for the electrical energy required for mitigation of corrosion, they hope to furnish electrical current at a reduction in cost.

They have installed a 10-w TE generator on an experimental basis. The unit was designed and built by Minnesota Mining and Manufacturing Co., 900 Bush Ave., St. Paul, Minn.

Cathodic protection procedures require a low voltage direct current. Thermoelectric generators appear, therefore, to be suited to this application, as their output is d-c in the desired voltage range.

The energy cost, even at the present stage of development, is comparable to or less than the cost of purchased electrical energy, excluding investment charges in both cases.

A second application is to a problem which goes back to the earliest recorded history—providing effective navigation aids to maritime vessels.

A 10 watt propane fueled thermoelectric generator has been delivered to the U. S. Coast Guard by 3M as part of a feasibility study on the use of thermoelectric power in lighted buoys and other navigation aids. Other devices are also under study.

Most U. S. buoys and other minor navigation aids are now battery powered, delivering about 10 watt hours for each pound of batteries. By contrast, the 12 volt generator

as Rebalancing Element

in position of the balancing motor causes torsional movement of the pivot.

A change in input to the system drives the motor in one direction or the other increasing tension on two of the wires and decreasing it on the other two. This changes the electrical resistance of the wires electrically rebalancing the bridge.

The new potentiometer is called the ElectroniK 17. It can be mounted in a standard 19-in. relay rack, and consists of single pen

strip and circular chart recorders and a circular scale indicator. Features: Isolation of all critical components within an electrical shield; one true reference

junction compensation for all types of thermocouple actuation; and transistorized plug-in control units up to a max. of 8 set points for auxiliary or zone control.

strip and circular chart recorders and a circular scale indicator.

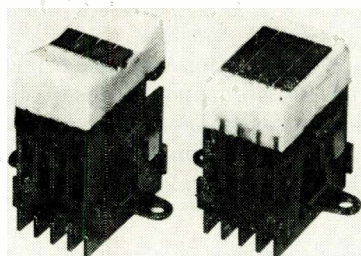
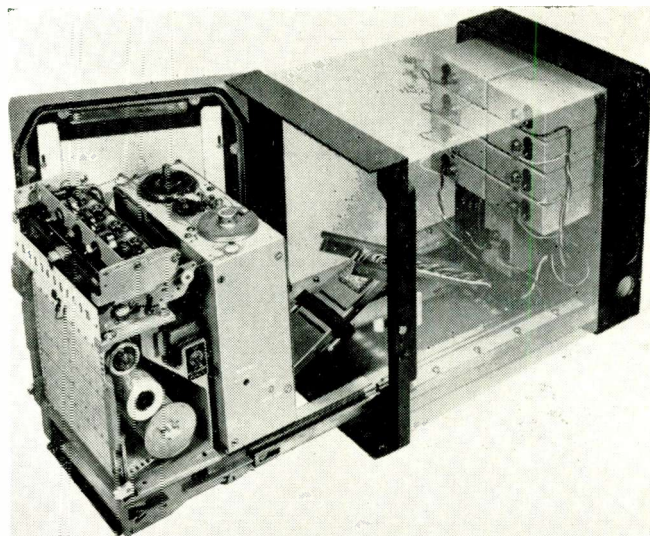

Thermoelectric cooler for small cooling jobs.

just delivered will deliver 200 watt hours for each pound of propane fuel. While present costs range from \$6.00 to \$10.00 per kilowatt hour (from \$33 to \$504 a year for each buoy depending on the size) the fuel cost of a TE generator would be about 15 cents per kilowatt hour. The total cost of a thermoelectric system would be only a small fraction of the cost of present devices.

The Coast Guard hopes to develop a system which will provide uninterrupted power, without maintenance, for a two-year period.

A third application is a thermoelectric spot cooler, offering application flexibility for a variety of small cooling jobs.

The 3M brand thermoelectric spot cooler Model 10 is a ruggedly built unit with a simple, but efficient design, providing practical

thermoelectric cooling for commercial applications.

Two basic models available differ in the types of cold shoe contacts offered. Model 10-J has concave cooper cold shoes, for cylindrical surfaces; Model 10-L has flat copper cold shoes for application to flat surfaces.

Cooler is made up of 4 sets of thermoelectric couples, each couple consisting of a cold shoe, a P and an N element, and a copper cooling

fin. The couples and the cold shoe contacts are embedded in a closed cell foam epoxy for physical strength and moisture protection, with the fins protruding for cooling. The cooler can be operated at amb temps to 250°F.

For extensive heat loads, two or more spot coolers can be applied to one device. It is designed so additional couples and cooling fins may be added to increase the capacity of the module.

Coast Guard is studying this Thermoelectric Generator (by 3M) for use in navigational aids.

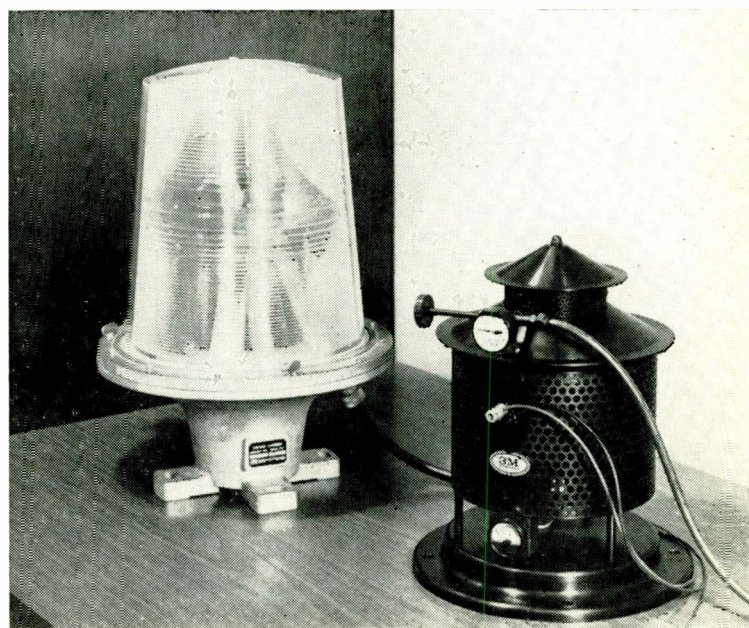

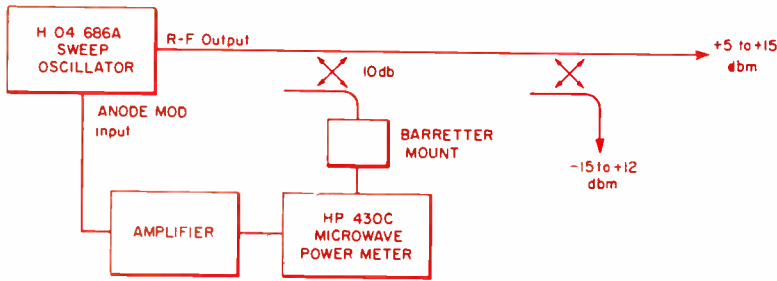

Fig. 1: Block diagram shows the microwave power regulator set-up.

By R. B. MOSLEY

Sylvania Electric Products Inc.
Special Tube Operation
Mountain View, Calif.

Power Regulator for

WITH the advent of the backward-wave oscillator, a number of microwave signal generators with swept frequency outputs have become available. These instruments have made it much easier to measure the characteristics of microwave devices as a function of frequency. For example, a point-by-point plotting which formerly took hours can now be accomplished in minutes, or even seconds.

Important information which could have been overlooked when it occurred between measuring points is now produced as a matter of course. Sweep oscillators lend themselves readily to various methods of data

presentation, ranging from rapidly recurring sweeps suitable for an oscilloscope display, to a single sweep requiring several minutes for recording minute details of frequency response.

As valuable as these new instruments are, they have one drawback which seriously impairs their usefulness—power output does not remain constant as the frequency is varied. The power variation can be as much as 20 db from one end of the frequency range to the other. Even the best instruments operating over an optimum range can have 3 db variation in power level. The problem has been solved by several manufacturers

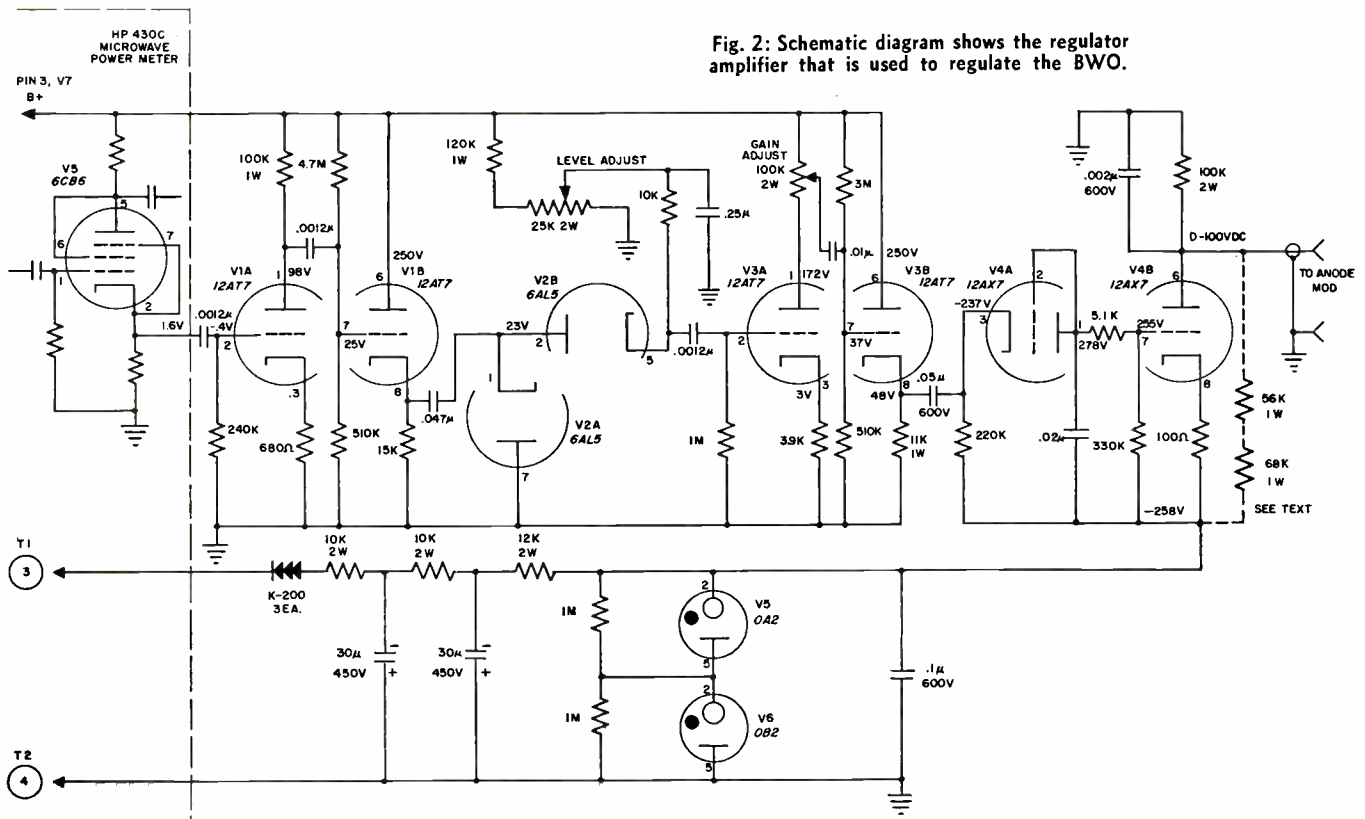

Fig. 2: Schematic diagram shows the regulator amplifier that is used to regulate the BWO.

BWO microwave signal generators with swept frequency outputs are very useful for testing microwave devices. However, they have one drawback—power output varies with frequency. Here is a simple, inexpensive method of overcoming this problem.

A REPRINT
of this article can be obtained by
writing on company letterhead to
The Editor
ELECTRONIC INDUSTRIES
Chestnut & 56th Sts., Phila. 39, Pa.

BWO Sweep Generators

by using a leveler, or degenerative feedback system that controls the power output of the backward-wave oscillator. These levelers are usually quite expensive.

The power regulator described here is also of the degenerative feedback type.¹ Since it uses components which would probably be used in any event—namely, a directional coupler, a barretter mount, and a microwave power meter—the additional cost of the regulator is very low. The system being described here was designed to use a Hewlett Packard H 04 686A Sweep Oscillator as the signal source and a Hewlett Packard 430C Microwave Power Meter as part of the regulator.

The H 04 686A Sweep Oscillator has a frequency range of 7 to 11 KMC and a minimum power output of 30 milliwatts. The power regulator operates from 8 to 11 KMC and the r-f output can be held within 0.25 db of any preset level from -15 dbm to +12 dbm or within 1 db at levels up to +15 dbm, over the operating frequency range.

A similar regulator system could be used with other Hewlett Packard Sweep Oscillators to obtain like results in other frequency bands. With slight modifications it could be made to work with any sweep oscillator whose anode or grid circuit is adaptable for external control.

Regulator Operation

A block diagram of the regulator system is shown in Fig. 1. The output of the sweep oscillator is sampled through a 10 db waveguide directional coupler and the sampled power is measured with a barretter connected to the 430C Microwave Power Meter. The power meter contains a self-balancing bridge and a 10.8 KC audio oscillator. The application of r-f power causes an increase in the temperature of the barretter element. The power meter automatically reduces the amplitude of the 10.8KC audio oscillator to keep the temperature of the barretter constant and thus keep the bridge in

balance. The amplitude of the audio signal is therefore inversely proportional to the r-f power.

The audio signal is sampled at the cathode of the final amplifier tube in the power meter, and the sample is fed to the input of the regulator amplifier as shown in Fig. 2.

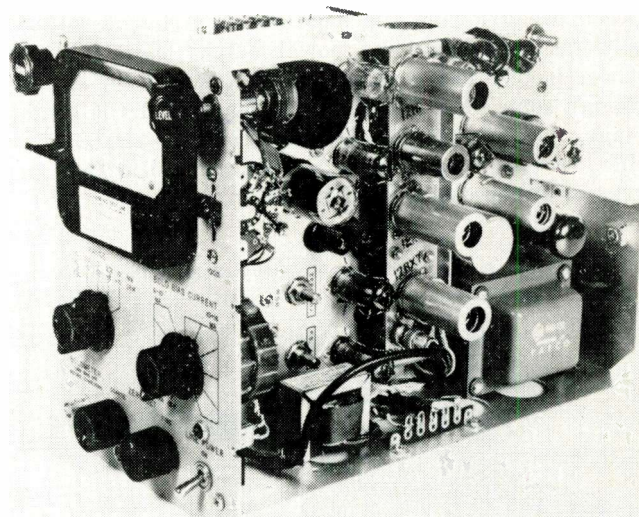

Fig. 3: Regulator amplifier is mounted in center of power meter.

After the signal passes through the first amplifier stage and a cathode follower, the negative portion is clipped and discarded. The remaining signal is clipped again and the positive peaks are retained. The clipping level in this stage is adjustable by means of the Level control. For any given gain control setting, the amount of signal out of this clipper determines the magnitude of the dc feedback voltage, and therefore the level of the r-f output from the backward-wave oscillator.

After the second clipper the signal is amplified

1. The original design for this regulator was developed at the Waltham, Massachusetts, laboratory of Sylvania Electric Products, Inc.

BWO Regulation (Continued)

again and a phase reversal takes place. The negative pulses thus obtained go through the Gain control to another cathode follower. The cathode follower output is rectified and the negative dc voltage is applied to the grid of the final amplifier tube. Another phase reversal takes place in this stage. The positive side of the plate supply for this tube is grounded, thereby providing a negative output voltage which is connected to the Anode Mod. jack on the Hewlett Packard H 04 686A Sweep Oscillator. When the Anode Mod. Selector switch on the sweep oscillator is in the Ext. position, this negative dc voltage is superimposed on the BWO anode voltage as set by the sweep oscillator Cathode Current control. The net anode voltage determines the cathode current and thus controls the r-f power output of the backward-wave oscillator.

Modification for Grid Modulation

Later models of Hewlett Packard sweep oscillators have had the anode modulation feature replaced by grid modulation. To work with a sweep oscillator of this type, a slight modification of the feedback amplifier output is necessary. The BWO in this type of sweep oscillator has a clamping diode connected from grid to cathode. A 300 volt power supply in series with a resistance of 150,000 ohms provides a current of 2 ma. through the diode to keep the grid clamped at cathode potential. In order to drive the grid negative and thereby control r-f power output, another path must be provided for this diode current. This can be done by connecting approximately 125,000 ohms between the grid and the negative terminal of the 250 volt gas tube regulated power supply built into the power meter. This connection is shown in Fig. 2. Although some gain is lost due to loading of the output stage, the regulator amplifier has ample gain to offset this loss and the system works equally well with either type of sweep oscillator modulation.

Fig. 4: Level and Gain controls are mounted alongside of meter.

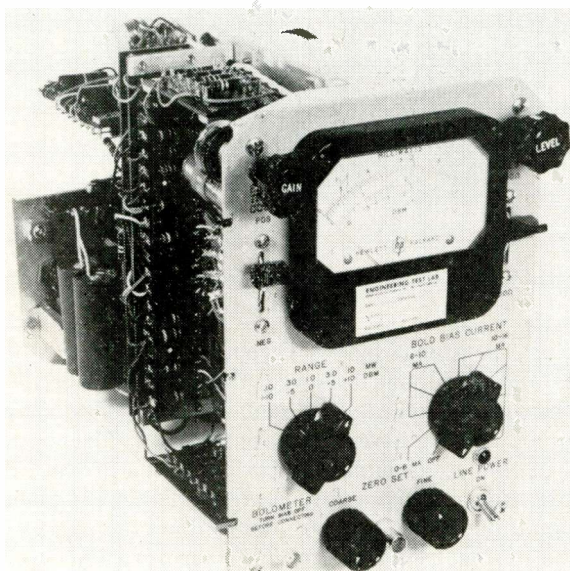

REFERENCE PAGES

The pages in this section are perforated for easy removal and retention as valuable reference material.

SOMETHING NEW HAS BEEN ADDED

An extra-wide margin is now provided to permit them to be punched with a standard three-hole-punch without obliterating any of the text. They can be filed in standard three-hole notebooks or folders.

The regulating action of the system can be described briefly in the following manner. An increase in power output from the backward-wave oscillator reduces the amplitude of the audio oscillator signal in the power meter. This results in a decrease in the amplitude of the negative peaks applied to the rectifier tube in the regulator amplifier. The grid voltage on the final amplifier tube becomes less negative and the plate therefore becomes more negative. This increase in negative voltage is then applied to the anode (or grid) circuit of the backward-wave oscillator, reducing the cathode current and returning the r-f power to its original level.

The regulator amplifier is built on a small sub-chassis and mounted directly on the chassis of the power meter. Its operating voltages are obtained from the power meter B+ supply and from a gas tube regulated supply and two filament transformers added to the power meter chassis. The control knobs are mounted on the power meter panel. The locations of the regulator amplifier sub-chassis and the control knobs are shown in Figs. 3 and 4.

Sources of Error

Several sources of error should be considered when using a regulator of this type. Some of these are inherent in the components which are used to make up the system and are normally accounted for in some manner even when the power level is not regulated. Other errors are peculiar to the regulator system itself. The latter errors are quite small and for most purposes can be ignored.

One of the errors inherent in the components is due to the impedance match of the barretter mount. If the match is frequency sensitive, power output will vary with the frequency even though the power meter reading remains constant.

Another source of error is the variation with frequency of the coupling factor in the directional coupler. Since the power is held constant at the barretter on the output of the auxiliary guide, any variation in coupling factor will cause a corresponding variation in the main guide. This error can be largely overcome, with a sacrifice in power level, by taking the useful power from the auxiliary guide of a second directional coupler and terminating the main guide. As long as the variations in coupling factors of the two couplers are well matched, the errors will very nearly cancel, resulting in almost constant useful power output.

When the frequency of the sweep oscillator is adjusted manually, a frequency error is introduced by the power regulator system. The frequency dial of the sweep oscillator controls helix voltage and is calibrated at a constant cathode current. When the cathode current is reduced by the action of the regulator cir-

cuit, the BWO frequency is also reduced by a small amount which depends on the amount of change of cathode current. Since the power output of the unregulated H 04 686A Sweep Oscillator increases as the frequency is lowered, the regulator must cause an increasing change in cathode current as the frequency is lowered. The result is a greater frequency error at lower frequencies. The magnitude of the error also depends on the power level which the regulator maintains, again because the power level is determined by cathode current.

The actual frequency error in the system tested varied from practically zero at 11.0 KMC and an output of +13 dbm to 0.5% at 8.0 KMC and +5 dbm (-15 dbm at the auxiliary guide of a 20 db directional coupler). The dial calibration error was no greater than 0.3%, making the maximum total error

less than the advertised maximum of 1% for the unregulated sweep oscillator.

Since no specification is given concerning the linearity of the swept frequency versus time, no attempt was made to determine the amount of additional error in this characteristic caused by the effect of the regulator on frequency. It is apparent from the test results, however, that the error will be very small and will appear as a slight increase in sweep rate.

The microwave power regulator described here has proved to be a useful and relatively inexpensive addition to the test equipment in the Mountain View Components Laboratories of Sylvania's Special Tube Operation in Mountain View, California. Some twenty of these units have been constructed with various modifications and have given satisfactory performance for several years.

Fig. 1: Workpieces to be fired are cathode support insulators for microwave amplifier electron tubes.

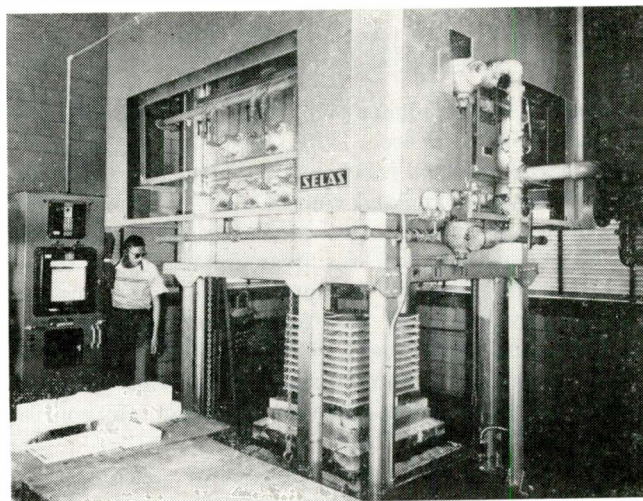

Gradiation Method Fires Components*

FIRING steatite ceramic parts, used in electron tubes, to high temperatures, and effecting changes in their composition, entails critical time-temp. relationship and control. In transforming the fragile, unfired powder preform to finished ceramic form, electrical characteristics must be precisely developed. The ceramic pieces must be fired to exact dimensions and density.

Western Electric Allentown (Pa.) Works has perfected this operation using a Gradiation periodic kiln (Fig. 1). The heating unit was designed and built by Selas Corp. of America, Dresher, Pa., to fire ceramic piece parts such as cathode support insulators for microwave amplifier tubes and structural members for other electron tubes. As many as 12,000 pieces at a time can

be *uniformly* heat processed in this kiln with a minimum of rejects.

Heating-Operation

The ceramic parts are composed of talc, kaolin, barium and magnesium carbonates (See Fig. 2). They must be fired at temps from 2280° F to 2320° F, the exact temp depending on the forming technique that precedes the heating process—i.e., whether formed by powder press, extruder, or slug press.

Fig. 2: Ceramic parts are composed of talc, kaolin, barium, and magnesium carbonates.

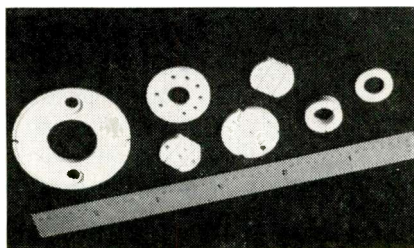

Once formed, the ceramic parts are transported to the Selas kiln and approximately 12,000 of them loaded onto 36 or 40 mullite firing plates. The plates are arranged four on a level and stacked 9 to 10 plates high (See Fig. 3).

The Duradiant burners on each of the 4 walls are lighted, stabilized, and the elevator car is raised to position in the kiln.

The heating operation proceeds as shown in chart, Fig. 4. A scheduled time of approx. 4½ hr is allowed to bring the kiln heating chamber up to the desired temp, between 2280° F and 2320° F. A soaking period of 5 hr at the preset temp is then maintained with accuracy, not varying more than ±10° F, and radiant heat is distributed uniformly throughout the entire 12,000 - ceramic - piece workload.

(Continued on page 182)

* Abstracted from a paper by Gordon D. Smith, Application Engineer, Furnace & Kiln Div., Selas Corp. of America, Dresher, Penna.

Theory, confirmed by experiments, indicates that magnetic memory techniques may be employed to provide features unobtainable with conventional AFC and APC systems. Though still experimental, the techniques are presented here.



M. Cooperman

Controlling With Magnetic

AUTOMATIC frequency control (AFC) and automatic phase control (APC) maintain a fixed frequency and phase relationship between a locally generated waveform and some chosen reference. The waveform generator is an oscillator; the reference, a signal coming from the transmitter or a tuned circuit in the receiver. Examples of such systems are the AFC system used in FM receivers to keep the station tuned,¹ and the APC system used in TV to obtain horizontal scanning synchronization.² A complete study of the basic theory of automatic control can be found in Ref. 3.

Some of the most important performance characteristics of AFC and APC systems are (1) range of control; (2) accuracy of control; (3) speed of control, and (4) noise immunity which is the ability of the system to function in the presence of noise. The degree to which (2), (3), and (4) can be obtained depends on the control range which must be large enough to accommodate the probable frequency drift in the oscillator.

This article shows how a magnetic memory can be used to correct the drift in oscillator frequency and thereby make it possible to design these systems for improved performance.

Conventional AFC System

The operating principle of a conventional AFC system, in conjunction with a superheterodyne receiver, is shown in Fig. 1. The local oscillator is controlled to maintain a constant difference between its frequency and the frequency of the incoming r-f carrier. Thus, assuring that the difference frequency

will have the correct location within the frequency spectrum of the i-f passband. Here's how its done.

Part of the i-f output goes through a frequency discriminator having a characteristic as shown in Fig. 1. If the difference frequency is not equal to the frequency where the discriminator crosses the zero axis (this is the value at which it is desired to maintain the difference frequency), a dc voltage is produced which is indicative of the magnitude and polarity of the frequency error. This voltage is passed through a low-pass filter. The filter output is used to control a reactance device which in turn controls the oscillator frequency. Consequently, if the oscillator frequency error without AFC had been Δf (see Fig. 1), the AFC loop would reduce this error to $\Delta f'$

The relation⁴ between Δf and $\Delta f'$ is

$$\Delta f' = \frac{\Delta f}{1 + K} \quad (1)$$

where K is the open loop gain which, with the AFC loop open at point A,

Fig. 1, may be defined as

$$K = \frac{\text{L. P. filter output voltage}}{\text{reactance input voltage}} \quad (2)$$

To produce a significant frequency correction, K must be much larger than unity. Then

$$\Delta f' \cong \frac{\Delta f}{K} \quad (3)$$

By examining Eqs. (1) to (3), certain conclusions can be drawn regarding the performance of the system.

First, Eq. (3) shows that to keep $\Delta f'$ within some specified limits, an increase in Δf requires a proportional increase in K . However, design and cost considerations limit the maximum value of K .

Second, according to Eq. (2), K is proportional to the low-pass filter output which decreases as the incoming r-f signal strength decreases. Consequently, $\Delta f'$ will change with the r-f signal strength when

A REPRINT

of this article can be obtained by writing on company letterhead to
The Editor
ELECTRONIC INDUSTRIES, Chestnut & 56th Sts., Phila. 39, Pa.

By **MICHAEL COOPERMAN**

*Electrical Engineer
RCA Victor Home Instruments Div.
Advanced Development Engineering
Cherry Hill, Camden 8, New Jersey*

Cores

there is no limiting or AGC action.

Third, if reception is momentarily interrupted, which may be caused by an atmospheric disturbance, K becomes zero, since the output of the low-pass filter is zero. Then, according to Eq. (1), $\Delta f'$ becomes equal to Δf . When the signal is received again, it takes the system more time to reach a steady state, i.e., to reduce Δf to $\Delta f'$, than it would had the system been at $\Delta f'$.

AFC System with Magnetic Memory

Fig. 2 shows the conventional system of Fig. 1 with the reactance device replaced by a transfluxor magnetic memory core^{5,6} and associated circuitry. The properties of the transfluxor are such that the inductance of winding W_2 , which controls the oscillator frequency, is a function of the amount of magnetic flux present in the core. To produce a flux requires a current of sufficient magnitude in W_1 . But once a certain flux is established, no external current or energy is required to maintain it. This is illustrated in Fig. 3 which shows the flux in the core of Fig. 2 as a function of the current in W_1 . The points designated by state A and state B indicate the presence of a flux even though the current in W_1 is zero.

Referring again to Fig. 2, if the

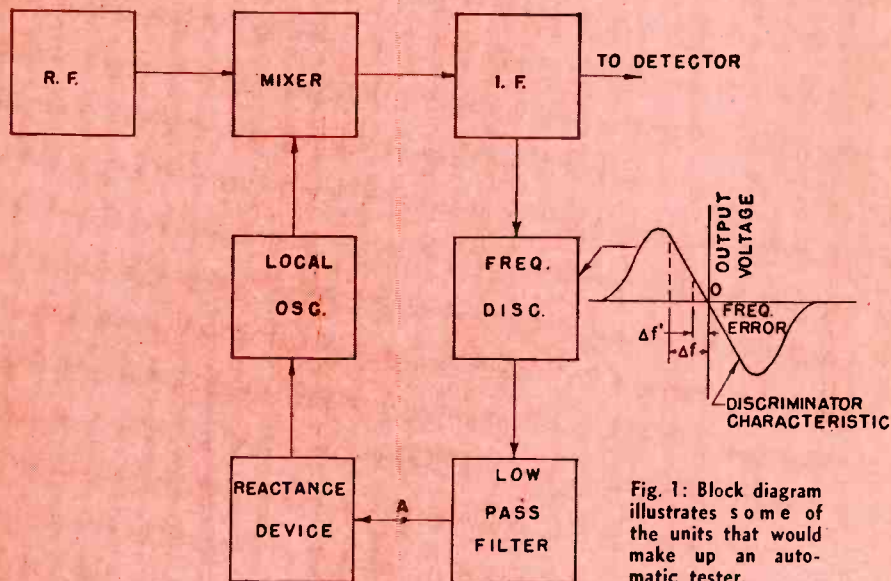

Fig. 1: Block diagram illustrates some of the units that would make up an automatic tester.

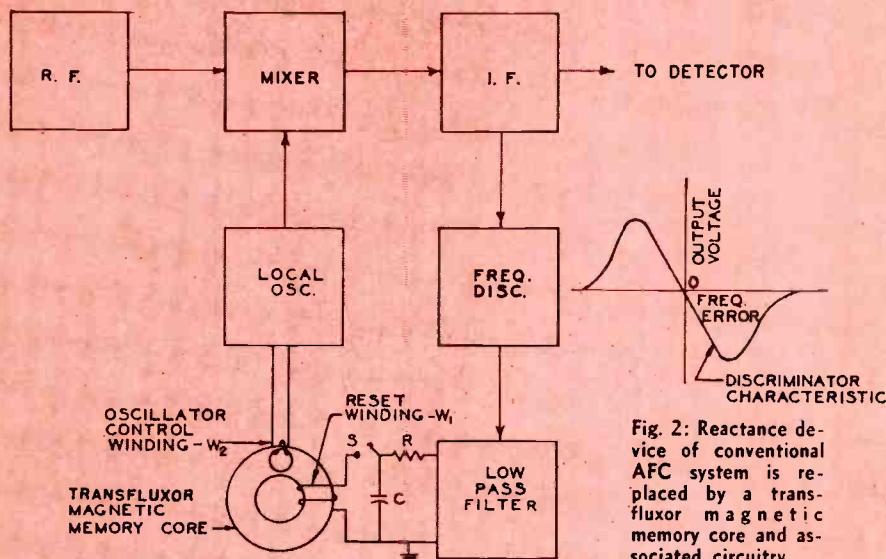

Fig. 2: Reactance device of conventional AFC system is replaced by a transfluxor magnetic memory core and associated circuitry.

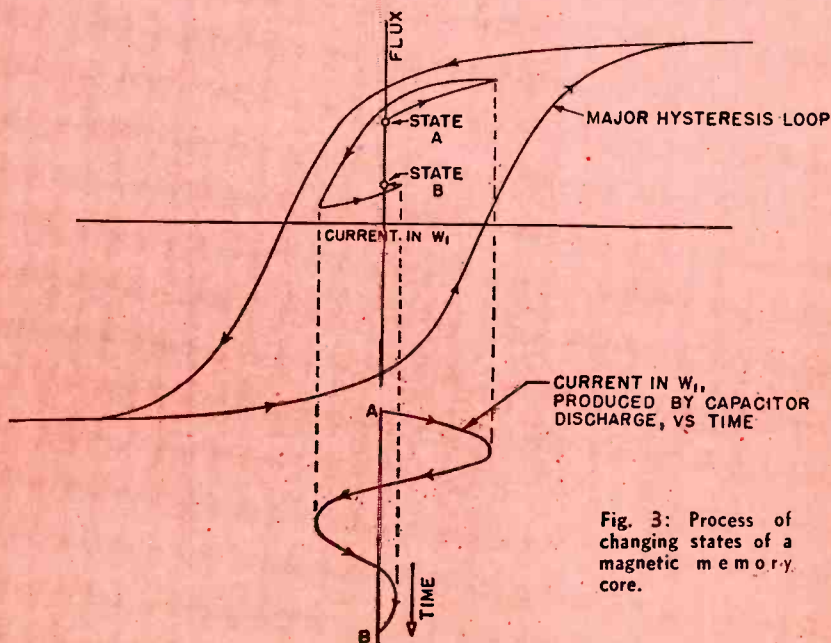

Fig. 3: Process of changing states of a magnetic memory core.

Magnetic Memories (Concluded)

oscillator is off in frequency, the discriminator puts out a voltage which charges capacitor C through resistance R. Switch S closes and opens repeatedly at a controlled and predetermined rate. During the time interval when the switch is open, capacitor C charges to a value equal to the error voltage. When the switch closes, the capacitor quickly discharges through W_1 , producing an exponentially decaying current oscillation in that winding.

The current in W_1 causes the memory core to move from some state A to some state B along a path indicated by the arrows, Fig. 3. This produces a change in inductance of W_2 with a corresponding change in oscillator frequency.

If this new oscillator frequency is still not at the correct value, the next capacitor discharge will again change the oscillator frequency. This process continues until, partly by chance, the core gets into a state which makes the oscillator frequency correct and the discriminator output goes to zero. Although switch S continues to function, the core state cannot be changed since the capacitor has zero charge.

The process of arriving at the correct frequency is not completely random, since the magnitudes of the capacitor discharges become progressively smaller as the correct oscillator frequency is approached. The speed of correction depends on the rate at which the switch operates.

Once the system has arrived at the correct frequency, the AFC loop can be opened or the r-f signal can be removed without changing the oscillator frequency. In effect, the oscillator has been permanently

Fig. 4: AFC system with magnetic memory and transistor switch.

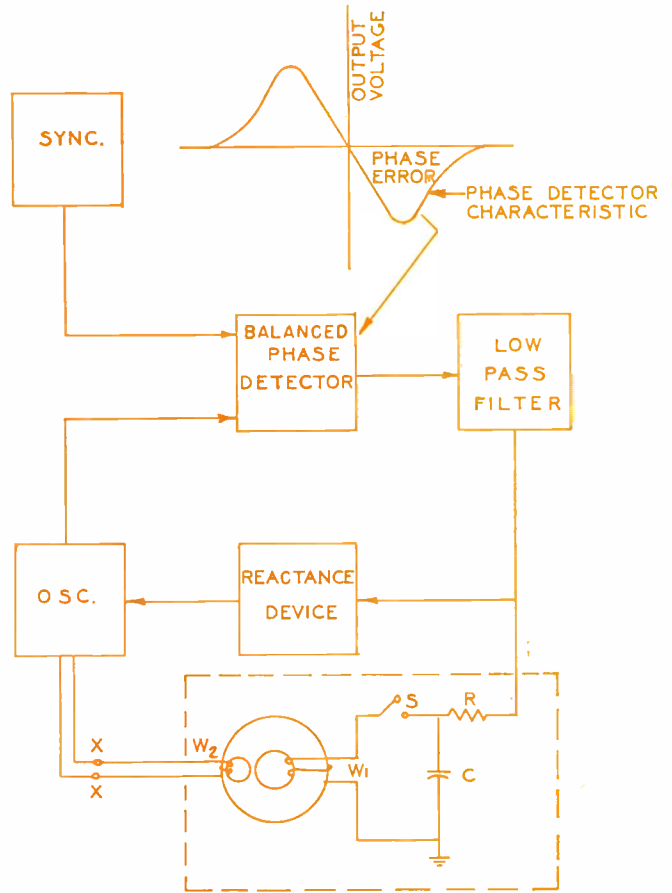
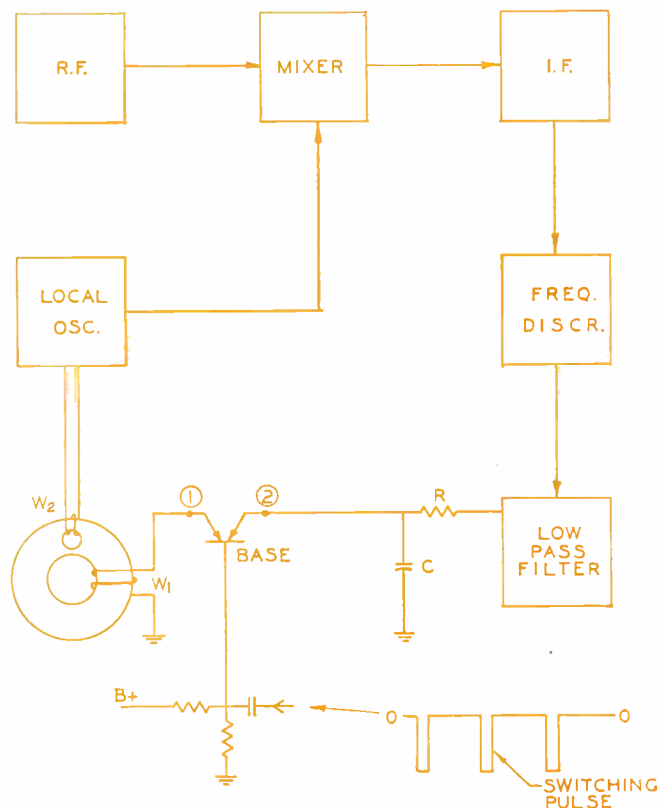

Fig. 5: Automatic phase control system with magnetic memory.

returned to the right frequency and does not require the presence of an error voltage unless it is still drifting.

This system, since it no longer needs the error voltage to maintain the corrected frequency, is not troubled by a change in signal strength or absence of signal. The amount of final error ($\Delta f'$) decreases as K is increased, but bears no relation to the initial error (Δf). Therefore, the control range, which is a function of the inductance range of winding W_2 , can be increased without requiring additional loop gain.

Experimental AFC Circuit

Fig. 4 shows the AFC system of Fig. 2 with switch S replaced by a transistor having a bilateral characteristic. This type of transistor, when it is made to conduct, permits the flow of current from 1 to 2 or from 2 to 1, as indicated in Fig. 4. The base of the transistor is normally biased sufficiently positive so that points 1 and 2 are effectively disconnected and capacitor C is charged to the error voltage. The transistor is turned on at regular intervals by negative pulses applied to its base through a capacitor. During the time interval of a negative pulse the base becomes negative and the transistor provides a practical short circuit between points 1 and 2, and the capacitor discharges through W_1 . Thus the transistor performs the function of switch S in Fig. 2.

This circuit is particularly practical in a TV receiver where pulses at vertical (60 cps) and horizontal (15,750 cps) rates are readily available to be used for transistor switching.

Conventional APC System

Fig. 5, with terminals x-x disconnected, is a conventional APC system. The oscillator wave is compared with the synchronizing wave in a phase detector whose output is applied to a reactance device through a low-pass filter. The reactance device so tunes the controlled oscillator as to frequency-synchronize it with the controlling wave.

Although frequency synchronization is established, the relative phase between the two waves can assume many values, depending on the amount of oscillator retuning required for frequency-synchronization. The amount of retuning is the difference between the synchronizing frequency and the free-running oscillator frequency.

The relative phase at steady-state can be expressed as

$$\sin \Delta \phi = 2 \pi \frac{(f_s - f_o)}{K} \quad (4)$$

where

$\Delta \phi$ = the relative phase between the synchronizing and controlled waves,

f_s = the fundamental frequency of the synchronizing wave,

f_o = the fundamental frequency of the free-running oscillator wave,

$$K = \frac{\text{phase detector output voltage}}{\Delta \phi} \times \frac{\text{change in } f_o}{\text{reactance input voltage}}$$

For small values of $\Delta \phi$, which are dealt with here, $\sin \Delta \phi$ can be approximated by $\Delta \phi$ and

$$\Delta \phi \cong 2 \pi \frac{(f_s - f_o)}{K} = 2 \pi \frac{\Delta f}{K} \quad (5)$$

If f_o is allowed to drift, $\Delta \phi$ does not remain constant. According to Eq. (5), the variation in $\Delta \phi$ can be reduced by increasing K . However, the noise immunity of the system decreases if K is increased.⁷ Thus, conventional APC systems present a problem

Fig. 6: Horizontal TV oscillator phase control using magnetic memory.

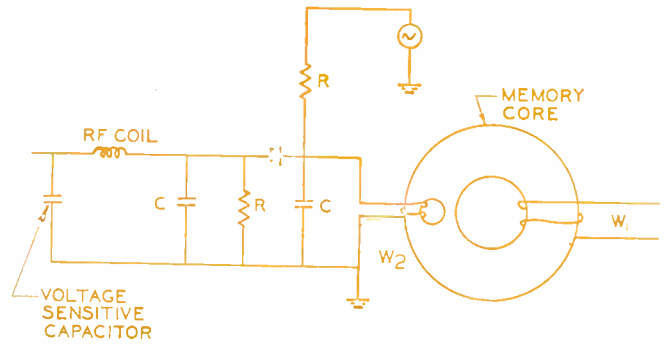
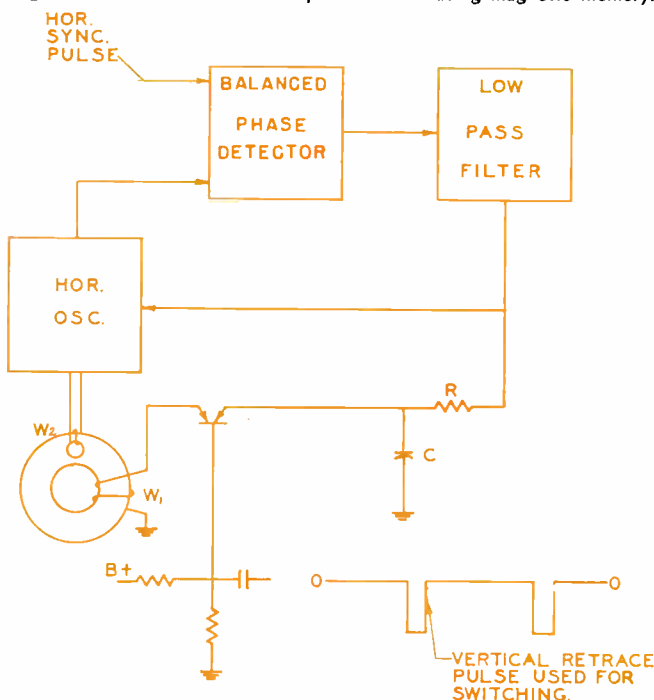

Fig. 7: Circuit for using an inductance memory at very high frequency.

when the noise immunity and phase accuracy have to be optimized.

APC System with Magnetic Memory

One way of improving the phase accuracy without affecting other performance characteristics of the system is to reduce Δf , the amount by which the oscillator is allowed to drift. This can be done by using a magnetic memory core and associated circuitry to correct drifts in oscillator frequency. Fig. 5, with terminals x-x connected, adds such a memory core loop to the conventional APC system.

The oscillator frequency is controlled in a way similar to that in AFC. Here the error voltage is produced by a phase detector whose output is indica-

REFERENCE PAGES

The pages in this section are perforated for easy removal and retention as valuable reference material.

SOMETHING NEW HAS BEEN ADDED

An extra-wide margin is now provided to permit them to be punched with a standard three-hole-punch without obliterating any of the text. They can be filed in standard three-hole notebooks or folders.

tive of the magnitude and polarity of the phase error. The phase detector output is used to reset the memory with the same technique employed in AFC. When the oscillator drift is corrected so that the phase error becomes zero, the detector output is also zero and the state of the core is no longer disturbed.

Besides improving the phase accuracy without deteriorating the noise immunity, the addition of the memory loop to the conventional APC system provides the following features:

7. Since the oscillator has, in effect, been permanently retuned to reduce Δf and $\Delta \phi$, the synchronizing signal can be removed or the loop opened, and the oscillator frequency would remain at its corrected value which is very nearly f_s . Under similar conditions, a conventional system would return to its uncorrected frequency f_o . This is significant where time required for synchronization is to be kept at a minimum since this time increases with the difference between f_o and f_s .

2. Since the phase correction is obtained by permanently retuning the oscillator, the hold-in range can be increased by increasing the inductance range of W_2 . The hold-in range is the maximum permissible variation in f_s required to maintain synchronization.

Magnetic Memories (Concluded)

3. By using a system with a balanced phase detector, Fig. 5, the pull-in range can be increased by increasing the inductance range of W_2 . The pull-in range is the maximum permissible variation in f_s required to establish synchronization.

Application

One area where the magnetic memory finds immediate application is in horizontal oscillator phase control in TV receivers, Fig. 6. This is an APC system whose basic mode of operation was just described. Here the controlled wave is produced by a blocking oscillator whose frequency can be controlled by changing the oscillator grid bias.

Since the oscillator can be controlled directly, the reactance device is not required and the output of the low-pass filter is applied directly to the oscillator grid. The controlling wave is horizontal sync. The memory core is operated by a transistor switch which is turned on by the vertical retrace pulse. The core is therefore receiving correcting information every field, during a time when the picture is blanked out.

Use of Magnetic Memories at VHF

In the AFC and APC systems described, the magnetic memory provides an inductance memory which is used directly in the oscillator as a frequency-controlling element. This method is satisfactory up to frequencies in the order of 50 MC. Above this frequency the core losses of presently available magnetic materials are too high to permit their direct use in the oscillator circuit.

By adding additional circuitry to the system, the magnetic memory can be used above 50 MC. Fig. 7 shows the memory portion of the AFC or APC system. The inductance of W_2 and C form a parallel-tuned circuit which is fed from an auxiliary ac source of 15,750 CPS. This frequency is chosen since it is readily available in a TV receiver; however, frequencies up to a few megacycles can be used.

The parallel-tuned circuit is adjusted so that 15,750 CPS falls somewhere on the slope of its response characteristic. Consequently, as the core setting changes the inductance of W_2 , the tuning and the output of the tuned circuit also change. The ac output of the tuned circuit is peak-detected and used to control the capacity of a voltage-sensitive capacity diode. Thus, a change in the inductance of W_1 is translated into a change in capacity which can control the oscillator at VHF.

References

1. F. Lanford-Smith, *Radiotron Designer's Handbook*, 4th Ed., ch. 28, pp. 1150-1160, 1952.
2. Donald G. Fink, *Television Engineering*, 2nd Ed., pp. 207-214, McGraw-Hill Book Co., Inc., 1952.
3. Gordon J. Murphy, *Basic Automatic Control Theory*, D. Van Nostrand Co., Inc., Princeton, N. J.
4. E. E. epler, *The Technique of Radio Design*, p. 121, Chapman and Hall, London 1943; John Wiley and Sons, New York, 1943.
5. J. A. Rajchman and A. W. Lo, "The Transfluxor—a Magnetic Gate with Stored Variable Setting," *RCA Review*, vol. 16, pp. 303-311, June 1955.
6. J. A. Rajchman and A. W. Lo, "The Transfluxor," *Proc. IRE*, vol. 44, No. 3, pp. 321-332, Mar. 1956.
7. Wolf J. Gruen, "Theory of AFC Synchronization," *Proc. IRE*, vol. 41, No. 8, pp. 1043-1048, Aug. 1953.

Part Two of Two Parts

By **THOMAS D. SMITH** and
HARRY R. SPENCE

Members of the Technical Staff
Space Technology Laboratories, Inc.
P. O. Box 95001
Los Angeles 45, Calif.

Designing a Lightweight

RESULTS of this design (Fig. 9) were quite encouraging. Repeatability was greatly improved. Sensitivity at the lower frequency range was approx. 5 mv/g but increased to 10 mv/g at 2000 CPS. As the second and third subharmonics of the mechanical resonant frequency were reached, distortion of the output waveform occurred which could easily cause erroneous evaluations of recorded data if waveform information were not included.

Several of these devices were fabricated and tested, using both an rms voltmeter and an oscilloscope. Sinusoidal excitation was used to drive the vibration table during testing. A Glennite or Endeveco accelerometer was used to monitor the input in order to maintain a constant amplitude for each frequency run and to assure that the input was sinusoidal. Peak values of the oscilloscope display corresponded with rms voltage readings of the output signal from the test transducers in the absence of distortion. Thus, without distortion, either method was acceptable. To prevent short circuits or noise caused by relative movement, the output leads were taped to the vibra-

Fig. 10: Filter Network.

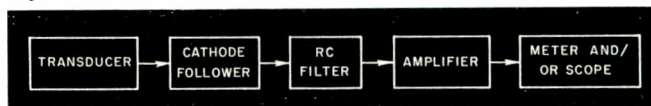

tion table. Although the output distortion was significant at certain frequencies, it remained undistorted over the major portion of the operating frequency range. Since each transducer was fabricated individually, the frequencies causing distortion varied considerably from one to the other. Uniform fabrication would result in a smaller variation of the resonant frequency; however, the degree of accuracy necessary to acquire this was not attained in fabricating the

Special transducers must be developed to handle dynamic measurements of electronic hardware under vibrational environments. These devices should be "Throw-aways" which can be left in the equipment after the measurements are made. Size and weight are also critical since they affect the data. Here is the procedure followed in the development of a satisfactory lightweight transducer for this application.

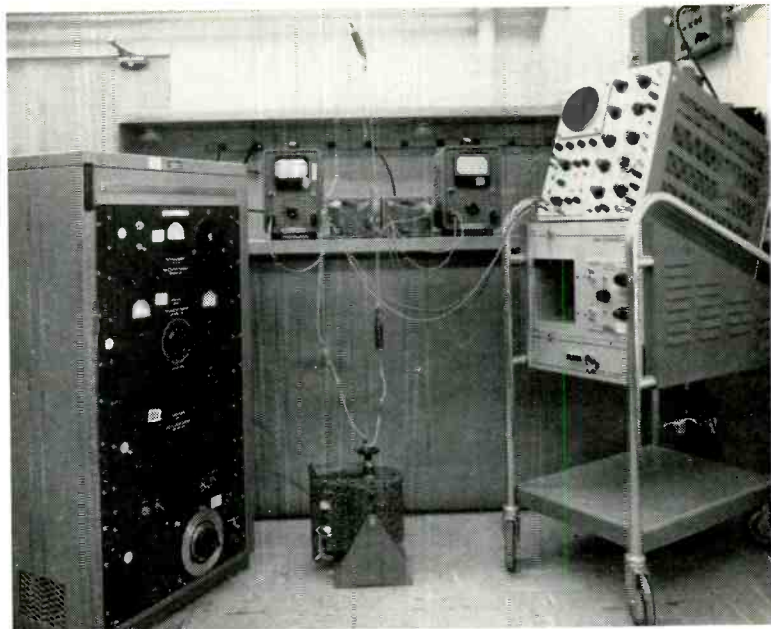

Fig. 12: Vibration exciter used for testing.

Vibration Transducer

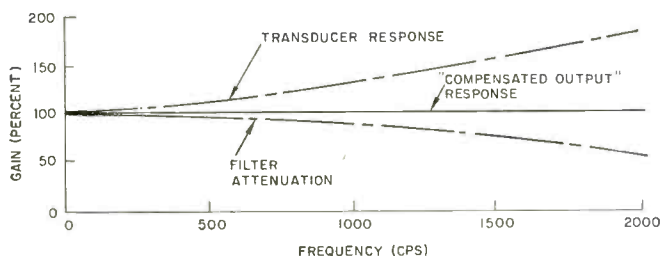

Fig. 11: "Compensated Output" derived from a combination of transducer and filter.

prototypal models. Once the final design is reached, uniform construction can be accomplished through controlled production techniques.

Fig. 6a presents the latest design using an electrostatic shield. This shield was made of copper foil wrapped around the transducer with one lead grounded to the foil. Although this may be desired to filter out objectionable noise levels when the unit is used in or around electrical equipment under operation, the increase in weight may prove to be disadvantageous for certain applications. To decrease the weight of the shield it may be possible to lay a thin metal film deposition on the surface of the transducer.

More Problems

Although results were acceptable within limits, two problems still persisted; first, distortion was significant, and second, the output increased with increasing frequency. It was felt that a filter between the transducer and the recording meter would alleviate the difficulties. Considering the low frequencies, an RC filter was built with these attenuation characteristics:

30 CPS	0% attenuation
1000 CPS	20% attenuation
2000 CPS	50% attenuation

Information from tests on latter transducers was used to arrive at the attenuation necessary. An amplifier was inserted between the filter and the metering equipment, although this is not necessary. The block diagram of this network is shown in Fig. 10. The cathode follower acts as a buffer stage for the transducer output. With an input impedance of approx. 100 megohms, the cathode follower allows a better low frequency response by eliminating the loading effect of the transducer due to the following stage. Fig. 11 is the transducer response, the calculated filter re-

Fig. 13: Details of vibration exciter in Fig. 12.

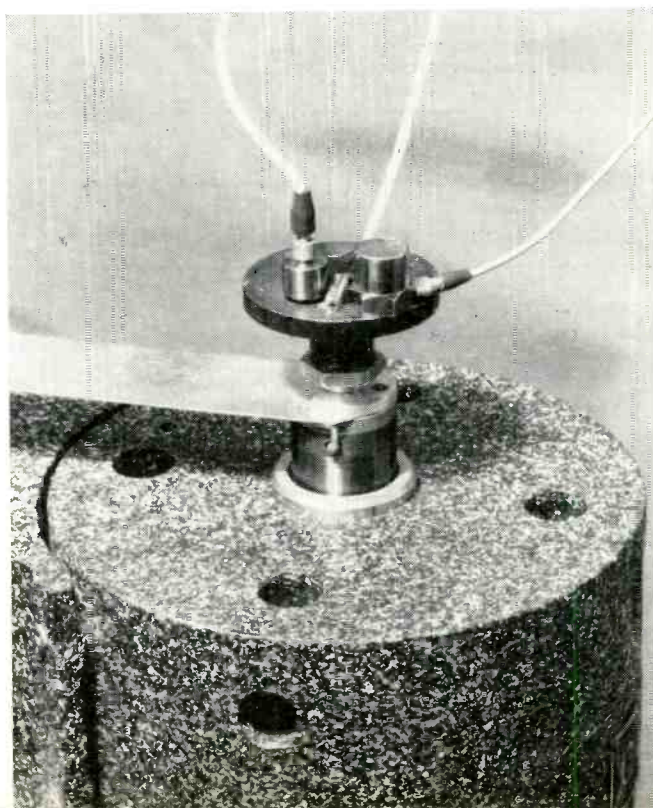

Transducers (Continued)

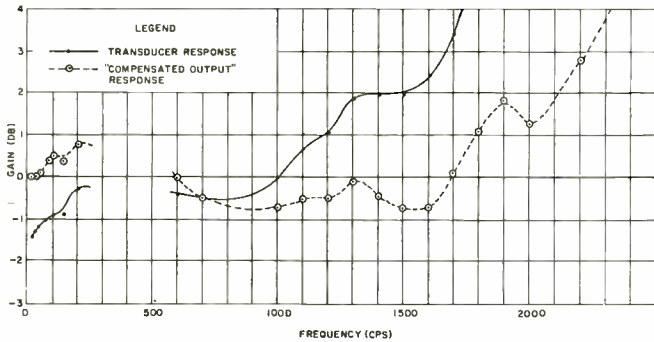

Fig. 14: Comparison of "compensated output" with normal response. Note: irregularities were caused by table resonances.

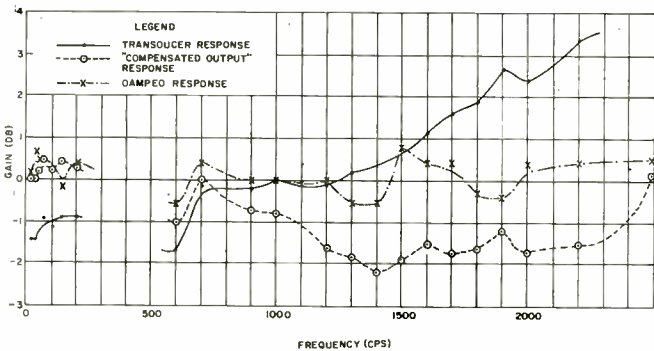

Fig. 15: Response of transducer 1. Irregularities caused by table resonances.

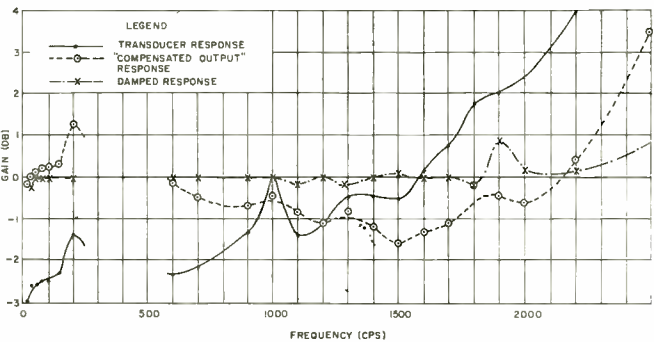

Fig. 16: Response of transducer 2. Irregularities caused by table resonances.

A REPRINT
of this article can be obtained by writing on company letterhead to
The Editor
ELECTRONIC INDUSTRIES, Chestnut & 56th Sts., Phila. 39, Pa.

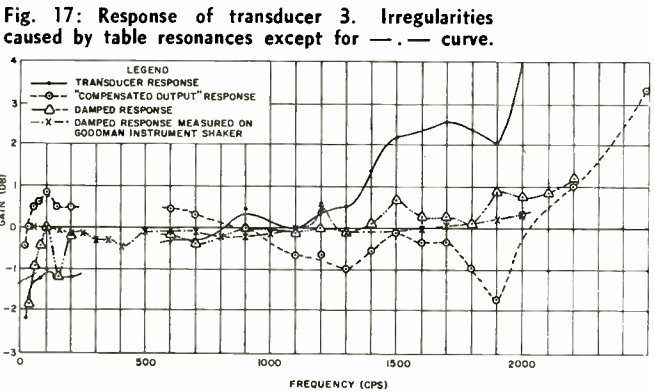

Fig. 17: Response of transducer 3. Irregularities caused by table resonances except for — — curve.

response, and the anticipated response of the combination. At this stage, the output amplitude of the transducer increased twofold between the frequencies of 30 and 2000 CPS. The filter action is shown as having a frequency response in opposition to the transducer. The output, when obtained through this system, will be referred to as the "compensated output" response. Note that Fig. 11 has linear frequency graduations. This was done to increase the graduation scale of the higher frequencies, since it was desired to portray in greater detail the response obtained over this portion of the frequency range. To abate confusion, all subsequent graphs are plotted against a linear frequency scale.

At this point, it was necessary to discontinue using the MB vibration table as the driving exciter. A small vibration exciter was substituted (Fig. 12). Due to its construction, large, objectionable, mechanical resonances occurred between 200 and 600 CPS, consequently invalidating the data in this range. Fairly sharp resonances occurred at other frequencies; this accounts for the rapid variations that may be seen in the data from this shaker. To ensure that the information recorded was obtained at frequencies of min. distortion, and to indicate the resonances that were occurring in the supporting plate, two commercial accelerometers were placed on either side of the test transducer (Fig. 13). The data obtained with the substituted exciter were used to evaluate the favorableness of approach only. Because of the extremely large resonances present, data were not plotted between 200 and 600 CPS.

The curve labelled "compensated output" (Fig. 14) shows that data from the filter network compare favorably with the anticipated reaction. In this figure, the "compensated output" response shows a variation of from -0.8 to $+1.8$ db between 30 and 2000 CPS even though the transducer output increased above $+4$ db. Figs. 15, 16, and 17 show the "compensated output" response low, while in Fig. 18 it varies from -1.8 to $+1.8$ db. Since the four transducers used to obtain data for the "compensated output" response curves of Figs. 15 through 18 were also used to obtain other data, they will, for reference purposes, be called Transducers 1, 2, 3, and 4. A disadvantage of this filter was that the distortion due to the mechanical resonance had not been reduced sufficiently. To obtain constant response between transducers, the filters must vary in characteristics from one to the other. A variable filter can be constructed, but this means

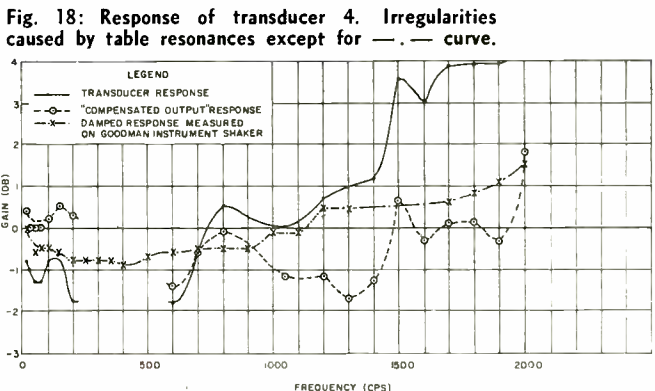

Fig. 18: Response of transducer 4. Irregularities caused by table resonances except for — — curve.

calibration with a particular transducer. These results indicated that this approach was not as favorable as it originally had appeared.

Distortion at the Source

Since filtering action did not accomplish the solution to distortion, an attempt was made to eliminate, or at least to lessen, the distortion at the source. The transducer housing (Fig. 19a) was filled with 1000 centistokes silicone fluid and sealed with an epoxy. (Fig. 19b.) A schematic representation would indicate distributed spring and damping action throughout the length of the crystal. It was anticipated that this damping and spring action caused by the fluid would broaden the first mode resonance of the bending crystal and shift this mechanical resonance to a slightly higher frequency. Results of the response are shown in Fig. 20. It was assumed that the mass effect would not override the spring effect and result in a decrease in the mechanical resonance frequency. Weight of the unit increased to 0.7 gm, while the size and shape remained unchanged. Results were improved, although they were not entirely satisfactory. In observing the output waveform, it was noted that the distortion was practically eliminated; however, the sensitivity decreased to 2 mv/g. At the lower frequency range, the output was attenuated considerably; below 250 CPS it was beyond accurate measurability.

Although it resulted in an extremely small output in the low frequency range, fluid damping was thus far the best approach to the distortion problem. The silicone fluid was replaced with neoprene blocks. This lumped the spring and damping action to the particular area adjacent to the blocks. As shown in Fig. 21a, two small pieces of neoprene material were placed at the free end of the crystal. The output during vibration was again reduced to an impractical extreme. These two insertions were then moved to approx. the center of the crystal as in Fig. 21b. Although the distortion caused by subharmonics of the mechanical resonance frequency was not completely eliminated, it was reduced to an acceptably low level. With respect to the frequency response curve, a variation of less than ± 2 db was obtained. Even though the addition of the damping material caused a decrease from the original output, which was in the neighborhood of 10 to 14 mv, the sensitivity of the final design remained above 4 mv/g exciting force at the normalizing frequency.

Comparison of results between the 2-g and 4-g level inputs indicated that the linearity in the output was well within the tolerable $\pm 10\%$ deviation. In many instances the linearity deviation was less than $\pm 2\%$ —all of the originally intended specs had been achieved.

Fig. 19: Before and after damping with silicone fluid.

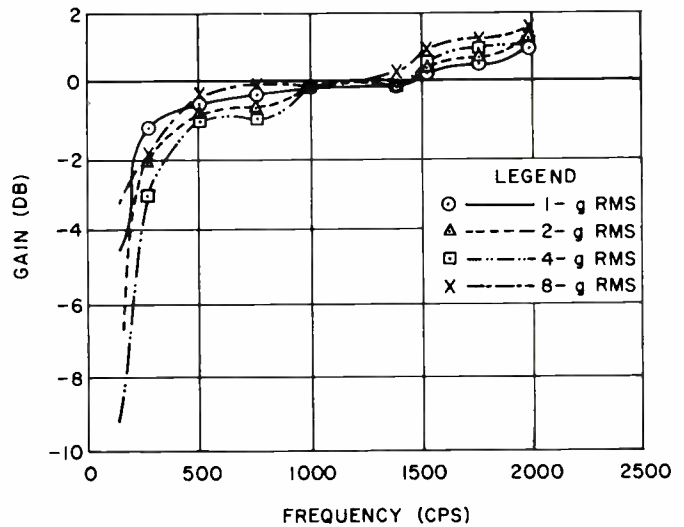
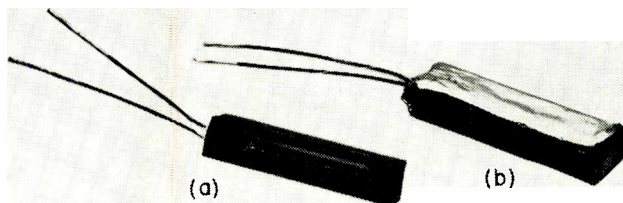

Fig. 20: Fluid damped response characteristics.

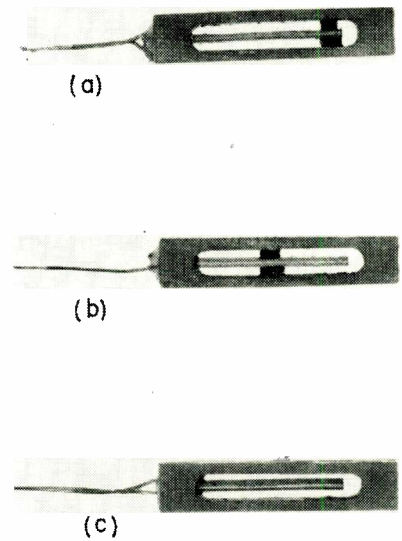

Fig. 21: (a) With Neoprene damping at free end. (b) With Neoprene damping in center; and (c) Without damping.

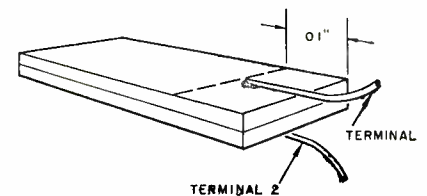
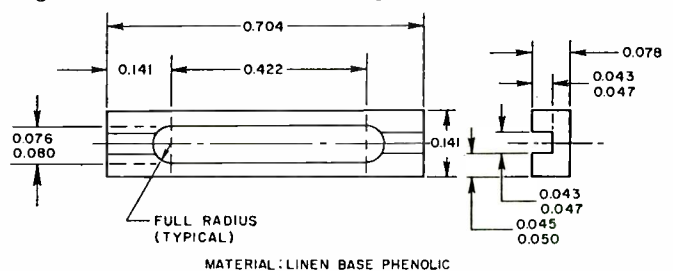

Fig. 22: Terminal leads soldered to crystal.

To substantiate the results from the latest design, data were obtained from three other transducers which had been previously fabricated for the "compensated output" test. Inserting neoprene blocks was all that was required to modify these units. Data from these three transducers were plotted on the same graphs as the data which had been previously obtained for these transducers. (See Figs. 15, 16, and 17.) This

Fig. 23: One-half of transducer housing.



Transducers (Continued)

allows a better comparison of the normal, the compensated output response, and the neoprene damped outputs.

The curves of Figs. 15 through 17, show that the frequency response variation remained within ± 1 db over the range used for testing on the exciter now being used. This was more of an improvement than had been anticipated. To confirm this design, and to obtain data in the frequency range for which the results obtained from the substituted exciter were not acceptable, one of the transducers was placed on a precision Goodman Instrument Shaker. To establish the acceptability of the input excitation, it was monitored with a secondary standard Endevco accelerometer. The data, entitled "Damped Response Measured on Goodman Instrument Shaker," are plotted in Fig. 17 along with data received from previous tests performed on the same transducer. As seen in the graph, the frequency response is more than satisfactory considering its initial purpose. When the Goodman shaker was used as the exciting source, observations of the transducer output waveform on an oscilloscope revealed only a very slight distortion. Also tested on this instrument table was the transducer which, before modification, had the greatest variation in the upper frequency response. When testing the normal response of this transducer before the insertions were added, a 6-db gain over the response of the normalizing frequency of 2000 CPS resulted. Even with this deviation, the neoprene insertions reduced the output to a +1.5-db gain at 2000 CPS, which is within the tolerable limits. The improvement in frequency response may be seen in Fig. 18.

It is felt, that varying the type of material of the insertion and shifting its location with respect to the active element would result in a low-cost, lightweight expendable transducer that could be used in many vibration monitoring applications where the above features, with a reasonable response, are desirable and where precision accuracy is not essential.

Applications

There are many applications where this unit may be used to advantage. For example, it was necessary for a particular operation to determine whether specific gyros were functioning properly. It appeared that this transducer offered the simplest method of detection. Lead zirconium was substituted for the barium titanate to cope with the existing high ambient temperature of the equipment. This device had the capability of differentiating between extremely low vibrations caused by the gyro and those generated by other mechanically operating equipment in the vicinity of the gyros. Thus, the versatility of the transducer seemed established.

Conclusions

The final design of the transducer meets requirements. It is extremely light in weight (approx. 0.35 gm) and can be quickly and easily secured in place with an adhesive cement, such as Eastman No. 910. Also, with only one exception, the units tested have a sensitivity greater than 4 mv/g, which may even be

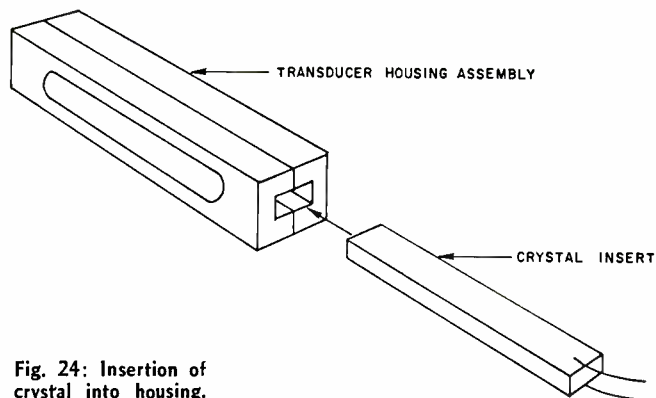

Fig. 24: Insertion of crystal into housing.

increased through experimentation. Linearity between g levels is within a 10% variation and, under uniform fabrication methods, should easily approach a tolerance of less than 2%. The size (0.156 x 0.141 x 0.704 inch) allows dynamic measurements previously prohibited by larger, commercial accelerometers. A repeatable frequency response remaining within ± 1.5 db has been achieved. Its total cost is low enough so that it is expendable; the barium titanate crystals may be purchased for approx. \$1.00 each, and the housing can be made by a punching process for even less. Though these transducers are fragile with respect to lead and crystal damage, sufficient precaution used during handling will reduce the breakage to a negligible amount.

Appendix

Fabrication

Barium titanate crystals of the type used in a Sonotone 2TS phonograph cartridge were used. A No. 28 magnet wire lead was soldered to each surface of a crystal within 0.1 in. from one end. (See Fig. 22.) Due precaution was exercised during soldering to prevent damage of the crystal from heat.

Each crystal housing was fabricated from two identical pieces, the dimensions of which are delineated in Fig. 23. These halves were joined and cemented with an epoxy (Fig. 24). Curing time was approx. 4 hr.

The crystal was then inserted in the end of the phenolic housing (Fig. 24), assuring that the end of the crystal containing the wire leads was flush with the housing. To center the crystal, it was necessary to use some type of removable support that would not damage the crystal. The crystal was then cemented in the housing with an epoxy. Precautions were taken to prevent the epoxy from extending beyond the housing support toward the free end of the crystal. Two pieces of neoprene 0.075 x 0.075 in. were cut, the thickness being slightly greater than the allowable space between the crystal and the housing. These pieces were then secured in place at approx. the center of the crystal, using an adhesive to prevent loss or movement.

References

1. Cady, Walter G., "Piezoelectricity: an Introduction to the Theory and Applications of Electromechanical Phenomena in Crystals." New York: McGraw-Hill Book Co., Inc., 1946.
2. Crawford, Alan E., "Ultrasonic Engineering," with Particular Reference to High Power Applications. London: Butterworth's Scientific Publications, 1955.
3. Boast, Warren, B., "Principles of Electric and Magnetic Fields." 2nd Ed. New York: Harper & Bros., 1956.

**NEW FROM
CINCH...**

BIFURCATED

Printed circuit

board edge connectors

to maintain positive contact!

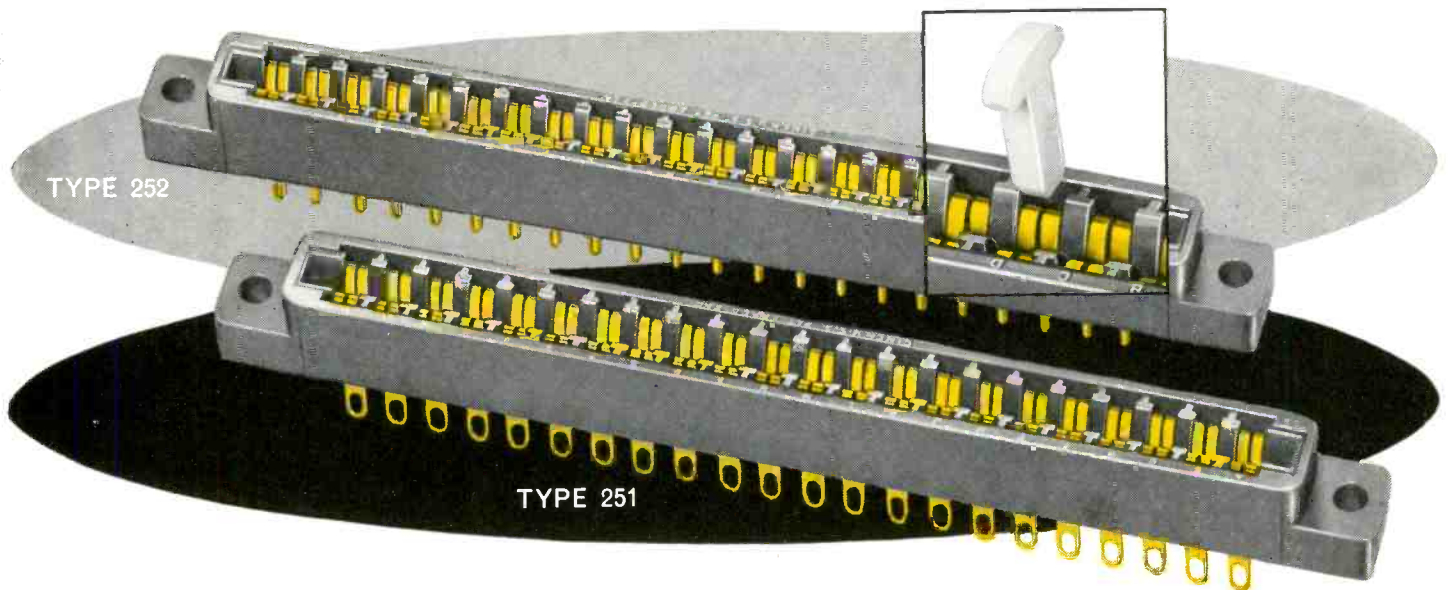

NOW AVAILABLE FOR IMMEDIATE DELIVERY! Bifurcated Contact Connectors with two flexing surfaces instead of one to provide positive contact! . . . accommodate irregularities in Printed Circuit Boards.

TWO TYPES—conventional wiring tail (type 251) or dip solder (for .051 dia. hole) (type 252) . . . with 6 to 25 contact positions (12-50 contacts).

INSULATION—glass filled diallyl phthalate type GDI 30 per MIL-M-19833.

POLARIZING KEYS—can be supplied loose, or inserted in any position designated.

FINISHES—phosphor bronze or beryllium copper00003 Min. Sel-rex. gold plated.

PART NUMBERS—customer part numbers imprinted when required.

MEETS MIL-C-2109A (ships) specs for printed wiring board connectors.

WRITE FOR FULL INFORMATION TODAY! Complete details and performance specifications on new Bifurcated Cinch Printed Circuit Board Edge Connectors are available for the asking. Write for full information now.



**Cinch
ELECTRONIC
COMPONENTS**

CINCH MANUFACTURING COMPANY

1026 South Homan Avenue • Chicago 24, Illinois
Division of United-Carr Fastener Corporation, Boston, Massachusetts

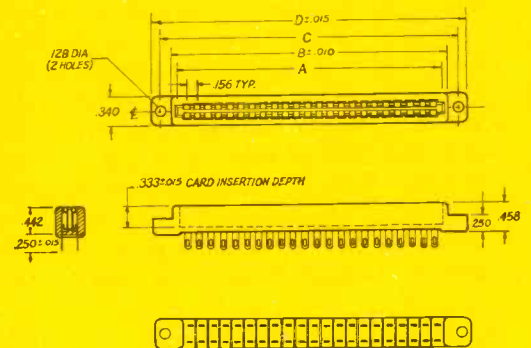

Contact* Positions	DIMENSIONS			
	A	B	C	D
6	1.098	1.239	1.531	1.785
7	1.254	1.395	1.687	1.941
8	1.411	1.552	1.844	2.098
9	1.567	1.708	2.000	2.254
10	1.723	1.864	2.156	2.410
11	1.879	2.020	2.312	2.566
12	2.036	2.177	2.469	2.723
13	2.192	2.333	2.625	2.879
14	2.348	2.489	2.781	3.035
15	2.504	2.645	2.937	3.191
16	2.661	2.802	3.094	3.348
17	2.817	2.958	3.250	3.504
18	2.973	3.114	3.406	3.660
19	3.129	3.270	3.562	3.816
20	3.286	3.427	3.719	3.973
21	3.442	3.583	3.875	4.129
22	3.598	3.739	4.031	4.285
23	3.754	3.895	4.187	4.441
24	3.911	4.052	4.344	4.598
25	4.067	4.208	4.500	4.754

*Number of contacts equals contact positions times two.

Centrally located plants at: Chicago, Illinois; Shelbyville, Indiana; City of Industry, California and St. Louis, Missouri

Circle 83 on Inquiry Card

This lab type instrument, in conjunction with a suitable digital counter, will measure pulse width, pulse repetition period, and double pulse interval.

Build a Simple Delay Line Clock

By **RONALD M. SONKIN**

Engineer
Electronic Reconnaissance Lab.
ITT Laboratories
500 Washington Ave.
Nutley 10, N. J.

THE delay line clock is a useful laboratory instrument for both jitter and absolute measurements.

The accuracy of the measurement will be to within Δ , where Δ = delay of the delay line.

The circuit shown in Fig. 1 operates reliably with $\Delta = 0.2 \mu\text{sec}$. With slight modification it can be made to operate with a Δ as low as $0.1 \mu\text{sec}$ (10 MC rate).

The clock may be stopped after some arbitrary number of counts by applying a stop pulse at point G. The stop clock pulse should have a minimum width of Δ , so that one pulse will be at the output of the delay line during the stop pulse interval.

The waveforms appearing at the various points of the circuit are shown in the timing diagram of Fig. 2. Operation of the circuit is as follows: A positive pulse fed to the input is inverted in T_1 . It is differentiated and the leading edge is coupled to the base of T_3 through diode D_1 . This causes T_3 to go into saturation. The pulse appearing at D is delayed by Δ and inverted by T_4 . The delayed pulse then drives T_5 toward cut-off. Output from T_5 is coupled back into T_3 by

diode D_2 . Thus a continuous circulation of pulses spaced $\Delta \mu\text{secs}$. apart appears at the output. On the trailing edge of the input pulse the voltage at B drops to zero. This clamps point F to zero volts through D_3 and does not allow any pulse to appear. Alternately, a stop clock pulse applied to point G will clamp point F to zero volts through diode D_4 and stop the clock.

The circuit parameters given in Fig. 1, are for $\Delta = 0.2 \mu\text{sec}$. and $R_o = 500 \Omega$.

In order to measure pulse repetition period it will be necessary to provide an input signal which corresponds to the separation between two successive pulses. This can be done by feeding the pulse train into a flip-flop that triggers on the first pulse and resets on the second pulse.

If the difference in time between two pulses is to be measured, diode D_3 should be removed from the circuit of Fig. 1. This allows the clock to free run after the first pulse. The second pulse is fed to the external stop pulse input. Thus the difference in time between the start and stop pulse is measured.

Fig. 1 (below): Complete delay line clock circuit is given.

Fig. 2 (right): Waveforms are for various points of circuit.

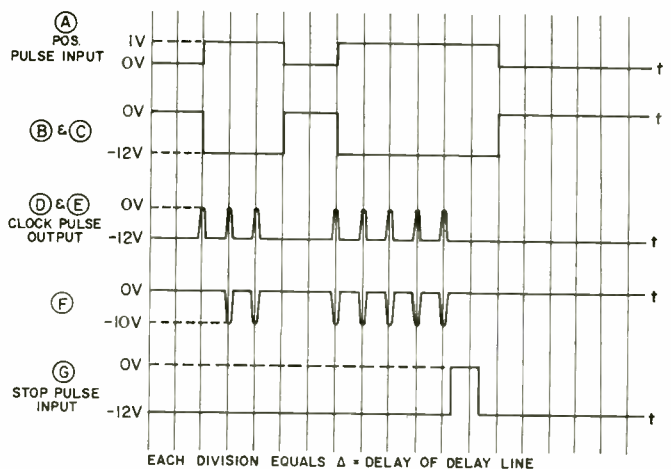
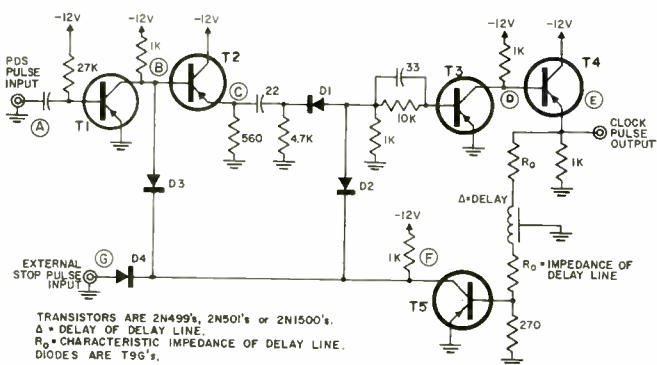

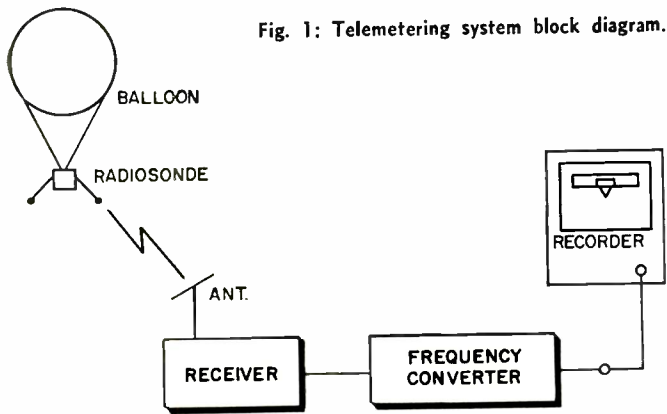

Fig. 1: Telemetry system block diagram.

Transistorized equipment, used by the Weather Bureau, records frequency of pulses from meteorological transmitter in free flight.

Radiosonde FM Receiver/Converter

By **ABRAHAM ZEDER**

*Telectro Industries Corp.
35-18 37th St.
Long Island City 1, N. Y.*

A TRANSISTORIZED F.M. radiosonde receiver and frequency converter for shipboard operation receives a 72.2 MC r-f signal from a radiosonde in free flight and converts this signal into a direct current output which is linearly proportional to the pulse frequency. Dc output is measured and recorded on a strip chart recorder.

The signal is pulsed off for a period of 150 to 300 μ sec. at a repetitive rate of 10 to 200 pulses/sec. Modulation of the radiosonde transmitter is used to telemeter measurements of temperature, relative humidity, and pressure of the air through which it passes. The transmitter is a single triode 72.2 MC, A M keyed oscillator, which produces an output that is both amplitude and frequency modulated. FM signal is used for telemetering to provide better signal-to-noise ratio in reception.

Data produced on the strip-chart are evaluated to determine atmospheric conditions at various altitudes as transmitted by the radiosonde. (See Fig. 1.)

The Receiver

The radiosonde transmitter dictates the receiver's tuning range and sensitivity. Since the transmitted frequency varies over a wide

range, the receiver is tunable from 62 to 82 MC.

High sensitivity was designed into the receiver. Transmitter output is approx. 200 mw. Receiver is sensitive to less than 2 μ v, from 62 to 82 MC for 30 db quitting.

The Frequency Converter

The frequency converter receives short pulses from the discriminator output, with repetition rates from 10 to 200 pulses/sec and converts them to a dc output proportional to the repetition rate.

Operational Theory

Tuner section consists of 3 high-frequency drift transistors, an r-f amplifier, mixer, and oscillator; all components are connected in the grounded base mode. (Fig. 2.) This provides 24 db gain and is inherently more stable than the common-emitter connection.¹

Four stages of single-tuned i-f stages follow the tuner section. Here drift transistors are again used, except at 10.7 MC they are operated as grounded emitter amplifiers. The i-f strip has a gain of 60 db.

Limiting was derived from biased junction diodes in the collectors of the 3rd and 4th i-f amplifiers.

A Forster-Seely discriminator is used for the demodulator because of the low frequency and linearity requirements.

An emitter-follower-buffer stage was added between the discriminator, the audio amplifier, and frequency converter stages; this prevents the discriminator from being loaded to a point where operation is impaired.

The frequency converter is actually a frequency meter which converts the pulse output from the discriminator into a dc voltage directly proportional to the frequency of the pulses.

Pulse output from the discriminator is amplified and limited. A Schmidt trigger is used to further amplify and square the pulses. Output is then differentiated and applied to a bistable multivibrator which through a phase inverter and push-pull amplifier drives a "Magmeter." The dc output is linearly proportional to the pulsed output of the radiosonde and drives a bal-

(Continued on page 209)

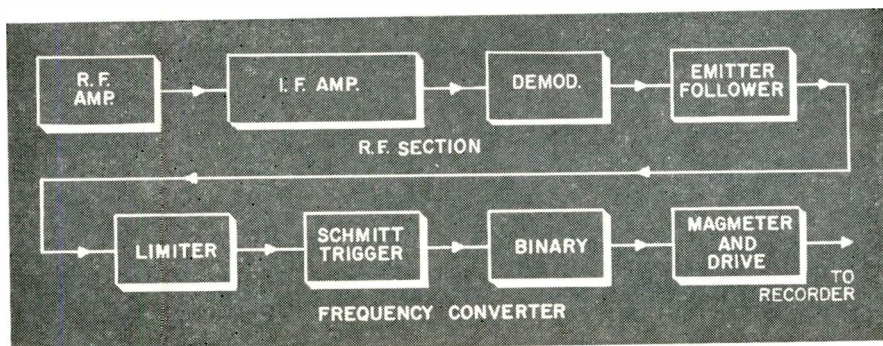
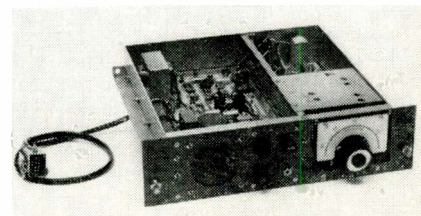

Fig. 2: Radiosonde receptor block diagram.

Fig. 3: Converter and receiver are on separate plug-in chassis.



Liquid-Level Switch

A new folder describes a unitized liquid-level switch which combines an ultrasonic probe and a transistorized control into an integral unit. In addition to specs, the folder also relates how the liquid-level sensor, either as an integral or separate unit, is capable of monitoring a large number of liquids, including cryogenic liquids, chemicals and petroleum products. Acoustica Associates, Inc., Gauge and Control Marketing Dept., 10400 Aviation Blvd., Los Angeles 45, Calif.

Circle 187 on Inquiry Card

Silicon Rectifier Stacks

Technical data bulletin, No. 6.315, contains information for design engineers and users on the specification and application of silicon rectifier stack assemblies. It includes specs, dimensions and typical performance curves on stacks incorporating Fansteel Type 6B (20 a) or Type 4B (35 a) silicon rectifiers. Formulas for calculating stack input voltages are given. Fansteel Metallurgical Corp., Rectifier-Capacitor Div., No. Chicago, Ill.

Circle 188 on Inquiry Card

Zener Protection Circuits

A 4-page application note, "Zener Protection Circuits for Aircraft Voltage Surges," from Motorola Semiconductor Products Div., 500 E. McDowell Rd., Phoenix, Ariz. The note includes circuit schematics, performance curves, and a nomograph showing quantity of zeners needed. There are a total of 8 illustrations.

Circle 189 on Inquiry Card

Panel Meters

New 24-page tech catalog on their line of electrical indicating panel instruments from Electronic Sales Div., DeJur-Amsco Corp., 45-01 Northern Blvd., Long Island City 1, N. Y. It includes specs, outline drawings, and general information covering a wide range of miniature and full size units from 1/2-in dia. to 4 1/2 in. dia.

Circle 190 on Inquiry Card

Gyros

Technical information for the engineer from Kearfott Div., General Precision, Inc., Little Falls, N. J. The 44-page booklet contains: Theory of the gyroscope; information on rate gyros, rate integrating gyros, free gyros, vertical gyros, directional gyros; drift; drift errors; stable platforms; precision accelerometers, and reference data.

Circle 191 on Inquiry Card

Push Button Lites

New 2-page Bulletin 69 describes the "Tec-Lite" MBL Series combination miniature indicator light and push button switch for computers, data processing, industrial control or signal systems. Shown are dimensional diagrams and optional electrical connection arrangements for Type A (Normally open) and Type B (normally closed) models. Specs are listed for 8 different incandescent and 3 neon type lamps available in the MBL Series. Transistor Electronics Corp., 3357 Republic Ave., Minneapolis 26, Minn.

Circle 192 on Inquiry Card

Planar Triodes

Application of Ceramic Planar Triodes—Bulletin PT-46, 32 pages—provides information on application of GL-6442 and GL-6771 disk-seal triodes. Applications include amplifiers, oscillators and multipliers. Examples of typical circuits are included as well as complete tech. data on the 2 tubes and a discussion of the principal considerations of high-frequency cavity design. General Electric Power Tube Dept., Schenectady 5, N. Y.

Circle 193 on Inquiry Card

Triode Oscillator

Single-page data sheet from John Gombos Co., Inc., Webro Rd., Clifton, N. J. describes their model 101 C, "C" Band Triode Oscillator. It is the general-purpose member of a family of oscillators designed around the GL-5139 ceramic triode. It has applications for local oscillators, CW signal sources, and drivers for crystal harmonic generators.

Circle 194 on Inquiry Card

Static Power Conversion

A 16-page static power conversion guide explains the new field of controlled electrical power. The booklet outlines the advantages of static power equipment and provides useful comparisons between static and rotating electrical devices. Hamilton Standard Div., United Aircraft Corp., Windsor Locks, Conn.

Circle 195 on Inquiry Card

Portable Oscilloscopes

A 16-page booklet gives a detailed presentation of the 7 available Tektronix oscilloscopes with 3 in. cathode-ray tubes, including the rack-mount models. The booklet contains complete specs, performance characteristics, illustrations, for all 7 instruments. Tektronix, Inc., P.O. Box 500, Beaverton, Ore.

Circle 196 on Inquiry Card

Servo Motor

New 20-page servo motor short-form catalog includes spec. data on line of 60 and 400 CPS servo units. Inertial damped servo motors and servo motor-tachometers are included. For transistorized circuitry as well as high temp. operation, the units are also designed to withstand conditions of shock, vibration, humidity and altitude. Mechanically, units range from size 5 upwards. IMC Magnetics Corp., Eastern Div., 570 Main St., Westbury, L. I., N. Y.

Circle 197 on Inquiry Card

Rigid Coax Lines

A 20-page catalog covers rigid coaxial transmission lines and associated equipment. It offers a selection of 50 ohm line and fittings in the size range from 7/8 to 9 in. A new 3 1/8 in. coaxial transfer switch is introduced in Catalog R. Andrew Corp., P.O. Box 807, Chicago 42, Ill.

Circle 198 on Inquiry Card

Relays

Engineering Bulletin No. 1010 describes new plastic Model DOS type relays. These general purpose relays have contacts and terminals mounted in molded phenolic parts. Physical and mechanical data is provided. Also information on the complete line of Model DOS relays. Ohmite Mfg. Co., 3630 Howard St., Skokie, Ill.

Circle 199 on Inquiry Card

Photometry

The terms, symbols, and units used in photometry are defined in this Application Note, AN-187, and their relationship to corresponding radiometric terms is given. In addition, the Note presents methods for the calculation of tube-face illumination for camera tubes, and screen luminance for cathode-ray tubes. Radio Corp. of America Commercial Engineering, Electron Tube Div., Harrison, N. J.

Circle 200 on Inquiry Card

Potentiometers

New 4-page brochure summarizes key information on Company's complete line of Trimpot[®], Trimit[®] and Twinpot[®] leadscrew and wormgear actuated potentiometers. It contains basic specs such as terminal types, resistance ranges, end settings, tolerances, power rating, operating temp., size and price on each of 13 models. It also contains cutaway drawings of the basic types. Bourns, Inc., 6135 Magnolia Ave., Riverside, Calif.

Circle 201 on Inquiry Card



Popular, small Model VT2 (with overvoltage). Volts output: 0-120/132; amps output: 1.5... Model VT2N (without overvoltage). Volts output: 0-120; amps output: 1.8. This model delivers more current than existing transformers of comparable size and price.

Models VT4 and VT4N Model VT4 (with overvoltage). Volts output: 0-120/140; amps output 3.5... Model VT4N (without overvoltage). Volts output: 0-120; amps output: 4.75.

OHMITE

VARIABLE TRANSFORMERS

Complete Line Now Available from Stock



Models VT8 and VT8N offer the heavy capacity demanded for general laboratory and industrial applications. Model VT8 (with overvoltage). Volts output: 0-120/140; amps output: 7.5... Model VT8N (without overvoltage). Volts output: 0-120; amps output 10.0. Units available for 240-volt input also.

Now you can get *fast delivery from stock* on 38 different models of Ohmite variable transformers. This newly expanded selection covers a high percentage of industrial needs. In it you will find single and three-phase units, two and three-in-tandem assemblies (not shown above), plus a variety of other cased and uncased models.

Ohmite "v.t." variable transformers combine fresh thinking in design with traditional Ohmite quality. For example,

positive current transfer is achieved with direct brush to slip-ring, pig-tailed connection. Adjustable shafts on sizes VT4 and VT8 extend either to the brush or the base side. These two models also are *interchangeable* with competitive makes of comparable ratings. The "N" types in all three models provide additional current without overvoltage. The next time you need variable transformers, select from the line with advanced design—Ohmite.

NEW 36-volt, high-current units for transistor circuit applications... write for Bulletin 151

- RHEOSTATS RESISTORS RELAYS
- TAP SWITCHES TANTALUM CAPACITORS DIODES
- VARIABLE TRANSFORMERS R. F. CHOKES



OHMITE MANUFACTURING COMPANY
3662 Howard Street, Skokie, Illinois

New Tech Data

for Engineers

Waveguide

A 116-page Waveguide Components and Test Equipment Catalog describes over 750 waveguide devices and test equipment items. Applications notes, outline drawings, detailed electrical and mechanical specs, and photographs are included. The components are cross-referenced and indexed both by function and by frequency band of operation. Microwave Associates, Inc., South Ave., Burlington, Mass.

Circle 161 on Inquiry Card

Silicone

Super-thin field silicone rubber cures without heat. It simplifies and improves potting and encapsulating of electronic units. Silastic RTV 521 pours and flows like coffee cream, completely filling narrow channels, fine cracks, and hard-to-reach sections of complex parts. It begins to cure or vulcanize soon after addition of catalyst but remains in a workable consistency for a few hrs. After 24 hrs. at room temp., it becomes a moisture-proof, weather-proof silicone rubber with excellent electrical properties. Fully cured, it remains rubbery from -70 to 500°F and withstands temps. to 600°F for short times. Information available from Dow Corning Corp., Midland, Mich.

Circle 162 on Inquiry Card

Electron Tube Shields

Heat-dissipating electron tube shield catalog, covers heat-dissipating tube shield components for sub-miniature size electron tubes. The 22-page bound catalog, 2-colors, contains design, application, installation and assembly data pertinent to increasing electron tube reliability and extending tube life through effective cooling. Dimensional drawings, photographs, charts and performance graphs are included. Test results, military specs, references to directives and handbook data on heat-dissipating electron tube shields are also included. IERC Div., International Electronic Research Corp., 135 W. Magnolia Blvd., Burbank, Calif.

Circle 163 on Inquiry Card

Connector Line

A 2-page product information bulletin describes a new line of multiple circuit connectors, called AMPEEZ, which feature high amperage ratings plus low insertion and extraction forces. Photographs and a general description of the new connectors are given, and potential applications in the appliance, electrical, electronic and power equipment fields are discussed. AMP Inc., Harrisburg, Pa.

Circle 164 on Inquiry Card

Optical Masers

Booklet describes theory and design of the solid state optical maser. The 8-page booklet is a reprint of an article by A. L. Schawlow of the Laboratories' Research Dept., which appeared originally in the Bell Laboratories Record. Bell Telephone Laboratories, Murray Hill, N. J.

Circle 165 on Inquiry Card

Die Stamped Circuits

"Designing with Die Stamped Circuits," Bulletin No. D1, compares features of die stamped circuits, a relatively new development in printed circuitry, with those made by etching copper-clad laminated plastics. The die stamped circuits are made by die-cutting the conductor pattern from copper foil coated on one side with a thermoresponsive adhesive and simultaneously bonding it, under heat and pressure, to the base material. The second section gives hints for the design of die stamped circuits, including layout fabrication, artwork, nomenclature and current carrying capacity. Also included are standard tolerances for fabricating die stamped circuits, including those for smooth saw, hole diameters, slots and notches, hole location, hole-to-circuit pattern, front-to-back pattern, circuit pattern to outside dimension, overall dimension, holes to outside dimension, line width and spacing, plating and board warp. The final section gives definitions for the most common terms used in printed circuit design. Dytronics, Inc., 115 Main St., Rochester, Mich.

Circle 166 on Inquiry Card

High Temp. Hook-up Wire

Information on a new mica and glass lead wire capable of reliable operation up to 1000°F is available from American Super-Temperature Wires, Inc., West Canal St., Winoski, Vt. Known as Tetralene Type MGT, the wire has been subjected to extensive heat-cycle tests without destruction to the insulation. It has also been determined that the wire will maintain a min. dielectric strength of 1000 v. It has been successfully spark-tested at 2000 v. Insulation resistance is maintained at above 10,000 megohms.

Circle 167 on Inquiry Card

Input Transformer

New data sheet describes, illustrates and gives circuit diagrams of Series 7100 electrostatically and magnetically shielded instrument transformers. They are for chopper, ac transducer and differential input. James Electronics, Inc., 4050 N. Rockwell St., Chicago 18, Ill.

Circle 168 on Inquiry Card

Silicon Diodes

Literature containing tech. data and information, list the firm's line of industrial, commercial electronic and military medium power silicon diodes. The new product types are listed as: medium power diffused junction silicon general purpose diodes, medium power silicon double anode (twin zener) diodes, and medium power diffused junction silicon zener diodes. Performance characteristics, ordering instructions, and general tech. data included. Charts and curves illustrate operational characteristics. Controls Co. of America, Electron Div., Tempe, Ariz.

Circle 169 on Inquiry Card

Null Indicators

Two-color catalog sheet, NI, offers tech. data on a line of small-size, fully transistorized, phase-sensitive null indicators. Units may be combined with any standard RatioTran[®] to form an ac ratio bridge. Three ranges of sensitivity are provided: 10 μ v; 100 μ v; and 1000 μ v. A max. sensitivity of 10 μ v allows excellent resolution for bridge circuit operation. A zero-center meter gives the operator sense as to being above or below null. Phase-sensitive detector provides quadrature rejection. Described are two types: Model NI-2 (battery operated) and Model NI-3 (3½ in. high rack mounted version). Also, a block diagram and a complete circuitry description. Gertsch Products, Inc., 3211 So. La Cienega Blvd., Los Angeles 16, Calif.

Circle 170 on Inquiry Card

Metalizing Ceramic Parts

Engineering Bulletin on the metalizing of ceramic parts describes permanent bonding techniques. It describes preliminary design and engineering considerations and covers properties and applications of Centralab steatite and high alumina ceramics suitable for low and high temp. metal to ceramic seals. (Form CB-1030) Centralab, The Electronics Div., Globe-Union, Inc., 900 East Keefe Ave., Milwaukee 1, Wis.

Circle 171 on Inquiry Card

Ultrasonic Cleaners

New 2-color sheet illustrates and describes the Ultra-Clean 320 Series of ultrasonic cleaners. The sheet contains illustrations and cutaway diagrams of the 320 (with one 1¼ qt. transducerized tank and one 1¼ qt. rinse tank), the 320D (with two 1¼ qt. transducerized tanks with selector switch) and the 320L (with one 3¾ qt. transducerized tank). Complete specs included. L & R Mfg. Co., 577 Elm St., Kearny, N. J.

Circle 172 on Inquiry Card

New Tech Data

for Engineers

Size 8-11 Servomotors

Catalog shows new models and updated specs on Size 8 and 11 servomotors. The 24-page, 2-color catalog shows revised model numbers, complete electrical and mechanical specs, outline drawings and Torque-Speed curves. Both the Size 8 and 11 lines include, as standard units: servomotors, velocity-damp servomotors, inertia-damp servomotors and servomotor-generators; with optional voltage requirements and mechanical characteristics. Of special interest is a 2-page technical discussion of damping theory. This compares and evaluates the various means to achieve damping, including rate-feedback and velocity-damping. Development of pertinent transfer function equations is also shown. Helipot Div., Beckman Instrument, Inc., 2500 Fullerton Rd., Fullerton, Calif.

Circle 173 on Inquiry Card

Amplifiers

Amplifying and equalizing equipment for voice frequency signals is described in a series of 3 bulletins. Units are the 524 V.F. Amplifier Unit for raising voice frequency input signals; Type 85 Amplifier-Equalizer Unit for use in transmission systems where amplification is necessary to compensate for line characteristic variations; and the 524A Vogad for use at the output of a receiver to maintain a constant signal level with varying levels of signal input. Photos, diagrams, and specs included. Westrex Communications Equipment Dept., 540 W. 58th St., New York 19, N. Y.

Circle 174 on Inquiry Card

Fiberglass Cases

Catalog of molded fiberglass cases includes buying information. It includes drawings, photographs and specs for hand-portable, lightweight cases to house small equipment. Catalog features cases in 22 standard sizes with custom designed interiors to assure max. protection for delicate optical, electrical and electronic equipment in accordance with MIL-T-945A and MIL-STD-108C. Dept. LR-1, Skydyne, Inc., River Rd., Port Jervis, N. Y.

Circle 175 on Inquiry Card

Silicon Rectifiers

An 8-page illustrated booklet (SG-1351) on silicon rectifiers includes a comprehensive selection guide. Listing more than 400 different rectifiers, it also contains: complete circuit constant charts for power supply design; a special section on high voltage silicon rectifiers; rectifier circuit design application notes; and rectifier cell outline drawings. Transistron Electronic Corp., Wakefield, Mass.

Circle 176 on Inquiry Card

Uni-Tunnel Diode

Copies of the Sept.-Oct. issue of the Hoffman SPAN (Semiconductor Product Application News) contain illustrated articles on "Voltage Regulator Diode Surge Ratings" and "The Silicon Uni-Tunnel Diode." Also a story on "Solar Cells for Voice Transmission." Hoffman Electronics Corp., Public Relations Dept., 3761 So. Hill St., Los Angeles, Calif.

Circle 177 on Inquiry Card

Electrical Tape

"Reference Data for Design Engineers," a property chart covers all "Scotch" brand electrical tapes. It is available from Dept. WO-482, Minnesota Mining and Mfg. Co., (3M), 900 Bush Ave., St. Paul 6, Minn. Designed for quick reference, the chart lists typical properties, standard slitting tolerances, standard lengths and military specs of 31 tapes, ranging from paper to silicone rubber. A list included in the 4-page publication describes 9 additional sales brochures and catalogs available.

Circle 178 on Inquiry Card

Environmental Testing

Bulletin C-11-2 describes the Company's line of all-Lucite salt spray chambers for environmental testing. The 2-page data sheet gives working dimensions, specs, and price information on the 4 models that comprise the test chamber series. The chambers meet corrosion test requirements of MIL-E-5272C; MIL-S-19500B, PARA 40.9, and other military and commercial specs. Associated Testing Laboratories, Inc., Wayne, N. J.

Circle 179 on Inquiry Card

Military Components

Listing of Company's military components includes all types of Mil. Spec. potentiometers and resistors, and their respective military designations. Clarostat Mfg. Co., Inc., Dover, N. H.

Circle 180 on Inquiry Card

Selector Switches

New 4-page, 2-color catalog illustrates and gives tech. details on Series 212, 1- $\frac{1}{8}$ in. dia. 12-position 30° indexed rotary switches for low power r-f, VHF and UHF applications. Included are photos, dimensional drawings, electrical specs, mechanical characteristics, features and constructions and description of new balanced lever arm and star wheel detent assembly. CTS Corp., Elkhart, Ind.

Circle 181 on Inquiry Card

Industrial Phototubes

Phototubes in Industry, (PA-220), a new bulletin in the "Tech Tips" series describes high-vacuum as well as gas phototubes, photomultiplier tubes, photocells and photoresistive cells. Typical applications are shown for photoresistive cells combined with transistors. The effects of temp., excessive illumination and other environmental conditions are described. CBS Electronics, Information Services, 100 Endicott St., Danvers, Mass.

Circle 182 on Inquiry Card

Decade Amplifier

Information on an ac and dc coupled decade amplifier available from Quan-Tech Laboratories, Inc., 60 Parsippany Blvd., Boonton, N. J. The amplifier, Model 201-B, is a compact, stable, wide-range amplifier with an accurately controlled voltage gain of 10. Frequency response is from dc to several MC. It is for low-noise level amplification with high input and low output impedance.

Circle 183 on Inquiry Card

Pushbutton Switches

Two-page data sheet, No. 182, from Micro Switch, Freeport, Ill., a division of Minneapolis-Honeywell Regulator Co., covers, in detail, the 302PBI-T Series miniaturized lighted pushbutton switches. These switches offer double - pole, double - throw switching, long lamp life and 2-color indication in a unit of less than 1 in.³ Fifteen different display screen color combinations are available. Sheet includes construction, electrical ratings, dimensions, drawings.

Circle 184 on Inquiry Card

Readouts

Readout Fact Finder, 16-pages shows detailed comparison of the major types of in-line readouts, including electroluminescent, projected image, spherulic optic, NIXIE[®] tube, edge lighted, and electro-mechanical displays. All factors important in the selection of a display device are compared, i.e., readability, life, size, weight, drive requirements, cost, power, etc. Burroughs Corp., Electronic Tube Div., Dept. LR-5, P.O. Box 1226, Plainfield, N. J.

Circle 185 on Inquiry Card

Magnetic Shielding

Data sheet 154 explains how Netic Co-Netic magnetic shielding prevents distortion of relatively low velocity electron beam systems in tubes such as the Tonotron. Magnetic Shield Div., Perfection Mica Co., 1322 N. Elston Ave., Chicago 22, Ill.

Circle 186 on Inquiry Card

New Tech Data

for Engineers

Solder Alloy

Details on Alpha #38, a self-annealing, tin-base alloy for soldering wave guide assemblies from Alpha Metals, Inc., 56 Water St., Jersey City 4, N. J. Solder's high creep strength and good wetting facilities the soldering of flanges to wave guide barrels. It eliminates distortion caused by high temperatures and oxide films produced by brazing fluxes. It is applied at lower temperatures than silver solders; its melting range is 428 to 435°F.

Circle 285 on Inquiry Card

Rectangular Waveguide

Simplified chart for selection of appropriate flexible rectangular waveguides. Designed to assist in selecting flexible rectangular waveguides for specific applications, the chart incorporates such details as frequency, construction, materials, dimensions, bend radii, jacket and pressure requirements. Arrangement of these details enables selection of the proper device for individual requirements with a minimum of effort. (Chart No. TL-605). Technicraft Div., Electronic Specialty Co., 116 Waterbury Rd., Thomaston, Conn.

Circle 286 on Inquiry Card

Optics

"Optics in Gaging and Tooling—Today and Tomorrow" condenses into 10 min. reading time many of the essentials of optics application; optical engineering tools; interferometry; principles and applications of optical instrumentation. The concluding "look into the future" envisages the 0.01 sec. and the 10 millionth of an in. as possible accomplishments for an increased use of optics to check processes, as well as to control and test machines. Engis Equipment Co., Div. of Engineering & Scientific Instrumentation, 431 S. Dearborn St., Chicago 5, Ill.

Circle 287 on Inquiry Card

Recording Systems

Applications for digital tape recording techniques are described in a 20-page brochure from Minneapolis-Honeywell Regulator Co., 10721 Hanna St., Beltsville, Md. Among applications described: communications; media conversion; acquisition and reduction and high and low speed sampling. Functional and block diagrams included.

Circle 288 on Inquiry Card

Power Resistors

High power resistors having low inductance at high frequencies are described in a new engineering data sheet (CE-204) from Corning Electronic Components, Bradford, Penna. The H-type resistors are designed for circuit loading, damping and terminating, and are especially useful for dummy antennas. Power ratings range from 5 to 140a at 40°C. Ratings may be increased 12% if resistors are mounted vertically. If cooled with forced air, ratings may be increased up to 4 times. Min. resistances range from 10 to 30 ohms—max. from 25 to 70 ohms (conductor film continuous) and from 70K ohms to one megohm (film spiraled.) Temp coefficient is less than ± 500 ppm°C between -55°C and 235°C.

Circle 289 on Inquiry Card

Potentiometers

Brochure on precision potentiometers contains 6 product data sheets describing series of wire wound multi and single-turn potentiometers. Complete application information is given including applicable MIL specs and environmental data. Resistance values for multi-turn units cover range from 5 to 200,000 ohms with standard linearity tolerances to 0.3% for single-turn units, resistance values from 5 to 150,000 ohms with standard linearity tolerances to 0.2%. Lockheed Electronics Co., 6201 E. Randolph St., Los Angeles 22, Calif.

Circle 290 on Inquiry Card

Chilton's M-A-P points the way to DYNAMIC MARKETING in the decisive sixties

Alert marketing might have saved the 300 or so companies that went out of business this week.

A worth-while product—made right, and offered at a fair price—is not enough to assure success.

Something else is needed. A sure hand that guides your product from maker to user . . . through the most efficient channels.

There is no single answer . . . no sweeping generality. Marketing becomes scientific only when you yourself apply the necessary forces to your

product, your company and your market.

Chilton's Marketing Assistance Program (M-A-P) is almost certain to be of help to you. The very facts, figures and insight into your market that you need may cost you nothing. And they may be readily available—if not, M-A-P can help you obtain them fast and at reasonable cost.

Detailed information on each of the markets covered by Chilton's 19 outstanding business magazines is outlined in this new booklet. Write for a copy of "A Guide to Chilton's M-A-P."

Electronic Industries • Department Store Economist • The Iron Age • Hardware Age • The Spectator • Motor Age • Automotive Industries • Boot and Shoe Recorder • Commercial Car Journal • Distribution Age • Butane-Propane News • Marine Products • Aircraft & Missiles • Hardware World • Optical Journal and Review of Optometry • Jewelers' Circular-Keystone • Food Engineering • Gas • Product Design & Development • Chilton Book Division • Chilton Research Services

Chilton
COMPANY

Chestnut and 56th Streets • Philadelphia 39, Pa.

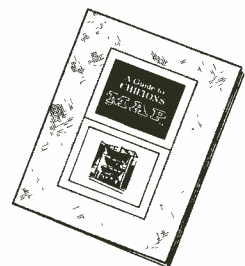



BMEWS ... *eyes of the free world*

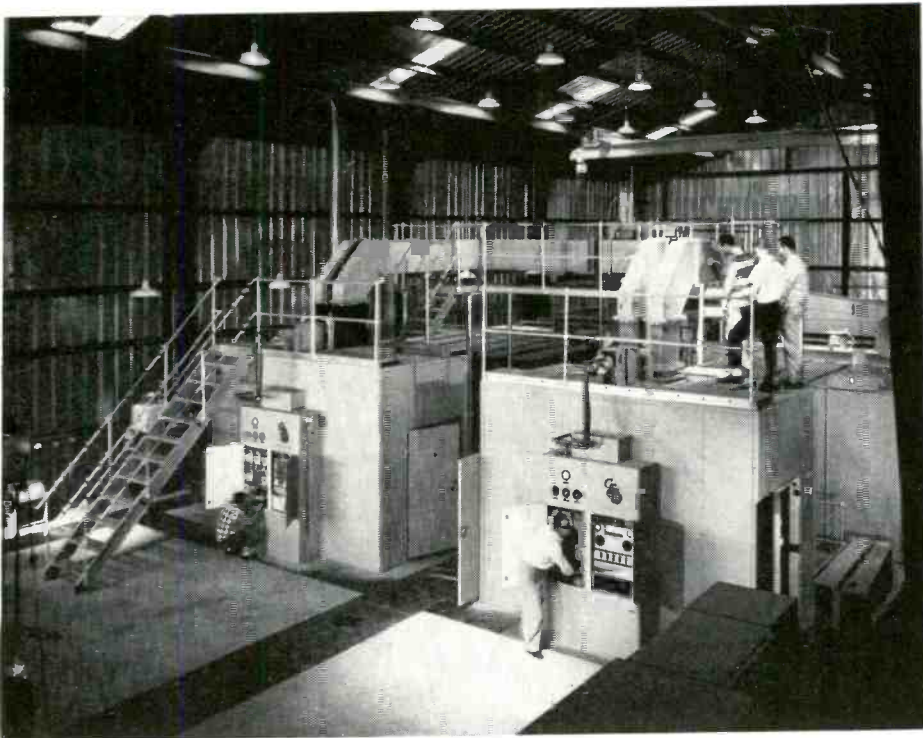

BMEWS ... the Ballistic Missile Early Warning System is the free world's first warning of enemy ICBM attack.

Powerful radars with an accurate range of thousands of miles can detect incoming ICBMs minutes after launching. The transmitters for this defense system are being built by Continental Electronics ... specialists in super power transmitting equipment.

Provided under sub-contract to General Electric and R.C.A., these transmitters from Continental Electronics are another contribution to our country's defense.

Continental Electronics Co

MANUFACTURING COMPANY

4212 South Buckner Blvd. • Dallas 27, Texas • EVergreen 1-1135 •  SUBSIDIARY OF LING-TEMCO ELECTRONICS, INC.

Circle 85 on Inquiry Card



DESIGNERS AND BUILDERS OF THE WORLD'S MOST POWERFUL RADIO TRANSMITTERS
ENGINEERS ... FOR STIMULATING WORK ON THE ELECTRONIC FRONTIERS OF TOMORROW WITH A DYNAMIC, CREATIVE ORGANIZATION, ADDRESS RESUME TO CHIEF ENGINEER.

TRAVELING WAVE TUBE

Tube is guaranteed for minimum of 6,000 hrs. It operates as a broad band amplifier in the 4400 to 5000 MC range. The 7537 is well suited for unattended microwave stations. Mount and tube are so designed that

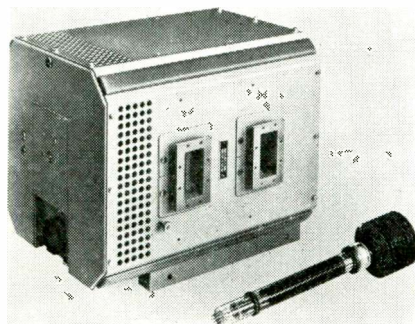

circuits remain matched when a new tube is inserted in the mount. It can deliver a saturated power output of 6 w. Gain at 5000 MC with the output power at 100 mw, is better than 34 db. With the output power at 2.5 w., the gain is better than 32 db. Noise figure is less than 30 db. Electron beam is focused by a permanent magnet. Tube is convection cooled. Amperex Electronic Corp., 230 Duffy Ave., Hicksville, L. I., N. Y.

Circle 214 on Inquiry Card

MODULAR TIMER

These timers may be used either as a self-contained solid state time delay, or to operate a separate magnetic relay. The size of the 406 Microminiature Timing Modules is compatible with the dimensions of magnetic relays of the microminiature type. Thickness varies from 1/2 in. up. All units have built-in protection against reverse polarity. Timings of 0.1 to 60 sec. are factory set; the operating voltage is 24 to 30

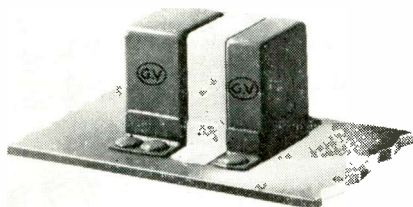

vdc; operating ambient -55°C to +100°C; shock 50g, 1lms; timing tolerance over the voltage and ambient range is within ±10%. G-V Controls Inc., Okner Pkwy, Livingston, N. J.

Circle 215 on Inquiry Card

TRANSISTOR TRANSFORMERS

New transistor audio transformers available for immediate delivery. TA-53, a miniature interstage transformer has a primary impedance of 5 KΩ CT and a secondary impedance of 45KΩ. TA 54, also an interstage

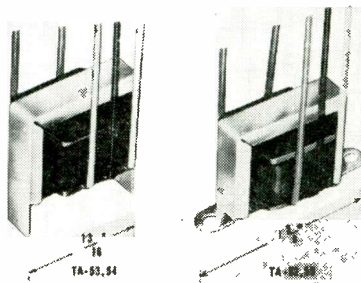

unit, has a pri. impedance of 20KΩ and a sec. impedance of 800Ω CT. Both units are rated at 0.15 w. and measure 13/16 x 5/8 x 11/16 in. TA-52, an interstage transformer, has pri. and sec. impedances of 500Ω CT, and TA-55, an input transformer with a pri. impedance of 500KΩ and a sec. impedance of 200Ω CT, are miniature units rated at 0.3 w. and measure 1 1/8 x 13/16 x 3/4 in. Chicago Standard Transformer Corp., 3501 W. Addison St., Chicago 18, Ill.

Circle 216 on Inquiry Card

SNAP-ACTION SWITCH

Switch Series EI3-00H features new low operating force hinged-lever actuator. Case-pivoted actuator arm is available with roller, straight lever with length and form variations for cam, roller or straight line actuation. Low cost basic switch design has standard mounting holes. Terminals accept standard quick connect or solder wiring connections. Switch is supplied in N.O., N.C. in SPST or SPDT models. Basic switch is also

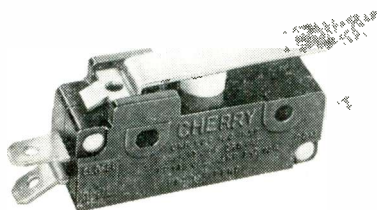

available with pushbutton, spring leaf, and standard button actuators. Ratings: 15 a., 125/250 vac. 3/4 hp vac. 1 1/4 hp 250 vac. Cherry Electrical Products Corp., West Deerfield Rd., Highland Park, Ill.

Circle 217 on Inquiry Card

SILICONE POTTING

A clear silicone potting and embedding compound provides mechanical and dielectric protection for components and assemblies. Called LTV-602 (low temp. vulcanizing), it cures at 70° to 80°C to a flexible,

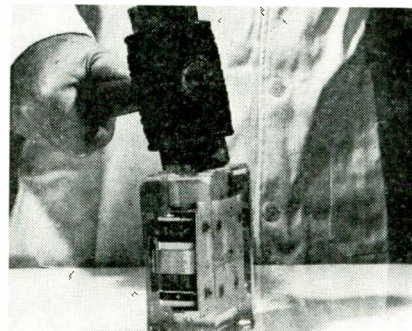

resilient solid. Material provides good protection against shock, vibration, moisture, ozone and corona and other environmental hazards. Components imbedded in the material can be repaired or replaced. New material can be poured into the cutout section, and cures without leaving evidence of repair. Material meets the thermal shock requirements of MIL-STD-202A. General Electric Co., Silicone Products Dept., Waterford, N. Y.

Circle 218 on Inquiry Card

PRECISE ANGLE INDICATOR

The CO2721011 Precise Angle Indicator features an accuracy of ±6 minutes. The unit also features good sensitivity, modular application, direct automatic readout, compact construction, ease of maintenance and low cost. The Indicator is available with a single sensor, auxiliary dual-input sensor, or an auxiliary retransmitter. Specs are: Repeatability, ±1.2 min.; Readability, 0.5 min.; Input Power, 30 va; Size, 1 3/4 x 9 1/2

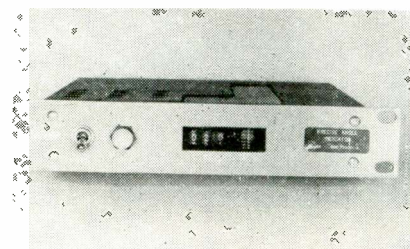

x 9 1/2 in.; Sensitivity, 1.0 min.; Slewing speed, 7 sec./180°; Power (single source), 115 v., 1ø, 400 cps; Weight, 4 lbs. Kearfott Div., General Precision, Inc., 1150 McBride Ave., Little Falls, N. J.

Circle 219 on Inquiry Card

Flexibility and Refinement

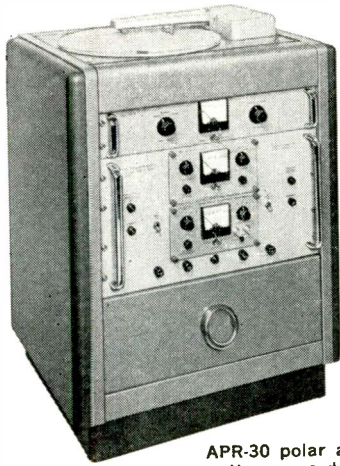

APR-30 polar antenna pattern recorder

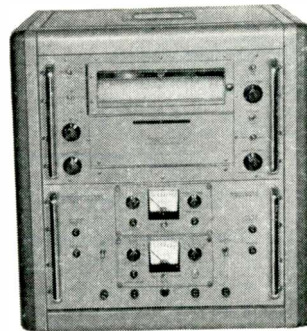

APR-20 rectangular antenna pattern recorder

...The reason
most antenna pattern
recorders
come from



It's the little things that make the difference. Little things, refinements, "extras," and top-notch workmanship all add up to preference for S-A instrumentation.

Things Like Plug-In Balancing Potentiometers ...

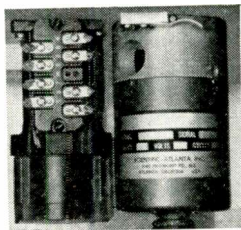

Series P plug-in pen balancing potentiometers

Series P potentiometers are used in both rectangular and polar coordinate pattern recorders. By interchanging potentiometers together with the appropriate pen function amplifier, different responses—linear, square-root, and logarithmic—are obtained. Interchanging these new self-aligning potentiometers can be accomplished in less than thirty seconds. Stocking spare units cuts downtime. Of dust and dirt proof construction, Series P plug-in balancing potentiometers are offered with exchange pricing.

Crystal Bolometer Amplifiers ...

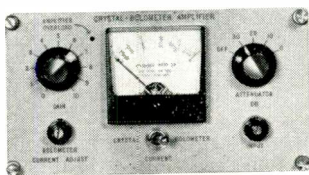

High gain, low noise crystal-bolometer antenna

Sensitive, narrow-band Crystal-Bolometer amplifiers are miniaturized units designed for use as preamplifiers in S-A polar and rectangular pattern recorders. Five models, CBA-21 through CBA-25 are available. Features include bolometer burnout protection, low noise figure, triaxial signal ground return, up to 108 db gain, 80 db linear dynamic range, adjustable bandwidth (CBA-23), high rejection (CBA-24), variable center frequency (CBA-25).

DC Amplifiers ...

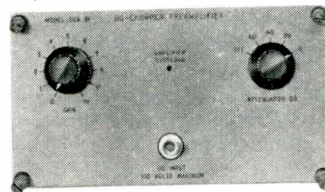

DCA-21 amplifier for dc input signals

Scientific-Atlanta's DCA-21 amplifier lets APR 20/30 recorders accept dc input signals. A narrow band amplifier preceded by an electromagnetic chopper, the sensitive DCA-21 has a linear dynamic range of 80 db. The unit is directly interchangeable with Series CBA-20 Crystal-Bolometer amplifiers.

Recorder Pen Programmers ...

Up to five different pen writing codes can be selected by adding the Model RPP-1 Recorder Pen Programmer to an APR 20/30 installation. Compact, lightweight, and rack mounted, the programmer provides solid line, dot, dash, dash-dot, and space-dot-dot codes at an adjustable code rate of 30 to 90 cycles per minute.

Modification C, Chart Compression ...

Modification C, which must be ordered at the time of recorder purchase, provides both standard and compressed cycle charts from a single APR 20 Rectangular pattern recorder. Standard chart cycle is 20 inches, compressed 8 inches. Compressed recordings are conveniently sized to fit standard 8½ x 11 notebooks and reports.

Chart Paper, Recording Pens, Ink, and Accessories ...

Scientific-Atlanta offers its customers one-day service by stocking, for immediate delivery, a wide variety of chart paper, recording pens, and other recording necessities.

But above all, it's the engineering philosophy of a company run by antenna engineers for antenna engineers.

Call your nearby S-A engineering representative for more information on S-A pattern recorders and accessories. For complete technical information, please write to Box 44.

S-A SCIENTIFIC-ATLANTA, Inc.

2162 Piedmont Road, N.E. • Atlanta 9, Georgia

TRinity 5-7291

See us at the IRE Booth Number 3926 7

LOW ENERGY SURVEY METER

This portable, low-energy sensitive survey meter is for detecting and measuring beta and gamma radiation. The Model 440 has an accuracy of 10% with gamma energy dependence of $\pm 15\%$ from 6.5 Kev to 1.2 Mev.



It uses an air ionization chamber with a 1 mg/cm² Mylar window, measuring radiation directly in milliroentgens. Transistorized printed circuitry operates from 4 D cell batteries. A single control knob turns the instrument On and provides 5 sensitivity ranges of 0-3, 0-10, 0-30, 0-100, 0-300 mr/hr. The Victoreen Instrument Co., 5806 Hough Ave., Cleveland 3, Ohio.

Circle 220 on Inquiry Card

PLANAR TRIODE

A rugged, high-mu, planar triode features compact, coaxial, ceramic and metal construction. Its uses are in grounded-grid service as a r-f amplifier-oscillator, or frequency multiplier up to 4,000 MC. The Mil-6771

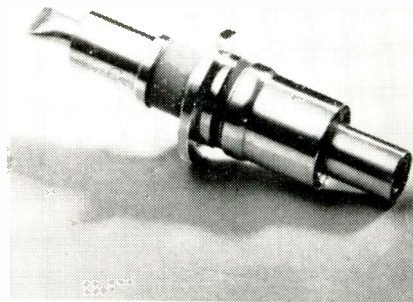

has an indirectly-heated, oxide-coated disc as a cathode, and a heater electrically separated from the cathode. Its features include low inter-electrode capacitances, low electrode lead inductance, and short electron transit time. Cooling of the anode is by conduction and convection. The Machlett Laboratories, Inc., 1063 Hope St., Springdale, Conn.

Circle 222 on Inquiry Card

NUMERIC READOUT

The Bina - View Alpha - Numeric Readout accepts any binary coded decimal code up to 6 bits. It does its own translating, and displays the proper character. It may be connected directly into computers, instruments,

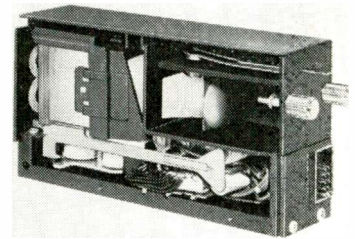

display boards, numerical controls, and other electronic equipment. It may be operated with as little as 10 mw/bit of signal power and will display up to 20 characters/sec. Unit also features character storage. Dimensions are 3 1/4 x 1 1/4 x 6 3/4 in. Weight is approx. 2 lbs. Industrial Electronic Engineers, Inc., 5528 Vine-land Ave., N. Hollywood, Calif.

Circle 224 on Inquiry Card

SCOPE CAMERA

Camera is designed for undistorted viewing and direct recording of oscilloscope traces. The C-12 accepts Polaroid or any conventional film. It uses a unique sliding back (adjustable to horizontal or vertical) on which you can interchange the par-focal, film-holding backs, lock them securely in 5 detent positions and also rotate them thru 90° increments. It uses any of 8 easily-interchangeable lenses. Other features

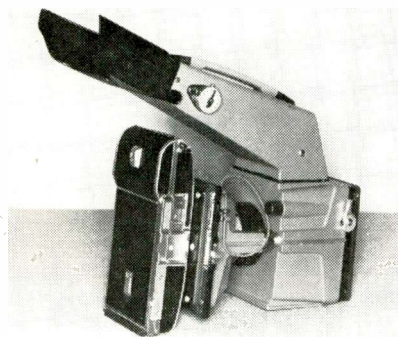

include portability, lift-on mounting, swing-away hinging, and comfortable viewing. Camera accepts a wide range of available accessories. Tektronix, Inc., P.O. Box 500, Beaverton, Ore.

Circle 221 on Inquiry Card

DELAY LINES

Lumped constant delay lines consist of m-derived L-C networks. Each delay line section is specially designed to give linear phase shift beyond 70% of the cutoff frequency. Thus, both the rise time and overshoot of these delay lines are small. They pass all applicable military specs. There is no dc blocking capacitor or terminating resistor in these delay lines; a non-inductive carbon resistor should be used to

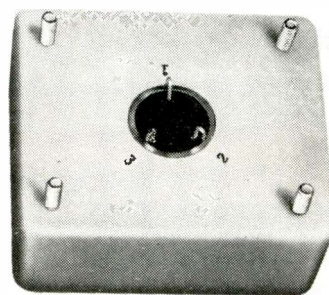

terminate the last section and a blocking capacitor should be connected in series with the input if the source contains a high dc component. HST Div. of Dresser Electronics, 555 N. 5th St., Garland, Tex.

Circle 223 on Inquiry Card

DIFFERENTIAL AMPLIFIER

All-solid state Differential Operational Amplifier, Model P2 contains neither tubes nor mechanical choppers. It is a dc differential amplifier whose input is "floating" and has a long term drift stability in the sub-millivolt region. Typical input current is under 100 p amp. This makes possible its use in long time-constant integrating circuits using small polystyrene capacitors (R = 10 meg, C = 0.1 μ f for a 1 sec. integrator),

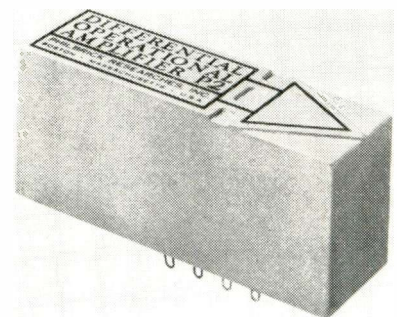

or in electrometer type amplifier circuits. Common mode signal is limited only by dielectric strength of the insulating materials. George A. Philbrick Researches, Inc., 285 Columbus Ave., Boston 16, Mass.

Circle 225 on Inquiry Card

THREE

NEW

BEAM-X[®]

SWITCHES

FILL A WORLD OF DESIGN NEEDS

In countless applications where switching functions exist... counting, distributing, multiplexing, coding, timing, matrixing, converting, and decoding... the BEAM-X switch has revolutionized circuit design. Now the Burroughs Electronic Tube Division has developed a new family of BEAM-X switches to meet varying application requirements. Each switch represents a real savings in cost, size and weight, and provides an increase in circuit performance and reliability.

ANOTHER ELECTRONIC CONTRIBUTION BY
Burroughs Corporation
ELECTRONIC TUBE DIVISION
Plainfield, New Jersey

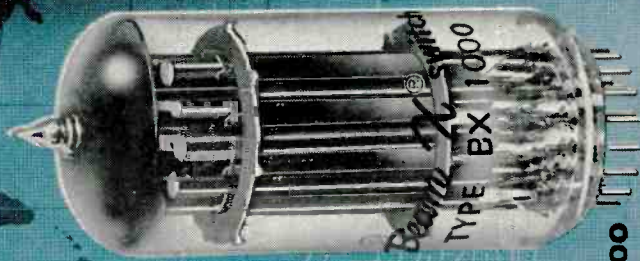

GENERAL PURPOSE TYPE BX-1000

The original BEAM-X switch represents a breakthrough in electronic switching. It is the lowest cost, lightest weight, highest speed, smallest size, 10-position constant current electronic switching device. It has found wide usage in Military Systems, Electronic Instrumentation, Industrial Control, Aircraft and Missiles Systems, and Test Equipment.

WRITE FOR BULLETIN 1000



SHIELDED TYPE BX-2000

The BX-2000 BEAM-X switch is the new magnetically shielded version of the BX-1000. In applications where space conservation is vital, its shielded construction permits the units to be mounted in direct contact. Both the BX-1000 and the BX-2000 feature ten 3 ma. constant current outputs to drive NIXIE[®] tubes, printers, and to perform decimal switching functions.

WRITE FOR BULLETIN 1004

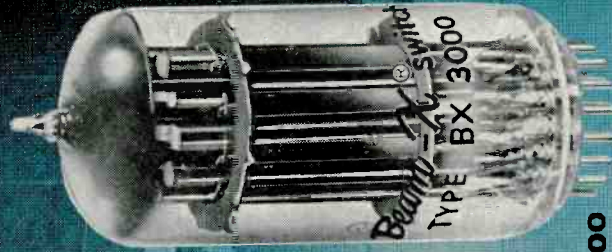

HIGH CURRENT TYPE BX-3000

The BX-3000 BEAM-X switch is especially designed for areas of heavier work load. This device provides ten 5.5 ma. constant current outputs, making it capable of driving multiple NIXIE indicator tubes, both local and remote, relays, printers and perform other circuit functions. The characteristics of low cost, long life, ruggedness, high temperature operation and reliability remain the same, as in all Beam-X Switch types.

WRITE FOR BULLETIN 1005

ILLUMINATED PUSHBUTTON

The oil tight unit combines the functions of a pushbutton and an indicating light. The C-H illuminated pushbutton uses a color-coded, molded type transformer designed to be immune to voltage surge lamp dam-

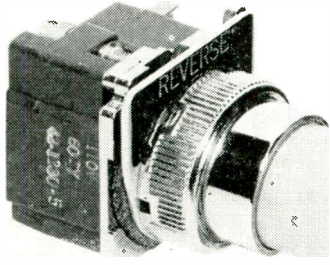

age. It can operate with multiple contact blocks with any combination of N.O. or N.C. contacts. Features include base and 1-hole mounting, functional plastic lenses in red, blue, amber, green, clear or white and a positive mechanical "feel." It is available for 110, 220, 380, 440 and 550 v. applications. Cutler-Hammer, 436 N. 12th St., Milwaukee, Wis.

Circle 226 on Inquiry Card

BALANCED DUPLEXERS

The balanced waveguide duplexers minimize incoming signal loss to the receiver. Other features are matching over a much broader frequency range than is possible with the branched duplexer, and greater protection against receiver crystal burnout. Shown here is a typical X-band duplexer. Similar units are available in L, S, C, Sl, Ku, K and

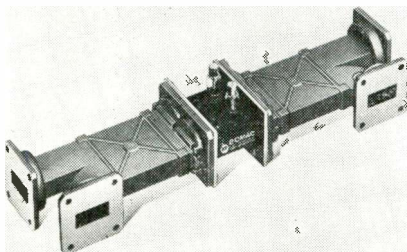

Ka bands. Specs: Freq., 8490 to 9578 MC; transmitter power, 200 kw max.; duplexer loss 1.2 db max.; isolation 10 db min.; VSWR, 1.4 max.; VSWR high level, 1.2 max. Bomac Laboratories, Inc., Salem Rd., Beverly, Mass.

Circle 227 on Inquiry Card

TWT AMPLIFIERS

Two X-band high gain TWTs are capable of 10 to 100 times the average power of conventional helix tubes. The power increase is achieved by use of folded waveguide structures to replace the helix and special periodic

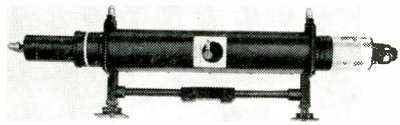

focusing techniques. The 307H (shown) has a 100 kw peak power output (500 w. average) with a minimum of 50 kw over an 8.5-9.5 KMC range. The grid-controlled 308H tube has a 15 kw peak power output (150 w. average) and an 8.6-9.9 KMC range. Hughes Aircraft Co., Microwave Tube Div., 11105 Anza Ave., Los Angeles 45, Calif.

Circle 228 on Inquiry Card

30 MC OSCILLOSCOPE

Model 170A is designed for general purpose measurements. Premium components are used throughout. The oscilloscope has provisions for accepting a complete series of plug-in units. The scope provides 24 calibrated sweep times, 0.1 μ sec/cm to 5 sec./cm, with $\pm 3\%$ accuracy. A 7-range magnifier increases the fastest sweep to 0.02 μ sec/cm. Horizon-

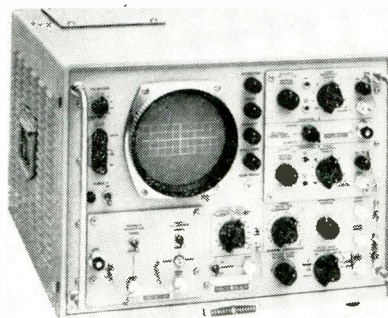

tal amplifier sensitivity is 0.1 v/cm to 10 v/cm. A 9-range internal calibrator provides accurate calibrating voltages from 0.2 mv to 100 v. peak. Hewlett-Packard Co., 1501 Page Mill Rd., Palo Alto, Calif.

Circle 229 on Inquiry Card

SEALED CONNECTORS

The hermetically sealed connector has socket type contacts. The socket contacts are of the closed entry type with a hooded spring, insuring constant spring tension and wiping action. A hermetically sealed connection



is provided since both the socket contact plug and its mating receptacle have full glass inserts. Contacts are identified by permanently imbedded markings. The coupling mechanism is of the thread assist type. This connector, in the mated condition, resists exotic propellant compounds. The Deutsch Co., Municipal Airport, Banning, Calif.

Circle 230 on Inquiry Card

ISOLATION TRANSFORMER

The Model L131 transformer permits isolating from ground a complete instrument or component circuit. The isolation effectiveness is such that signals from dc to several MC can be applied between the chassis of a conventional instrument and ground. Shunt capacitance has been reduced to 40 pf by providing an air gap between the secondary winding and the core.

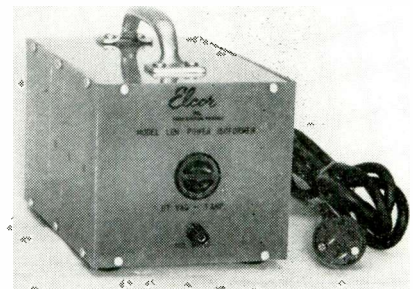

Features of this 350 w. isolation transformer include a leakage resistance value for the secondary winding of 100 kilomegms and a breakdown voltage of 5000 v. Elcor, Inc., Falls Church, Va.

Circle 231 on Inquiry Card



Dear American Airlines:

Your passenger service reflects outstanding selection of personnel. The neat and efficient young ladies in front of the counters are a credit to a company who cares about the customer.

M. J. McDonough

UNSOLICITED IN-FLIGHT LETTER FROM M. J. MCDONOUGH, EQUIPMENT SALES DIVISION, AMERICAN CAN CO.

Our Passenger Service Representatives, Mr. McDonough, are another reason why American Airlines is the *first choice of experienced travelers*. They are "goodwill ambassadors"; experts to the tips of their prim white gloves, roving information specialists who smooth your journeys with a smile. **AMERICAN AIRLINES** *America's Leading Airline*

Call your **hp** rep today for a demonstration of one of these

3

POPULAR



OSCILLOSCOPES



Production or lab instruments—Simple to use, even for non-technical personnel—Moderately priced—Full 10 cm x 10 cm display—Automatic calibration waveforms—Low phase shift—Automatic triggering for optimum presentation—“Times-5” sweep expander magnifies trace, improves resolution.

DC to 200 KC

Models 120A/AR combine minimum controls with Φ automatic triggering for utmost speed, convenience. Horizontal amplifier dc to 200 KC; phase shift only $\pm 2^\circ$ to 100 KC. More X-axis information due to horizontal amplifier sensitivity control, with vernier, 5% accuracy. Balanced input on most sensitive ranges for low level work. Times-5 sweep expander, all ranges. 15 calibrated sweep speeds, 5 $\mu\text{sec}/\text{cm}$ to 0.2 sec/cm. Vernier, expander extend speed range 1 $\mu\text{sec}/\text{cm}$ to 0.5 sec/cm. 10 mv/cm sensitivity calibrated vertical amplifier, drift-free trace. Φ 120A (cabinet) or Φ 120AR (rack), \$450.

DC to 200 KC—DUAL TRACE

Models 122A/AR provide simultaneous two-phenomena presentation, are ideal for direct comparison of filter, amplifier output/input phenomena; vibration testing. Unique Φ front-panel automatic calibrator waveform switch. Twin vertical amplifiers operate independently, simultaneously, differentially. Automatic triggering, automatic synchronization, single trace operation when desired. Sensitivity 10 mv/cm to 100 v/cm, 15 calibrated sweeps, vernier extension. Horizontal amplifier dc to 200 KC. Φ 122A (cabinet) or 122AR (rack), \$675.

DC to 300 KC—“BIG SCOPE” PERFORMANCE

Models 130B/BR provide wide usefulness, simple operation and rugged dependability. 21 calibrated sweep times, 1 $\mu\text{sec}/\text{cm}$ to 5 sec/cm. Vernier, expander extend range 0.2 $\mu\text{sec}/\text{cm}$ to 12.5 sec/cm. Twin horizontal and vertical amplifiers, phase shift $\pm 1^\circ$ to 50 KC; sensitivity 1 mv/cm to 125 v/cm. Balanced input on 6 most sensitive ranges. Common mode rejection 40 db. Stability 1 mv/hour after warmup. Triggering automatic, internally, line power, externally, 0.5 v or greater. Φ 130B (cabinet) or 130BR (rack), \$650.

Data subject to change without notice. Prices f.o.b. factory

Thirteen precision
 Φ oscilloscopes,
dc to 1,000 MC



HEWLETT-PACKARD COMPANY

1050B Page Mill Road
Cable “HEWPACK”

Palo Alto, California, U.S.A.
Davenport 6-7000

Sales representatives in all principal areas

HEWLETT-PACKARD S.A.

Rue du Vieux Billard No. 1
Cable “HEWPACKSA”

Geneva, Switzerland
Tel. No. (022) 26.43.36 6715

New Products

... for the Electronic Industries

DIGITAL VOLTMETER

Applied voltages automatically select appropriate range (± 10 , ± 100 , ± 1000 v.), polarity sign and decimal point. Model 4011 creates a full 4-digit indication of dc voltages with a linearity of 0.01% of full scale.

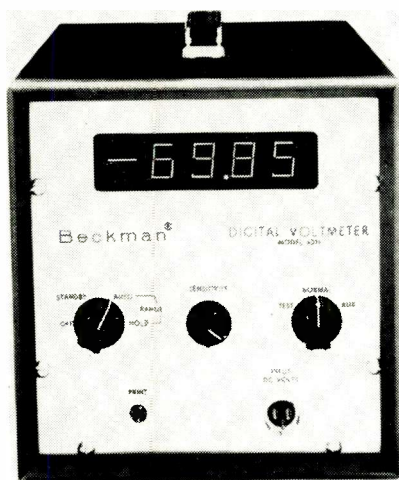

Sensitivity is better than 1 mv. It can be locked into any one of 3 ranges for repeated measurements. Readings are also available in 1-2-4-8 binary-coded signals. Printout of measurements can be made on an associated printer. DVM can be packaged in either an 8 x 8 in. portable rack module or a 5 1/4 x 19 in. rack mount unit. Beckman Instruments, Inc., Berkeley Div., 2200 Wright Ave., Richmond, Calif.

Circle 232 on Inquiry Card

TERMINAL BLOCK

The subminiature terminal block, 409-1802 features faster and easier connections. It is adaptable to aircraft electronic and electrical uses where miniaturization, high vibration, and shock conditions exist. It measures 5/16 in. in width, and can accommodate up to 21 terminals, plus

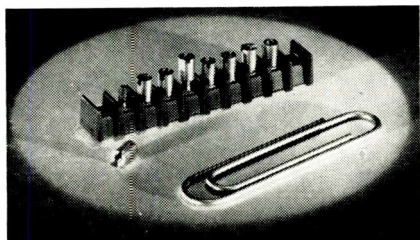

mounting holes, in a length of 4 3/8 in. It offers long leakage paths between terminals. The body material is plastic, meeting Mil-M-14 specs. Kulka Electric Corp., 633-643 S. Fulton Ave., Mt. Vernon, N. Y.

Circle 233 on Inquiry Card

TUNABLE R-F FILTERS

Tunable filters have less than 1.5 db insertion loss. The TTF Series are available in 4 stock models covering 250 to 500 MC, 500 to 1000 MC, 1000 to 2000 MC and 1500 to 2500 MC, each with a 5% bandwidth.

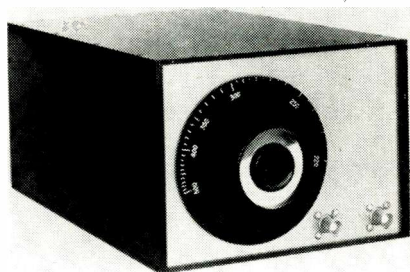

Other frequency ranges and bandwidths are available. The series use 5 resonant line sections, capacity loaded to tune over a 2:1 range. Cabinet models measure 7 x 5 x 10 in.; panel size for mounting is 6 3/4 x 4 3/4 in. They operate at 50 ohms impedance, have a VSWR max. of 1.5:1 and an r-f leakage over 120 db below the input level. Telonic Engineering Corp., Laguna Beach, Calif.

Circle 234 on Inquiry Card

INSULATED CABLE

The cable has been designed for use in air, conduit, underground ducts, or direct burial. The industrial control cable has a chemically cross-linked polyethylene insulation, named Vulkene. It has a high overload rating and is useful where high-ambient temp., high-insulation resistance and



low capacitance are needed. It is available with a 600 or 1000 v. rating, with 2 to 12 conductors, sizes No. 14, 12 and 10 Awg. General Electric, Chemical and Metallurgical Div., Bridgeport 2, Conn.

Circle 235 on Inquiry Card

OSCILLATING UNIT

The subminiature precision fork oscillating unit is for use where size and weight are critical considerations. The unit is bi-metal construction, hermetically sealed; dia 5/8 in., length 2 9/16 in., wt. 2 oz. Termina-



tion is 7-prong miniature base. Wires may be soldered to prongs. Stock frequencies are 400 and 500 cycles. Units are available from 200 to 1000 cycles. Type 25T is for circuits using a germanium or silicon transistor. Type 25V is for use with double triode. Accuracies: R25T and R25V have tolerances of $\pm 0.002\%$ from 15° to +35°C. American Time Products, Inc., 61-20 Woodside Ave., Woodside 77, N. Y.

Circle 236 on Inquiry Card

ALL-METAL DELAY LINES

Helidel® delay lines are 2 in. in diameter. The 8810 Series delay lines are continuously variable, distributed constant units that afford precise selection of very short time intervals. Delay times of 1.0 μ sec to 0.1 μ sec are provided, with rise times less than 10% of total delay time. All

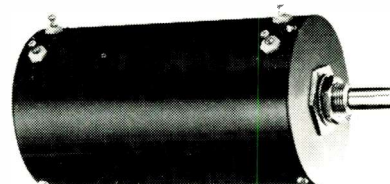

models have an ambient temp. range of -55°C to +80°C, and life expectancy of 1 million or more shaft revolutions. Helipot Technical Information Service, 2500 Harbor Blvd., Fullerton, Calif.

Circle 237 on Inquiry Card

Here's the Inside Story

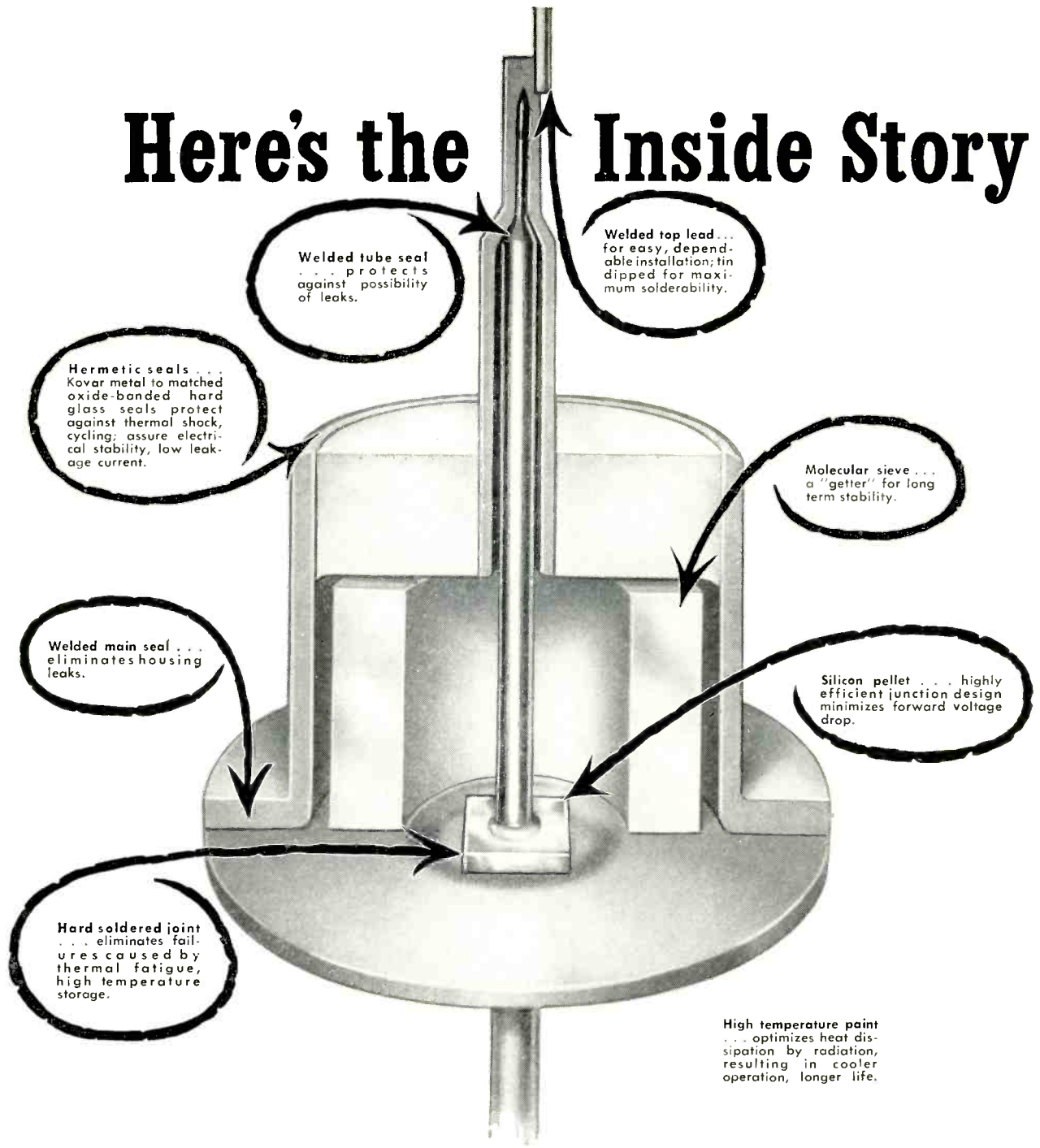

99% SURVIVAL AT 10,000 HOURS! General Electric low current silicon rectifier type 1N538 has gone through torturous life test studies over a period of 10,000 hours at maximum temperature, current, and PRV with a truly amazing survival percentage. But this performance is typical of all General Electric low current silicon rectifiers because reliability is built into every device in the line. Every unit is painted to provide cool operation even at high temperatures. Hard soldered

joints and the Kovar metal-to-glass hermetic seals are but two further examples of careful step by step controls that have earned G-E rectifiers an unequalled reputation for reliability. An average of 16 separate life, electrical, mechanical and environmental tests on every manufacturing lot prove out the quality that has been built in. It's no accident that General Electric low current silicon rectifiers *better* all known existing MIL specs.

Survival Data from Operating and Elevated Storage Tests

Type of Unit	PRV	Current (ma)	Operating Temp. (ambient)	Type of Test	No. of Units	*Percent Survival
1N538 Silicon	200V	250	150°C	Operating at full load and at elevated storage temperature of 175°C ambient	83	99 @ 10,000 hrs.

*Percent survival = $\frac{\text{No. of good units} \times 100}{\text{total no. tested}}$

of General Electric's Low Current Silicon Rectifiers

WITH THESE ADDED FEATURES

Transient PRV ratings provide safer applications. You get the continuous rating you need with protection against occasional transients up to 1200 PRV... at no extra cost.

Maximum forward conductance at high operating temperatures. High current loads are carried without external heat sinks.

Very low leakage makes these devices exceptionally well suited for magnetic amplifier applications.

Minimum forward voltage drop combined with outstanding efficiency of hermetic seal provides unsurpassed reliability.

Conservative ratings — In a recent study G-E devices had the highest resistance to thermal runaway at maximum full load operating temperatures of the products tested.

G-E stud mounted low current silicon rectifiers and the new subminiature silicon glass rectifiers feature the same built-in reliability and performance. Take advantage of the research, advanced development and product design that makes survival rates of 100% a common occurrence, call your G-E Semiconductor Sales Representative today. For additional technical data write Section 24B82, Rectifier Components Dept., General Electric Company, Electronics Park, Syracuse, N. Y. In Canada: Canadian General Electric Company, 189 Dufferin St., Toronto, Ontario. Export: International General Electric Company, 150 E. 42nd Street, New York, New York.

Low Current Silicon Rectifier Cells (Lead Mounted)					
JEDEC & GE Type Number	PRV	Max. I _{dc} @ T°C Amb.	Max. Rev. Cur. (Full Cycle Av.)	Max. Full Load Voltage Drop (Full Cycle Av.)	Max. Oper. °C
1N440	100	@ 50°C	@ 25°C	@ 25°C	150°
1N441	200	300 ma	.3 μa	.65V	150°
1N442	300	300 ma	1.0 μa	.65V	150°
1N443	400	300 ma	1.5 μa	.65V	150°
1N444	500	300 ma	1.75 μa	.65V	150°
1N445	600	300 ma	2.0 μa	.65V	150°
		@ 25°C		@ 200 ma	
1N599	50	600 ma	1.0 μa	.65V	150°
1N599A	50	600 ma	1.0 μa	.65V	150°
1N600	100	600 ma	1.0 μa	.65V	150°
1N600A	100	600 ma	1.0 μa	.65V	150°
1N601	150	600 ma	1.0 μa	.65V	150°
1N601A	150	600 ma	1.0 μa	.65V	150°
1N602	200	600 ma	1.0 μa	.65V	150°
1N602A	200	600 ma	1.0 μa	.65V	150°
1N603	300	600 ma	1.0 μa	.65V	150°
1N603A	300	600 ma	1.0 μa	.65V	150°
1N604	400	600 ma	1.5 μa	.65V	150°
1N604A	400	600 ma	1.5 μa	.65V	150°
1N605	500	600 ma	2.0 μa	.65V	150°
1N605A	500	600 ma	2.0 μa	.65V	150°
1N606	600	600 ma	2.5 μa	.65V	150°
1N606A	600	600 ma	2.5 μa	.65V	150°
		@ 30°C	@ 150°C	@ 150°C	
1N560	800	600 ma	.3 ma	0.5V	150°
1N561	1000	600 ma	.3 ma	0.5V	150°
		@ 50°C	@ 100°C	@ 100°C	
1N1692	100	600 ma	.5 ma	0.6V	115°
1N1693	200	600 ma	.5 ma	0.6V	115°
1N1694	300	600 ma	.5 ma	0.6V	115°
1N1695	400	600 ma	.5 ma	0.6V	115°
1N1696	500	600 ma	.5 ma	0.6V	115°
1N1697	600	600 ma	.5 ma	0.6V	115°
		@ 25°C	@ 25°C	@ 25°C	
1N444B	500	650 ma	1.75 ma	.65V	150°
1N445B	600	650 ma	2.0 ma	.65V	150°
1N440B	100	750 ma	0.3 ma	.65V	165°
1N441B	200	750 ma	0.75 ma	.65V	165°
1N442B	300	750 ma	1.0 ma	.65V	165°
1N443B	400	750 ma	1.5 ma	.65V	165°
		@ 150°C			
1N1100	100	750 ma	.3 ma	.65V	165°
1N1101	200	750 ma	.3 ma	.65V	165°
1N1102	300	750 ma	.3 ma	.65V	165°
1N1103	400	750 ma	.3 ma	.65V	165°
		@ 25°C	@ 125°C	@ 125°C	
1N1487	100	750 ma	.4 ma	.55V	140°
1N1488	200	750 ma	.3 ma	.55V	140°
1N1489	300	750 ma	.3 ma	.55V	140°
1N1490	400	750 ma	.3 ma	.55V	140°
1N1491	500	750 ma	.3 ma	.55V	125°
1N1492	600	750 ma	.3 ma	.55V	120°
		@ 50°C	@ 150°C	@ 150°C	
1N536	50	750 ma	.4 ma	.5V	165°
1N537	100	750 ma	.4 ma	.5V	165°
1N538	200	750 ma	.3 ma	.5V	165°
		(Meets MIL-E-1/1089 (USAF); MIL-E-1/1084A (JAN))			
1N539	300	750 ma	.3 ma	.5V	165°
1N540	400	750 ma	.3 ma	.5V	165°
		(Meets MIL-E-1/1089 (USAF); MIL-E-1/1085A (JAN))			
1N1095	500	750 ma	.3 ma	.5V	150°
1N1096	600	750 ma	.3 ma	.5V	150°
1N547	600	750 ma	.3 ma	.5V	165°
		(Meets MIL-E-1/1089 (USAF); MIL-E-1/1083A (JAN))			

FOR FACTORY-LOW PRICES IN QUANTITIES UP TO 999, SEE YOUR LOCAL G-E DISTRIBUTOR

Progress Is Our Most Important Product

Circle 90 on Inquiry Card

GENERAL  ELECTRIC

New Products

... for the Electronic Industries

VSWR TEST SET

Test instrument determines VSWR and attenuation values of r-f components or circuits. Set uses a pair of coaxial switches operating at 30 CPS to produce a dual scope trace. The 2 traces, representing a reference value

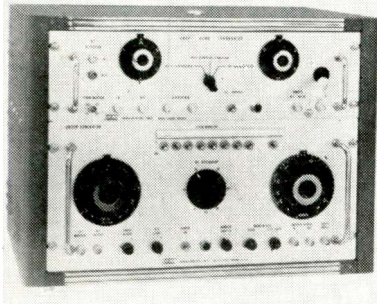

and an unknown, provide instantaneous readings of VSWR or attenuation for the device under test. Model SP 160 covers range of 200 to 475 MC. The generator section has a response flat within 5% over its max. sweep width, an output of over 0.75 v. into 50 ohms, and is equipped with a variable freq. marker. Unit measures 24 x 16 x 16 in. and weighs approx. 85 lbs. Telonic Industries, Inc., Beech Grove, Ind.

Circle 238 on Inquiry Card

SCOPE PLUG-IN

The dual-channel plug-in provides dc to 500 KC bandwidth and 1 mv/cm sensitivity. Type 200 is designed for use with all Analab Oscilloscope Main Frames. The single plug-in unit contains 2 amplifier channels and the

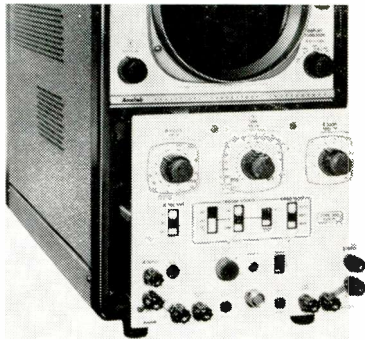

trigger sweep circuits. Channel A has a max. bandwidth of dc to 500 KC and a max. sensitivity of 1 mv/cm; channel B has the same bandwidth and a max. sensitivity of 40 mv/cm. Signals on either channel may be plotted against time or each other. Sweep range is calibrated from 0.5 sec/cm to 1 μ sec/cm in 18 calibrated ranges on a 10 cm time base. Analab Instrument Corp., 30 Canfield Rd., Cedar Grove, N. J.

Circle 240 on Inquiry Card

ION PUMP

The large vacuum ion pump is for use in the ultra-high vacuum field. PDV-300 DriVac pump is an electronic getter-ion pump using a 3-electrode construction. It is well suited for applications such as semiconduc-

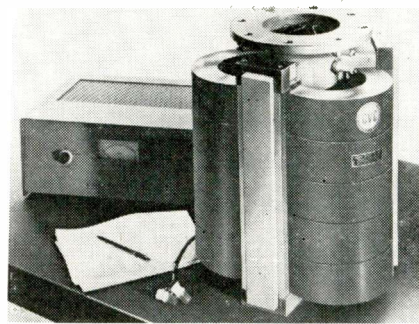

tor processing, vacuum tube processing, electron microscopes, particles accelerators, and field emission, electron beam and molecular beam studies. Pumping speed is 300 liter/sec. with an ultimate pressure of 2×10^{-10} mm Hg. A stainless steel pump casing can withstand bakeout temp. up to 450°C. Sputter-cathode has an expected life of 200,000 hrs. Consolidated Vacuum Corp., 1775 Mt. Read Blvd., Rochester 3, N. Y.

Circle 242 on Inquiry Card

SUBMINIATURE R-F DIODES

A series of subminiature silicon point-contact diodes with all-glass construction are for use in miniature r-f circuitry. The IN830 series are for VHF and UHF video detection and general purpose r-f rectification in coaxial and printed circuit applications. The IN831 series are designed for low-noise r-f mixer applications below 4000 MC. The IN832 series are intended for printed circuit low-noise

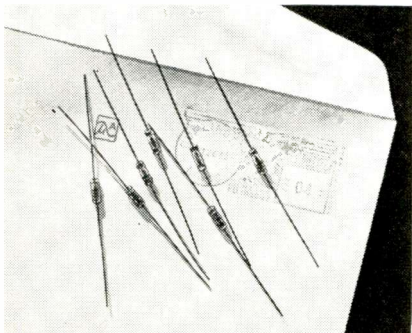

broadband mixer applications between 4000 and 10,000 MC. The IN833 type is intended for low-level detector circuits at all r-f frequencies below 10,000 MC. Microwave Associates, Inc., Burlington, Mass.

Circle 239 on Inquiry Card

TANTALUM CAPACITORS

Non-polar solid tantalum capacitors were developed primarily for ac circuits. The Series N capacitors are made non-polar by the back-to-back connection of 2 Series J solid tantalum capacitors of identical value. Values range from 0.16 to 160 μ f in working voltages of 6, 10, 15, 30, 35, and 50 v. for continuous operation at 85°C. They can be operated at 105°C if the working voltage is de-

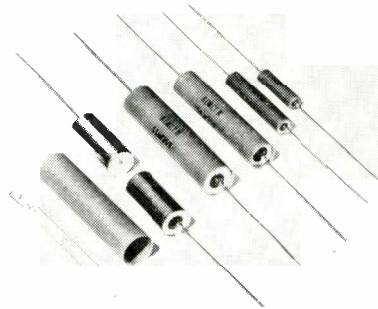

rated to 85% of the 85° value. The capacitors can be used in dc circuits if the combined dc and ac voltages does not exceed the WV rating. Kemet Co., 11901 Madison Ave., Cleveland 1, Ohio.

Circle 241 on Inquiry Card

TRIMMER RESISTORS

Ceramic base units are available for microminiature, subminiature and miniature applications. The single potentiometer type microminiature units are rated at 1/20 w. and measure $\frac{1}{4} \times \frac{1}{4}$ in. The subminiature units are rated at 1/10 w. and measure $\frac{7}{16} \times \frac{13}{32}$ in. in size, and the miniatures, rated 1/5 w. are $\frac{7}{16} \times \frac{11}{16}$ in. All 3 are 0.100 in. thick. Resistances range from 500 ohms to

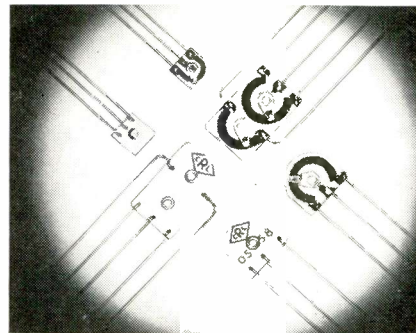

5 megohms, linear taper. Standard tolerance is $\pm 30\%$ although $\pm 20\%$ is available if required. Minimum end resistance is less than 5% of total resistance. Centralab, 900 E. Keefe Ave., Milwaukee 1, Wis.

Circle 243 on Inquiry Card

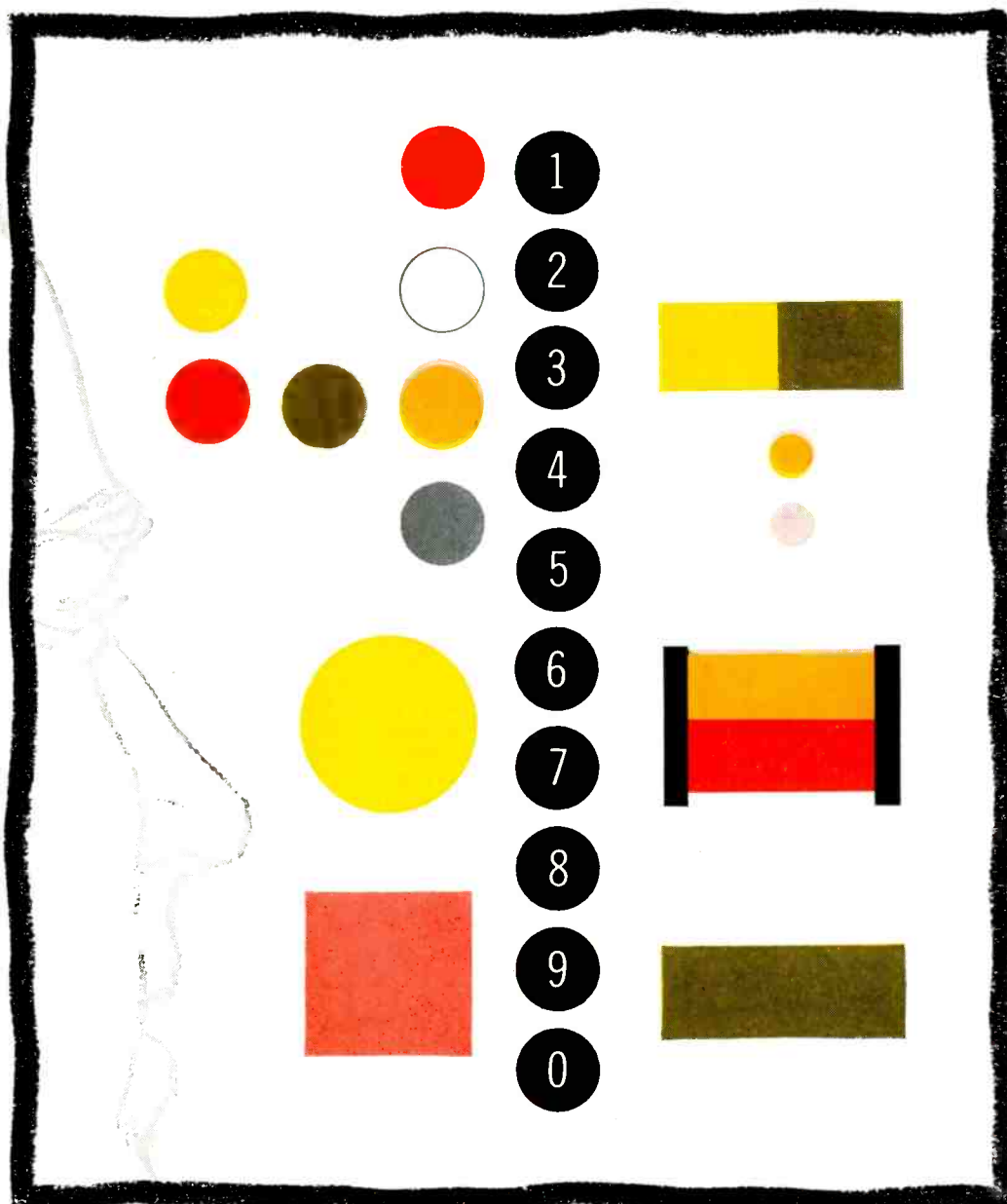

IMPACT!

When a light comes on . . . or changes color . . . it immediately draws attention. Then add operator reaction . . . "hit that light when it turns red!". These are basic elements of today's sophisticated control panels.

Attention and reaction are built into all Control Switch lighted pushbutton switches. Round or rectangular buttons that light up in one, two, three or four colors, with monitor and control of up to four circuits.

For monitoring only, Control Switch indicator lights are available in hundreds of sizes, shapes, colors and circuits.

Write today for technical data on the industry's most versatile and complete line of lighted switches and indicator lights. If you have an unusual panel problem, let us solve it with a custom design.



CONTROLS COMPANY OF AMERICA

CONTROL SWITCH DIVISION
1408 Delmar Drive • Folcroft, Pennsylvania
TELEPHONE Ludlow 3-2100 • TWX 5HRN-H-502

Manufacturers of a full line of switches, controls and indicators for all military and commercial applications. All standard units stocked for immediate delivery by leading parts Distributors.

MECHANICAL FILTERS

Two mechanical filters are especially designed for FM mobile radio equipment. One of the new filters, the F455YA-120, has a 455 KC center frequency and a passband of 12 KC. With this filter, FM mobile re-

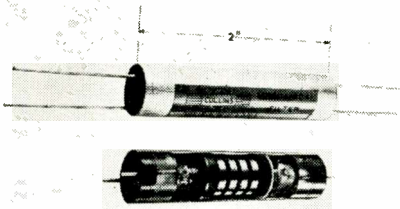

ceivers can be designed to match systems using the ± 5 KC transmitter deviation specified under the FCC split-channel ruling. The other new filter is the F455YA-320 which has a 32 KC band pass and is especially suited for wideband mobile equipment applications. Collins Radio Co., Western Div., 2700 W. Olive Ave., Burbank, Calif.

Circle 244 on Inquiry Card

PRECISION POTENTIOMETERS

They are for use where small increments of shaft rotation must produce proportionally small changes in resistance. The deposited film precision potentiometers provide resolution of better than 0.01%. Potentiometers exhibit good wear and rotational life under severe environmental conditions. The units shown above measure 1 1/16 in. in dia. They are available in single or ganged types with shaft and housing features adaptable for servo or panel mounted applications. Mechatrol, Div. of Servomechanisms, Inc., 1200 Prospect Ave., Westbury, L. I., N. Y.

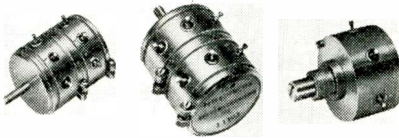

tiometers exhibit good wear and rotational life under severe environmental conditions. The units shown above measure 1 1/16 in. in dia. They are available in single or ganged types with shaft and housing features adaptable for servo or panel mounted applications. Mechatrol, Div. of Servomechanisms, Inc., 1200 Prospect Ave., Westbury, L. I., N. Y.

Circle 246 on Inquiry Card

PLASTIC PROTECTORS

All-around protection for miniature rectangular, electronic connectors is assured during shipment and storage. The close-fitting vinyl caps provide protection from impact damage, keep out moisture, dust and contamination.

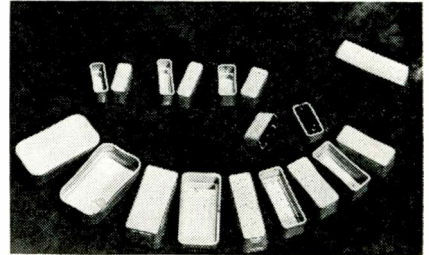

High dielectric strength of vinyl assures insulation against shorting out and the possibility of electrical shock. Protectors are bright yellow and conform to military specs. They are made in 12 sizes, to fit specs. for rectangular connectors (Mil C-8384). Plastics Dept., S. S. White Industrial Div., 10 E. 40th St., New York 16, N. Y.

Circle 248 on Inquiry Card

MINIATURIZED DC MOTOR

New 1 in. dia. dc motor is designed for use in battery powered equipment. Outstanding features of the type HYQM motors are: high efficiency-low current drain for long battery life; square brushes with pigtail connections for long life; available with or without a governor, and standard self-aligning sleeve bearing or ball

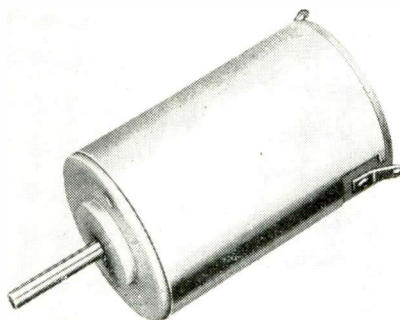

bearings. General characteristics are: 4.5 to 30 vdc; 1,500 to 5,000 rpm (governed); 0 to 0.20 oz.-in. torque; cw or ccw rotation; ambient temp. up to 200°F. Barber-Colman Co., Rock St., Rockford, Ill.

Circle 245 on Inquiry Card

MAGNETIC DRUMS

The complete magnetic drum subsystem includes drum, heads, and associated read-write circuitry. The basic 5 in. drum weighs less than 22 lbs. and rotates at 8,000 rpm. The complete assembly fits into an enclosure 10 in. wide x 7 1/2 in. high. Max. drum capacity is 50 tracks with recirculating registers operating as

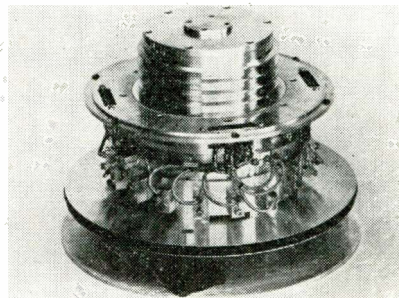

close as 10 bits. An important feature is a new safety system for achieving a constant accurate head-to-drum spacing. Magnetic Head Div. of General Instrument Corp., 3216 W. Segundo Blvd., Hawthorne, Calif.

Circle 247 on Inquiry Card

DC POWER SUPPLY

Model TR-36-2 transistorized dc power supply provides 0-36 v. and 0-2 a. It features remote-sensing, remote-programming, and ready paralleling for increased current ratings. Specs are $\pm 0.03\%$ load regulation, 2 mv peak-to-peak ripple, 50 μ sec. response time for a full load step, and overload protection. Either

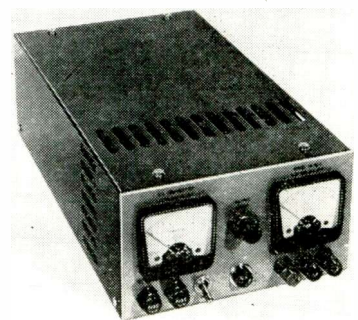

positive or negative output terminal may be grounded. Entire output may be floated 500 v. above or below ground. It measures 4 1/2 x 8 x 14 in. and weighs 15 lbs. NJE Corp., 20 Boright Ave., Kenilworth, N. J.

Circle 249 on Inquiry Card

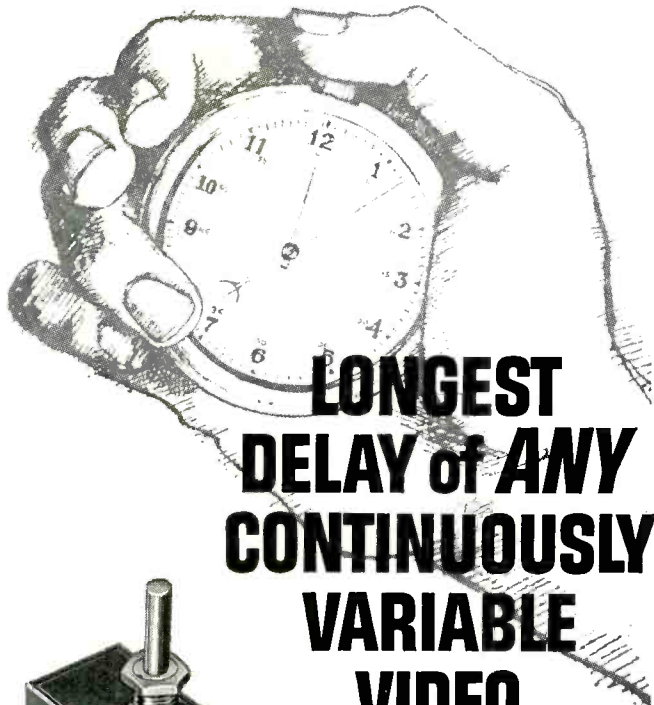

LONGEST DELAY of ANY CONTINUOUSLY VARIABLE VIDEO DELAY LINE!



Actual Size: 7/4" x 1" x 15/8"

ESC's Continuously Variable Delay Line, Series 500, offers maximum flexibility as a laboratory test unit or equipment component. Resolution is better than 1/1000 of maximum delay. Shaft rotation of 10 turns, from zero to maximum delay, is continuously variable.

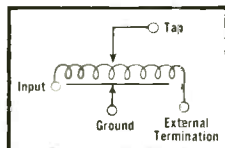

Custom-designed variations are available to meet your most exacting specifications. Locking device or pressure sealed shaft available at no extra cost.

Write today for complete technical data!

Models Available Immediately from Stock

No.	Min. Delay @ Max. Pos.	Impedance (Ohms)	Rise Time* (Max.)	Attenuation
501	.9 usec.	1,000	.2 usec.	.5 db
502	2.0 usec.	470	.40 usec.	1.2 db
503	4.0 usec.	220	.80 usec.	2.5 db
504	9.0 usec.	100	1.8 usec.	5.0 db
505	15.0 usec.	56	3.0 usec.	9.0 db

*Rise time is proportional to delay

exceptional employment opportunities for engineers experienced in computer components... excellent profit-sharing plan.



ESC ELECTRONICS CORP.

534 Bergen Blvd., Palisades Park, N. J.

Distributed constant delay lines • Lumped-constant delay lines • Variable delay networks • Continuously variable delay lines • Step variable delay lines • Video transformers • Filters of all types • Pulse-forming networks • Miniature plug-in encapsulated circuit assemblies • Magnetostrictive delay lines

Circle 92 on Inquiry Card

ALLIED CONTROL'S NEW Polarized Magnetic LATCHING Relay

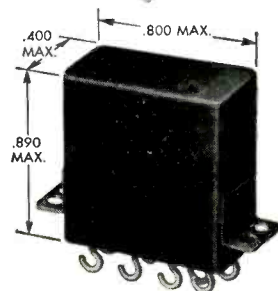

Allied Type JP Relay
Weight: 0.6 ounces
Actual Size

The inherent vibration and shock resistance and high sensitivity of Allied's Type JP *Permanent Magnet* Polarized Latching Relay, combined with its ability to operate from a short pulse and remain operated without holding power, make it suitable for all phases of Aerospace applications.

Because of its latching feature and availability with single or double coils, it is also suitable as a logic or memory switching element in computers and data processing applications.

OPERATING CONDITIONS:

Vibration: 5 to 55 cps at 0.195 inch double amplitude • 55 to 2000 cps at a constant 30g

Shock: 100g operational

Sensitivity: JP (single coil) 115 milliwatt maximum transfer power • JPA-JPB (double coil) 230 milliwatt maximum transfer power

Contact Rating: Non-inductive—2 amperes at 29 volts d-c or 1 ampere at 115 volts a-c
Low level contacts are available on request



ALLIED CONTROL



ALLIED CONTROL COMPANY, INC.

2 EAST END AVENUE, NEW YORK 21, N. Y.

Circle 93 on Inquiry Card

AL 209

for long-life operation
despite extreme temperatures,
heavy shock, severe vibration



CLARE *Type F*

subminiature crystal can

RELAY

This hermetically sealed relay—no bigger than a postage stamp—is a precise component of unusual flexibility, capable of long-life operation under a wide variety of contact loads.

The Clare Type F is extremely fast and more than moderately sensitive. It is built to withstand temperature extremes, heavy shock and extreme vibration. It has proved its usefulness to advanced circuit designers. Contacts, rated at 3 amperes, are excellent for low-level circuit applications. Terminal arrangement is nicely suited to 2/10 inch grid spacing.

In a variety of terminal and mounting designs, the Clare Type F Relay is of real value for both commercial and military applications.



*for complete data on construction, circuitry,
performance characteristics and mountings
...write for Catalog 203*

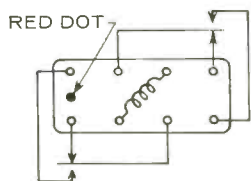
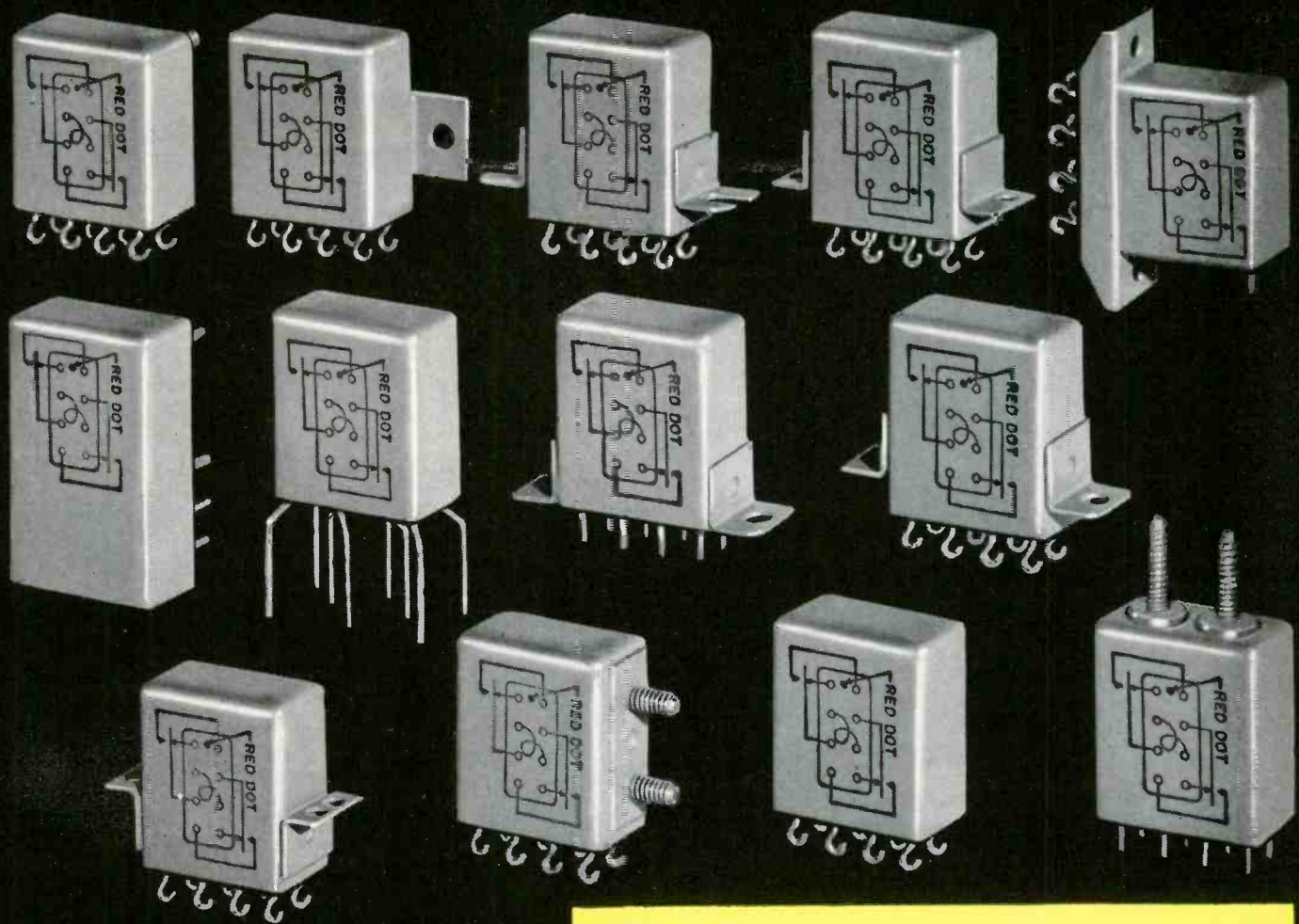

wiring—
as viewed from
terminal end

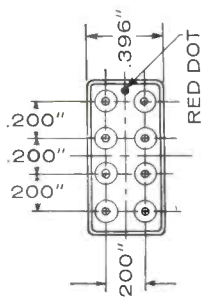
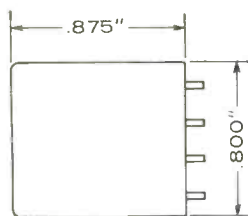

For detailed information, ask your Clare Representative for Catalog 203... or address C. P. Clare & Co., 3101 Pratt Blvd., Chicago 45, Illinois. In Canada: C. P. Clare Canada Ltd., 840 Caledonia Road, Toronto 19, Ont. Cable address: CLARELAY.

SPECIFICATIONS:

Ambient Temperature.....	-65° C to +125° C.
Shock.....	65 G's, 11 millisecond duration.
Vibration.....	5-75 cps at total excursion of 1/8-inch, 75-2000 cps at 20 G's acceleration.
Dielectric Strength.....	Sea level—1000 volts rms between terminals and frame, and between adjacent circuits; 600 volts rms between contacts of a set. At 80,000 ft., 350 volts rms.
Insulation Resistance.....	1000 megohms minimum at 125° C.
Coils.....	Coils from 35 ohms to 10,000 ohms available for a wide range of voltages or currents.
Nominal Operating Power.....	250 milliwatts.
Total Pickup Time.....	5.0 milliseconds.
Total Dropout Time.....	5.0 milliseconds.
Contact Arrangement.....	2 pdt (2 form C).
Contact Rating.....	3 amps resistive at 28 vdc or 1 amp resistive at 115 vac; also for low-level applications.
Contact Resistance.....	0.050 ohm maximum.
Contact Life.....	250,000 operations minimum at 2 amps; 100,000 operations minimum at 3 amps.
Enclosure.....	Hermetically sealed, filled with dry nitrogen at 1 atmosphere pressure.
Mounting.....	All popular mounting arrangements available.
Terminals.....	Printed circuit; solder; plug-in (matching socket available). Variations of printed-circuit terminal length on 2/10 inch grid spacing available.
Weight.....	17 grams.
Military Specifications.....	MIL-R-5757D.

Circle 94 on Inquiry Card



C. P. CLARE & CO. Relays and Related Control Components

HIGH POWER MATCHED PULSE COMPONENTS



Pulse Forming Networks



Pulse Transformers



Charging Reactors



Oscillator Filament
Transformers

FEATURES

- Stable performance at High Temperatures
- Widest Range and combination of Electrical parameters
- Oil filled units hermetically sealed in welded seam cases
- Designed to meet exact system requirements
- Meets and exceeds all Mil requirements

Axel Pulse components are designed for use in Industrial, Military and Research application where electronic equipments demand a specific energy impulse of accurate shape and duration. All Axel Pulse Components have a high reliability and are designed to meet minimum space and weight requirements.

Axel

AXEL ELECTRONICS, INC.
134-20 Jamaica Ave., Jamaica 18, N. Y.

High Voltage Capacitors, Pulse Magnetic Components,
Pulse Networks, Pulse Packages, R.F. Suppression Filters.

New Products

SYNCHRO STANDARDS

Standards are accurate to 2 sec. of arc. They are designed to simulate the output of a master synchro. When driven by a suitable signal source, they provide stator outputs S1, S2 and S3 corresponding to the

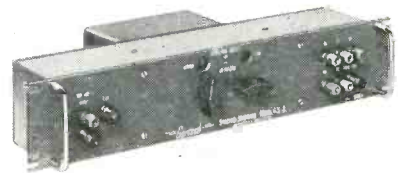

outputs of a master synchro as the shaft is rotated in 5° increments. Quadrant switching is provided to simulate operation over a full 360°. Models SS-1, 2 and 3, feature a low effective series impedance which permits the output to be loaded without introducing stator output errors. Similar units can be supplied as resolver standards. Units available to cover all standard voltages and frequencies. Gertsch Products, Inc., 3211 S. La Cienega Blvd., Los Angeles 16, Calif.

Circle 252 on Inquiry Card

PUSHBUTTON SWITCH

The S6 Series molded pushbutton switch is specifically designed for low power applications. Designed primarily for applications not exceeding 50 w, the switch is ideal for controlling relays, initiating meter

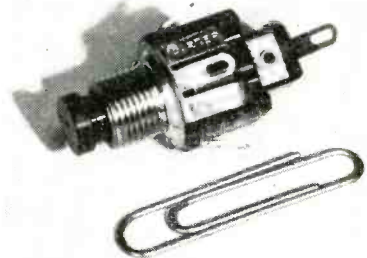

and scope readings, pulsing counters, and panel lights. Available with choice of button colors and in open, closed, and double throw configurations. Carter Parts Co., Dept. 10, 3401 Madison St., Skokie, Ill.

Circle 253 on Inquiry Card

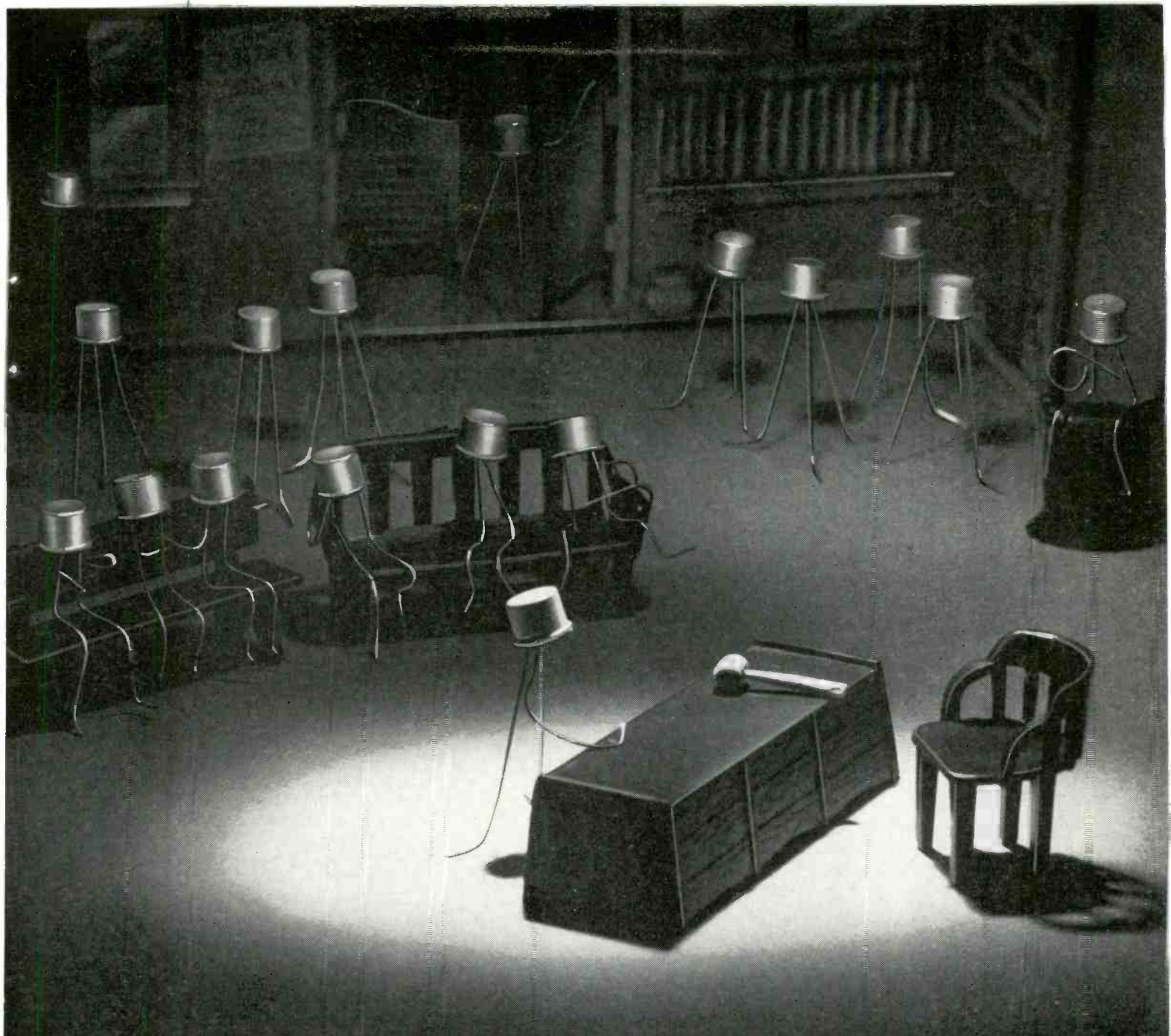

YOU'RE THE CIRCUIT JUDGE...

...and it's up to us to present the facts.

Here's evidence on Sperry's PNP alloy junction silicon transistors:

1. All units are baked at 200°C for 200 hours and each device is doubly tested for a perfect hermetic seal — through a 150°C hot oil check and a separate hydrostatic test at 100 psi.
 2. Sixty-three QC checks are performed before and during mechanized manufacture.
 3. Our newly-built 65,000 square foot facility in Norwalk, Connecticut incorporates the latest techniques to produce the quality and quantity you require.
 4. We offer you a wide variety of PNP types from which to choose.
- May we have your verdict?

SPERRY

SPERRY SEMICONDUCTOR
DIVISION

OF
SPERRY RAND CORPORATION
NORWALK, CONNECTICUT

SEE US AT
BOOTHS 2733-2739
AT IRE SHOW

SEMICONDUCTOR IS OUR MIDDLE NAME . . . SEMICONDUCTOR INTEGRATED NETWORKS (SEMI-NETS)*. TUNNEL DIODES, MESA AND ALLOY SILICON TRANSISTORS AND DIODES. SALES OFFICES: CHICAGO, ILLINOIS; EL SEGUNDO, CALIFORNIA; WESTWOOD, NEW JERSEY; TEWKSBURY, MASSACHUSETTS; STAMFORD, CONNECTICUT; TOWSON, MARYLAND; MASSAPEQUA PARK, NEW YORK. SEMICONDUCTOR OPPORTUNITIES AVAILABLE TO QUALIFIED ENGINEERS

*Trade Mark, Sperry Rand Corporation

“OOOH*
 that
 NEFF
 model 1-101
 DIFFERENTIAL
 DC
 AMPLIFIER ...

... it's
 SOOO isolated!”

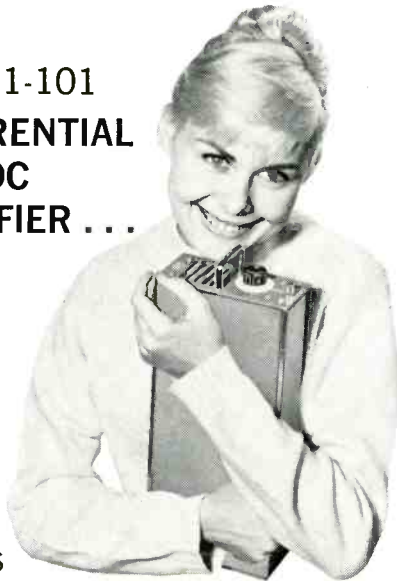

- ↑ DC Common Mode Rejection $10^8:1$
- ↑ ± 10 V @ ± 10 MA output
- ↑ $\pm 0.1\%$ Gain stability
- ↑ Gain 10-1000

***IMPORTANT FOR MULTI-CHANNEL DATA APPLICATIONS: NEW APPROACH TO ECONOMY** improves reliability, eliminates components and provides exceptional performance at less than \$600 per channel.

NEFF

instrument
 corporation

1088 East Hamilton Road
 Duarte, California

New Products

ANALYZER PREAMP

Recording system preamplifier measures strains and low-level electrical parameters simultaneously on separate channels. Industrial Analyzer Model RD 4627 00 adapts medium gain recording systems to a wider



range of recording applications. It permits recording from strain gage and other resistive transducers together with thermocouple, piezoelectric and similar low-level output sensors. Sensitivity of the high gain section is $100 \mu\text{v}/\text{mm}$ chart line, with measurement range from $100 \mu\text{v}$. to 400 v. Unit will accept resistive gages and transducers from 100 to 1,000 ohms. Brush Instruments, Div. of Clevite Corp., 37th & Perkins, Cleveland 14, O.

Circle 254 on Inquiry Card

SILICON RECTIFIERS

The single phase bridge silicon rectifier stacks are mounted on compact dual-fin heat sinks to save space and weight. Measuring $3 \times 3\frac{3}{4}$ in. overall, they are available with current ratings ranging from 5 to 50 a. and with

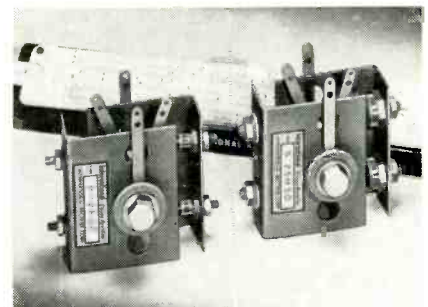

piv ratings from 50 to 500 v. Mounting is rapidly accomplished by a $\frac{3}{8}$ -16 mounting stud, and by connecting leads to terminal lugs on the stack. International Rectifier Corp., 1521 E. Grand Ave., El Segundo, Calif.

Circle 255 on Inquiry Card

ALPHABETICAL LISTING OF

CIRCLE THE NUMBERS OPPOSITE THE NAMES OF THE

- | | | | | | |
|-----|--|-----|---|-----|--|
| 37 | Acme Electric Corporation—Transformers. | 136 | Arco Electronics, Inc.—Capacitor distribution. | 115 | Cambridge Thermionic Corporation—Computer components. |
| 110 | Adams & Westlake Company, The—Mercury-wetted relays. | 158 | Arco Electronics, Inc.—Transformer distribution. | 52 | Cannon Electric Company—Vibration-proof plugs. |
| 43 | Ad-Yu Electronics Lab, Inc.—Phase meters. | 159 | Arco Electronics, Inc.—Transformer distribution. | 280 | CBS Electronic Semiconductor Div.—Power transistors. |
| 14 | Alite Division, U. S. Stoneware—Ceramic-to-metal seals. | 154 | Arnold Magnetics Corporation—Toroidal coil winder. | 83 | Cinch Manufacturing Company—Printed circuit connectors. |
| 48 | Allen-Bradley Company—Low pass filters. | 146 | Avnet—Silicon PNP transistor distribution. | 94 | Clare & Company, C. P.—Subminiature crystal can relay. |
| 49 | Allen-Bradley Company—Variable resistors. | 95 | Axel Electronics, Inc.—Pulse forming networks, charging reactors, and transformers. | 57 | Cleveland Container Company, The—Phenolic tubing. |
| 70 | Allied Chemical Corporation, General Chemical Div.—Electronic chemicals. | | | 101 | Clevite Transistor Products—Transistors. |
| 93 | Allied Control Company, Inc.—Polarized magnetic latching relays. | 71 | Bendix Corporation, The, Electron Tube Div.—Voltage regulator tubes. | 156 | Columbian Carbon Company—Iron oxides for ferrites. |
| 123 | Alpha Metals, Inc.—Flux-filled solder washers. | 60 | Bendix Corporation, The, Scintilla Div.—Special-purpose cables. | 41 | Computer Measurements Company—Frequency meter. |
| 140 | American Airlines, Inc.—Airline transportation. | 114 | Boonton Electronics Corporation—DC meter. | 125 | Conforming Matrix Corporation—Remote masking spray coater. |
| 66 | AMP Incorporated—Connectors. | 21 | Bourns, Inc.—Trimmer potentiometer. | 144 | Consolidated Resistance Company—Resistors. |
| 55 | Ampex Instrumentation Products Company—Special purpose magnetic tape data recorders. | 88 | Breeze Corporations, Inc.—Slip ring assemblies. | 85 | Continental Electronics Manufacturing Company—Radio transmitters. |
| 67 | Amphenol Borg Electronics Corp., Borg Equipment Div.—Digital readout dials. | 81 | Brush Instruments—Direct writing recording systems. | 91 | Controls Company of America, Control Switch Div.—Lighted pushbutton switches. |
| 28 | Amphenol Borg Electronics Corp., Connector Div.—Micro miniature connectors. | 111 | Bulova Watch Company, Electronics Div.—Servo amplifiers. | 109 | Cornell-Dubilier Electronics Div., Federal Pacific Electric Co.—Interference filter. |
| 8 | Amphenol Borg Electronics Corp.—RF Products Div.—Coaxial cable and wire. | 54 | Burnell & Company, Inc.—Toroids, filters and related networks. | 63 | Corning Electronic Components, Corning Glass Works—Wafer capacitor. |
| 278 | Anderson Controls, Inc.—Power surge solenoids. | 87 | Burroughs Corporation, Electronic Tube Div.—Switching tubes. | | |
| 44 | Antenna Systems, Inc.—Antenna systems. | 29 | Busmann Mfg. Company, Div. McGraw-Edison Company—Fuses, clips, blocks & holders. | 98 | Dale Electronics, Inc.—Wirewound resistors. |

YOUR NAME TITLE FEB. 1961
 FIRM
 FIRM ADDRESS
 CITY OR TOWN ZONE STATE

1	2	3	4	5	6	7	8	9	10	11	12	13	14	15	16	17	18	19	20
21	22	23	24	25	26	27	28	29	30	31	32	33	34	35	36	37	38	39	40
41	42	43	44	45	46	47	48	49	50	51	52	53	54	55	56	57	58	59	60
61	62	63	64	65	66	67	68	69	70	71	72	73	74	75	76	77	78	79	80
81	82	83	84	85	86	87	88	89	90	91	92	93	94	95	96	97	98	99	100
101	102	103	104	105	106	107	108	109	110	111	112	113	114	115	116	117	118	119	120
121	122	123	124	125	126	127	128	129	130	131	132	133	134	135	136	137	138	139	140
141	142	143	144	145	146	147	148	149	150	151	152	153	154	155	156	157	158	159	160
161	162	163	164	165	166	167	168	169	170	171	172	173	174	175	176	177	178	179	180
181	182	183	184	185	186	187	188	189	190	191	192	193	194	195	196	197	198	199	200
201	202	203	204	205	206	207	208	209	210	211	212	213	214	215	216	217	218	219	220
221	222	223	224	225	226	227	228	229	230	231	232	233	234	235	236	237	238	239	240
241	242	243	244	245	246	247	248	249	250	251	252	253	254	255	256	257	258	259	260
261	262	263	264	265	266	267	268	269	270	271	272	273	274	275	276	277	278	279	280
281	282	283	284	285	286	287	288	289	290	291	292	293	294	295	296	297	298	299	300
301	302	303	304	305	306	307	308	309	310	311	312	313	314	315	316	317	318	319	320
321	322	323	324	325	326	327	328	329	330	331	332	333	334	335	336	337	338	339	340
341	342	343	344	345	346	347	348	349	350	351	352	353	354	355	356	357	358	359	360
											361	362	363	364	365				

Postcard valid 8 weeks only. After that use own letterhead describing item wanted.

Please send me further information on the items I have circled above.

FIRST CLASS
 PERMIT NO. 36
 PHILA., PA.

BUSINESS REPLY MAIL
 NO POSTAGE STAMP NECESSARY IF MAILED IN UNITED STATES

POSTAGE WILL BE PAID BY
ELECTRONIC INDUSTRIES

The Computer Center
 P. O. Box 8221
 Philadelphia 4, Pennsylvania

- | | |
|-----|--|
| 115 | Cambridge Thermionic Corporation—Computer components. |
| 52 | Cannon Electric Company—Vibration-proof plugs. |
| 280 | CBS Electronic Semiconductor Div.—Power transistors. |
| 83 | Cinch Manufacturing Company—Printed circuit connectors. |
| 94 | Clare & Company, C. P.—Subminiature crystal can relay. |
| 57 | Cleveland Container Company, The—Phenolic tubing. |
| 101 | Clevite Transistor Products—Transistors. |
| 156 | Columbian Carbon Company—Iron oxides for ferrites. |
| 41 | Computer Measurements Company—Frequency meter. |
| 125 | Conforming Matrix Corporation—Remote masking spray coater. |
| 144 | Consolidated Resistance Company—Resistors. |
| 85 | Continental Electronics Manufacturing Company—Radio transmitters. |
| 91 | Controls Company of America, Control Switch Div.—Lighted pushbutton switches. |
| 109 | Cornell-Dubilier Electronics Div., Federal Pacific Electric Co.—Interference filter. |
| 63 | Corning Electronic Components, Corning Glass Works—Wafer capacitor. |
| 98 | Dale Electronics, Inc.—Wirewound resistors. |
| 116 | Davies Molding Company, Harry—Instrument knobs. |
| 64 | Deutsch Company, Electronic Components Div.—Snap-in type connector. |
| 77 | Diamond Tool and Horseshoe Company—Electronic pliers. |
| 141 | DuMont Laboratories, Allen B., Div. of Fairchild Camera and Instrument Corp.—Recording camera. |
| 157 | DuMont Laboratories, Allen B., Div. of Fairchild Camera and Instrument Corp.—Tubes. |
| 62 | Eaton Manufacturing Company—Combination nut and helical spring washer. |
| 145 | EICO Electronic Instruments—Electronics catalog. |
| 134 | Eisler Engineering Company, Inc.—Welding equipment. |
| 72 | Electrical Industries—Glass-to-metal seals. |
| 137 | Electro Motive Mfg. Company, Inc.—Mylar-paper dipped capacitors. |
| 4 | Engineered Electronics Company—Digital system breadboard. |
| 92 | ESC Electronics Corporation—Variable video delay line. |
| 143 | Fairchild Semiconductor Corporation—Planar transistors and diodes. |
| 19 | Fairmount Chemical Company, Inc.—Flux core solder. |
| 108 | Film Capacitors, Inc.—Metallized miniature mylar capacitors. |
| 13 | Fluke Manufacturing Company, Inc., John—Impedance bridge. |
| 38 | Fresno County Assn. of Chambers of Commerce—Industrial plant sites. |
| 25 | Fusite Corporation, The—Glass-to-metal seals. |
| 90 | General Electric Company, Rectifier Components Dept.—Silicon rectifiers. |
| 82 | General Electric Company, Semiconductor Products Dept.—Silicon transistors. |
| 27 | General Instrument Corporation, Semiconductor Div.—Computer semiconductors. |
| 51 | Delco Radio Division, General Motors Corporation—Digital computers. |
| 78 | Delco Radio Division, General Motors Corporation—Digital computers. |
| 149 | General Products Corporation—Aircraft type terminal boards. |
| 3 | General Radio Company—D-C Amplifier and electrometer. |
| 20 | Gertsch Products, Inc.—Frequency meter. |

ADVERTISERS IN THIS ISSUE

ADVERTISERS FROM WHOM YOU DESIRE FURTHER INFORMATION

- 5 Good-All Electric Mfg. Company—Capacitors.
- 281 Graphic Systems—Visual control board.
- 35 Gremar Manufacturing Company, Inc.—RF Connectors.

- 6 Hathaway Instruments, Inc.—Test instruments.
- 138 Helipot Division of Beckman Instruments, Inc.—A-C potentiometers.
- 89 Hewlett-Packard Company — Oscilloscopes.

PROFESSIONAL ENGINEERING OPPORTUNITIES

Circle number of company on card at right from whom you desire further information.

- 501 AC Spark Plug Div. of General Motors Corporation.
- 508 Motorola, Inc.
- 502 National Cash Register Company, Electronics Div.

- 104 Hughes Aircraft Company, Semiconductor Div.—Semiconductor sales.
- 61 Hughes Aircraft Company, Vacuum Tube Div.—Storage tube.

- 182 Industrial Electronic Engineers, Inc.—Digital readout device.
- 33 Industrial Test Equipment Company—Electronic generators.
- 28 Inland Motor Corporation of Virginia, Subsidiary of Kollmorgen Corp.—D-C torque motors.
- 108 Institute of Radio Engineers — IRE Show
- 122 Institute of Radio Engineers — IRE Show.
- 153 Institute of Radio Engineers — IRE Show.
- 46 Institute of Radio Engineers — IRE Show.
- 75 International Resistance Company—Precision power resistors.
- 65 IIT Industrial Products Div.—Large screen oscilloscope.

- 22 Jennings Radio Mfg. Corporation—High voltage vacuum capacitors.
- 279 Johnson Company, E. F.—Nylon connectors.
- 18 Jones Division, Howard B. Cinch Mfg. Company—Plugs & sockets.

- 53 Klein & Sons, Mathias—Electronic pliers.
- 183 Kulka Electric Corporation—Terminal blocks.

- 26 Lenz Electric Manufacturing Company—High voltage lead wire.
- 105 Lepel High Frequency Laboratories, Inc.—High frequency induction heating units.
- 80 Light Electric Corporation — Unitized rectifier.

- 39 McKinstry Metal Works, Inc.—Electrical enclosures.
- 117 Methode Manufacturing Corporation—"Fork" contacts.
- 32 Microwave Associates, Inc., Electron Tube and Device Div.—Coaxial switches.
- 100 Miller Company, J. W.—Molded choke coils.
- 78 Minnesota Mining and Manufacturing Company, Magnetic Products Div.—Magnetic instrumentation tapes.
- 120 Minnesota Mining and Manufacturing Company, Mincom Division—Magnetic tape instrumentation recorder/reproducer.
- 56 Motorola, Incorporated, Semiconductor Products, Inc.—Germanium mesa switching transistor.

Employment—Use the handy card below to get more information on the engineering positions described in the "Professional Opportunities" Section which begins on page 211 of this issue.

Postcard valid 8 weeks only. After that use own letterhead describing item wanted.

FEB. 1961

PROFESSIONAL ENGINEERING OPPORTUNITIES

Please send me further information on the engineering position I have circled below.

501	506	511	516	521
502	507	512	517	522
503	508	513	518	523
504	509	514	519	524
505	510	515	520	525

YOUR NAME TITLE

HOME ADDRESS

CITY or TOWN ZONE STATE

NEW Subscription Order

FEB. 1961

I wish a new complimentary subscription to ELECTRONIC INDUSTRIES Yes No

Company Name:

Name: Position

Company Address:

City: Zone State

Specific Products Manufactured

YOUR NAME TITLE FEB. 1961

FIRM

FIRM ADDRESS

CITY OR TOWN ZONE STATE

1	2	3	4	5	6	7	8	9	10	11	12	13	14	15	16	17	18	19	20
21	22	23	24	25	26	27	28	29	30	31	32	33	34	35	36	37	38	39	40
41	42	43	44	45	46	47	48	49	50	51	52	53	54	55	56	57	58	59	60
61	62	63	64	65	66	67	68	69	70	71	72	73	74	75	76	77	78	79	80
81	82	83	84	85	86	87	88	89	90	91	92	93	94	95	96	97	98	99	100
101	102	103	104	105	106	107	108	109	110	111	112	113	114	115	116	117	118	119	120
121	122	123	124	125	126	127	128	129	130	131	132	133	134	135	136	137	138	139	140
141	142	143	144	145	146	147	148	149	150	151	152	153	154	155	156	157	158	159	160
161	162	163	164	165	166	167	168	169	170	171	172	173	174	175	176	177	178	179	180
181	182	183	184	185	186	187	188	189	190	191	192	193	194	195	196	197	198	199	200
201	202	203	204	205	206	207	208	209	210	211	212	213	214	215	216	217	218	219	220
221	222	223	224	225	226	227	228	229	230	231	232	233	234	235	236	237	238	239	240
241	242	243	244	245	246	247	248	249	250	251	252	253	254	255	256	257	258	259	260
261	262	263	264	265	266	267	268	269	270	271	272	273	274	275	276	277	278	279	280
281	282	283	284	285	286	287	288	289	290	291	292	293	294	295	296	297	298	299	300
301	302	303	304	305	306	307	308	309	310	311	312	313	314	315	316	317	318	319	320
321	322	323	324	325	326	327	328	329	330	331	332	333	334	335	336	337	338	339	340
341	342	343	344	345	346	347	348	349	350	351	352	353	354	355	356	357	358	359	360
361	362	363	364	365															

Postcard valid 8 weeks only. After that use own letterhead describing item wanted.

Please send me further information on the items I have circled above.

- 58 Muirhead & Company, Limited—R.M.S. decade voltmeter.
- 97 Neff Instrument Corporation—Differential DC amplifier.
- 9 Non-Linear Systems, Inc.—Digital voltmeters.
- 36 Nuclear Corporation of America—Radar switch tube.
- 84 Ohmite Manufacturing Company—Variable transformers.

- 127 Pennwood Numechron Company—Digital clock.
- 11 Philco Corporation, Lansdale Div.—Transistors.
- 147 Polarad Electronics Corporation—Antenna pattern microwave receiver.
- 148 Polarad Electronics Corporation—Microwave power source.
- 118 Polyphase Instrument Company—Transistor pulse transformers.
- 131 Power Designs, Inc.—Voltage-current regulators.

- 47 Powertron Ultrasonics Corporation—Ultrasonic cleaning equipment.
- 151 Pyramid Electric Company—Capacitors.

FIRST CLASS
PERMIT NO. 36
PHILA., PA.

BUSINESS REPLY MAIL
NO POSTAGE STAMP NECESSARY IF MAILED IN UNITED STATES

POSTAGE WILL BE PAID BY
ELECTRONIC INDUSTRIES

The Computer Center
P. O. Box 8221
Philadelphia 4, Pennsylvania



FIRST CLASS
PERMIT NO. 36
PHILA., PA.

BUSINESS REPLY MAIL
NO POSTAGE STAMP NECESSARY IF MAILED IN UNITED STATES

POSTAGE WILL BE PAID BY
ELECTRONIC INDUSTRIES

CHESTNUT & 56th STS.
PHILADELPHIA 39, PA.
Chilton Company



FIRST CLASS
PERMIT NO. 36
PHILA., PA.

BUSINESS REPLY MAIL
NO POSTAGE STAMP NECESSARY IF MAILED IN UNITED STATES

POSTAGE WILL BE PAID BY
ELECTRONIC INDUSTRIES

The Computer Center
P. O. Box 8221
Philadelphia 4, Pennsylvania



- 69 Radio Frequency Laboratories, Inc.—AC-DC instrument calibrator.
- 10 Rayclad Tubes, Inc., A subsidiary of Raychem Corp.—Wire capping tubes.
- 15 Raytheon Company, Industrial Components Div.—Subminiature tubes.
- 119 Reeves Hoffman, Div. of Dynamics Corporation of America—Transistorized ovens.
- 30 Reeves Instrument Corporation, A subsidiary of Dynamics Corp. of America—Precision resolvers.
- 128 Rockwell Products Corporation—Blind fasteners.
- 42 Rohn Manufacturing Company—Communication tower.
- 86 Rondo of America, Inc.—Component packaging.
- 112 Rotron Manufacturing Company, Inc.—Miniature fans.
- 1 Sangamo Electric Company—Magnetic tape recorder/reproducer.
- 142 Saratoga Semiconductor Div., Espey Mfg. & Electronics Corp.—Zener voltage regulator.
- 69 Sarkes Tarzian, Inc.—Silicon voltage regulators.
- 283 Scientific-Atlanta, Inc.—Antenna pattern recorders.
- 284 Selectrons, Ltd.—Silver plating.
- 74 Shallcross Manufacturing Company—Test instruments.
- 12 Shockley Transistor, Unit of Clevite Corp.—4-layer diode.
- 40 Shure Brothers, Inc.—Communications microphone.
- 102 Sifco Metachemical, Inc.—Electroplating equipment & chemicals.
- 79 Spectrol Electronics Corporation—Trimming potentiometer.
- 96 Sperry Rand Corporation, Semiconductor Division—Silicon transistors
- 2 Sprague Electric Company—Electrolytic capacitors
- 7 Sprague Electric Company—Germanium transistors.
- 68 Sprague Electric Company—Deposited carbon resistors.
- 150 Stanpat Company—Drafting aid.
- 130 Stewart Engineering Corporation—Backward wave oscillator.
- 106 Stromberg-Carlson, Div. of General Dynamics—Telephone-type relays.
- 113 Sylvania Electric Products, Inc.—Counter tubes
- 155 TA Mfg. Corporation—Instrument cases.
- 76 Tektronix, Inc.—Oscilloscope camera.
- 99 Thomas & Betts, Ltd.—Solderless connectors.
- 34 Transition Electronic Corporation—Mesa micro-transistor.
- 16 Tung-Sol Electric, Inc.—Germanium transistors.
- 107 Ungar Electric Tools, Inc.—Soldering iron.
- 121 Ungar Electric Tools, Inc.—Soldering iron.
- 152 Ungar Electric Tools, Inc.—Soldering iron.
- 45 Ungar Electric Tools, Inc.—Soldering iron.
- 126 United International Dynamics Corporation—Tube sockets.
- 31 United Van Lines—"Pre-planned" moving.
- 129 U. S. Components, Inc.—Miniature connectors.
- 124 Vardex Corporation—Sleeving and tubing.
- 282 Varian Associates—Amplifier klystron.
- 139 Vector Electronic Company—Pre-punched terminal board.
- 50 Victoreen—Voltage regulator tubes.
- 17 Waveline, Inc.—Waveguide switches.
- 24 Weldmatic Division, Unitek—Electronic welding equipment.
- 135 Xcelite, Inc.—Industrial hand tools.

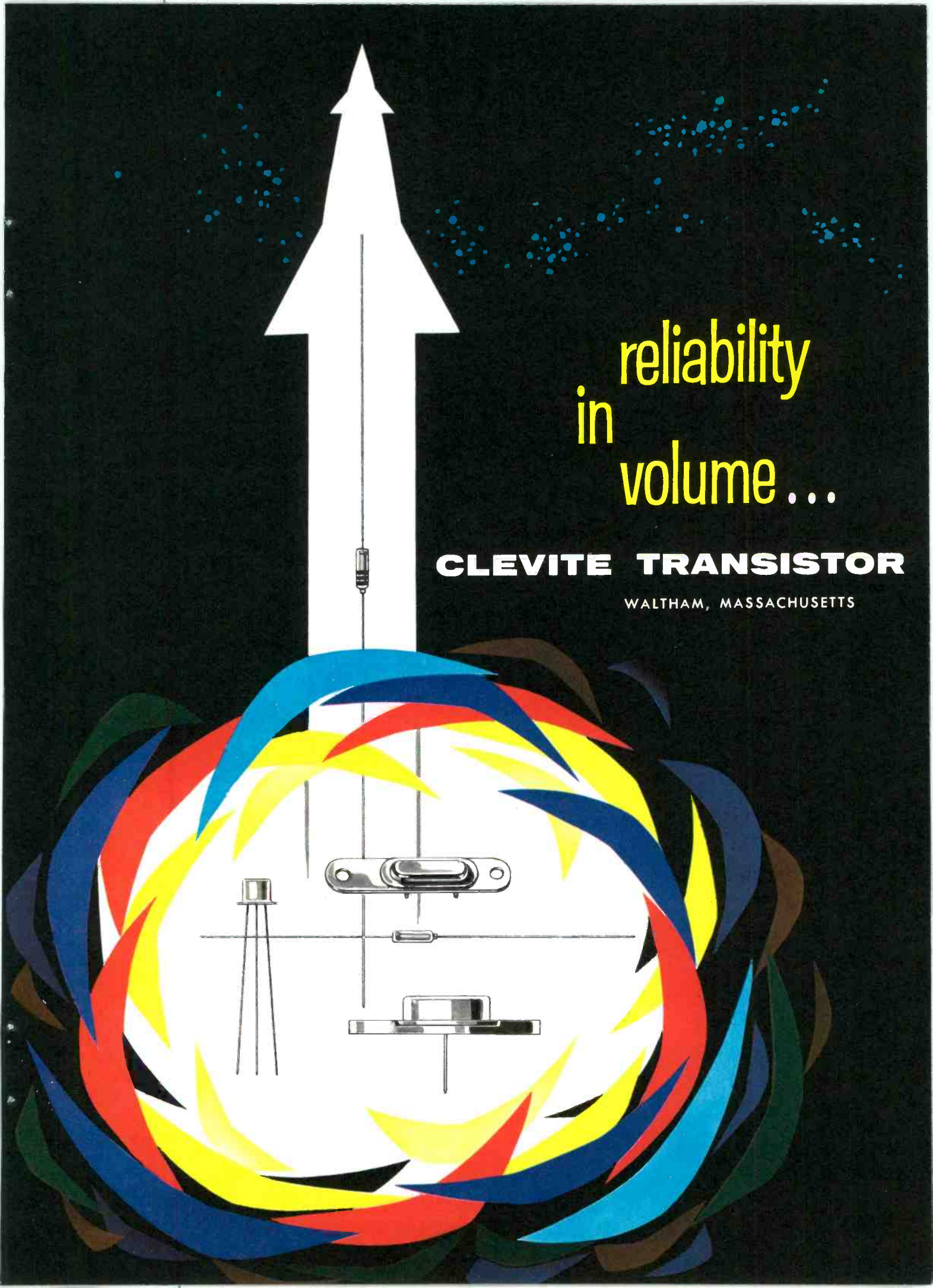

reliability
in
volume ...

CLEVITE TRANSISTOR

WALTHAM, MASSACHUSETTS

How to establish rating values for power transistors

by **RICHARD F. MOREY, JR.**

Manager, Applications Engineering, Clevite Transistor
Division of Clevite Corporation

Every manufacturer of power transistors provides information on the various circuit valves within which a given transistor will satisfactorily perform. These valves or "ratings" are established on the absolute maximum system and are defined so that "the rating values, if exceeded, will cause permanent impairment of the device." Since permanent damage can occur as a result of exceeding rating limits or as a result of an unqualified rating, Clevite Transistor exercises great care in the development of ratings and the proof of their validity.

Clevite places particular emphasis on ratings for junction temperature, power dissipation, collector current, and collector voltage. Each of these ratings is independent and it is not generally possible to approach more than one rating simultaneously. Therefore, specific tests are performed such as "thermal resistance" to establish maximum power dissipation and collector diode leakage current I_{CBO} at both room temperature and high operating temperature to establish maximum rated collector to base voltage. Figure 1 is a diagram of the Thermal resistance test, while Figure 2 indicates the testing configuration for establishing essential collector to emitter voltage ratings.

Other tests are performed to determine collector current and junction temperature. High-temperature-storage life tests to establish maximum junction temperature are further supplemented by Clevite's process of aging transistors at temperatures in excess of the eventual maximum rating.

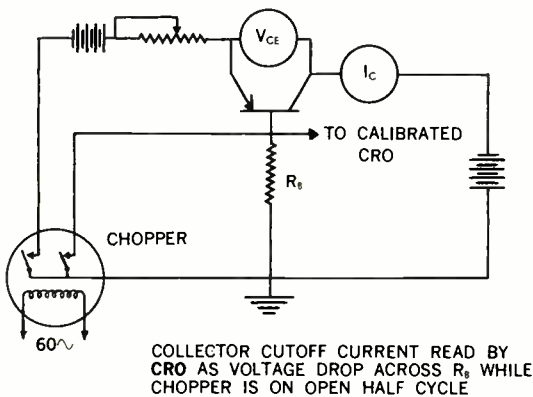

Fig. 1. Thermal resistance test

Perhaps the most important tests are the collector to emitter breakdown tests ($V_{CES(sus)}$ and $V_{CEO(sus)}$) which are used to determine the maximum collector to emitter voltage. Figure 3 indicates a typical germanium power transistor operating in breakdown region. Observe that the bias applied between emitter and base differs for each of the seven curves. This bias differential causes the

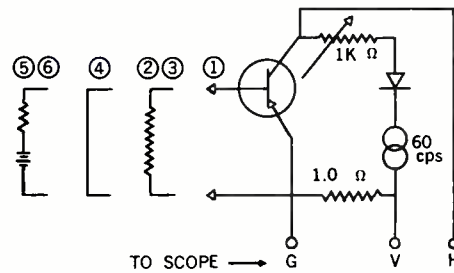

Fig. 2. Collector to emitter voltage test

curves to differ significantly. Curve 1 breaks down sharply at 45 volts, while curve 6 breaks down initially at 118 volts, but upon transversing the curve, the voltage drops and another breakdown occurs at a point slightly greater than 60 volts. Curves 2, 3, 4, and 5 are somewhere between.

Curve 7 is simply the curve of the collector to base diode and is shown here for reference purposes.

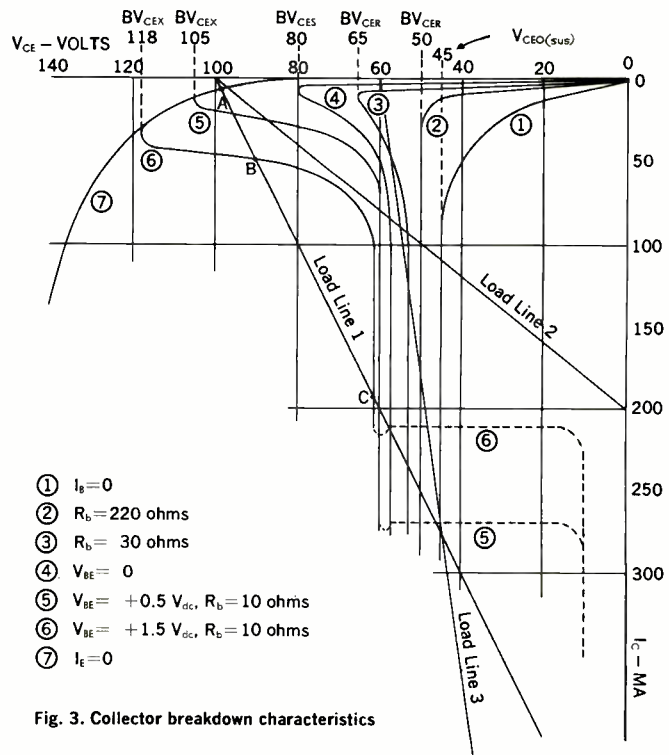

Fig. 3. Collector breakdown characteristics

It may be noted in a particular instance, such as curve 1, that at some voltage (in this case 45 volts) collector current increases without limit. This is the voltage at which collector multiplication causes the overall current gain (α) to equal unity.

The remaining curves serve to indicate the effect of a change in bias at different voltage and current conditions.

The tests and data shown here are only a segment of the total program undertaken by Clevite Transistor to assure a continuous high standard of product quality... "reliability in volume."

Detailed Technical Data Bulletins are available on all Clevite's Power Transistors and Diodes. To obtain technical information, please request Application Bulletins 1 & 2.

DALIC SELECTIVE PLATING
for **ELECTRONIC COMPONENTS**

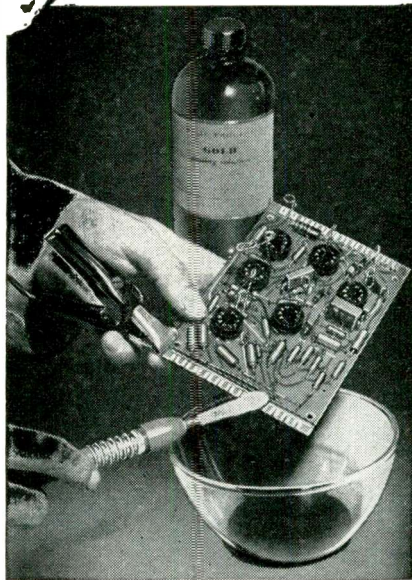

Plating circuit contacts without dismantling electronic components.

Quick Accurate Way to Plate:

- Semi-Conductors.
- Flexible Circuits.
- On site field repair of Electronic Computer Contacts.

Speeds Production in:

- Automatic plating of Transistor Tabs.
- Gold-plating on Aluminum.
- No-flux soldering on Aluminum and Stainless Steel.

Plate selected areas rapidly without disassembling components. Dalic Process accurately controls thickness of deposits. Produces quality plating.

No Immersion Tanks. Mobile Equipment.

Plating equipment can be moved to the job. Quick, easy to use with Dalic hand-stylus, power pack, and the Dalic plating solutions. Mechanized production can be devised.

Write for Descriptive Brochure.

SIFCO METACHEMICAL, INC.

935 East 63rd Street • Cleveland 3, Ohio
A Subsidiary of
The Steel Improvement & Forge Co.

AGENTS

PIDDINGTON & ASSOCIATES LTD. 3219 East Foothill Blvd. Pasadena, California
HYDRITE CHEMICAL CO. 405 South 12th Street Milwaukee 4, Wis.

O & S AVIATION CO., LTD. 671 Laurentides Blvd. Pointe Claire, Montreal, Quebec

Circle 102 on Inquiry Card

← Circle 101 on Inquiry Card

New Products

10 MC COUNTER-TIMER

The counter-timer operates in any of 9 functional modes. Model 365 is completely transistorized. It performs the following measurements: Totalizes random events over any of 9 time intervals from 0.1 μ sec to 100



sec. and any multiple of 10 sec. (extended time base); straight counts with a capacity of 9,999,999; frequency, from 10^{-7} to 10 sec.; time interval from 0.1 μ sec to 100 sec. in 9 ranges in decade steps. Period measurements from 0.1 μ sec to 10^8 sec. Frequency ratio; Phase angle; Pulse-width; Velocity; RPM; Viscosity, and others. Counter range is 1 CPS to 10 MC (sine waves) and 0- 10^6 pps (pulses) without heterodyning or use of plug-in units. Transistor Specialties, Inc., Terminal Dr. Plainview, L. I., N. Y.

Circle 250 on Inquiry Card

DIODE CLASSIFIER

Model 1820 Automatic Diode Classifier classifies diodes in excess of 1200/hr. The diodes are fed into a conveyor system in the oven unit, brought up to temperature and tested for reverse leakage characteristics at various voltages. They are ejected

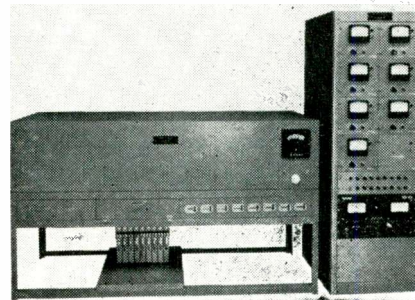

into the correct bin and counted. Shorted and open diodes are also separated. The test temp. of the oven is adjustable to 200°C. Dynatran Electronics Corp., 178 Herricks Rd., Mineola, N. Y.

Circle 251 on Inquiry Card

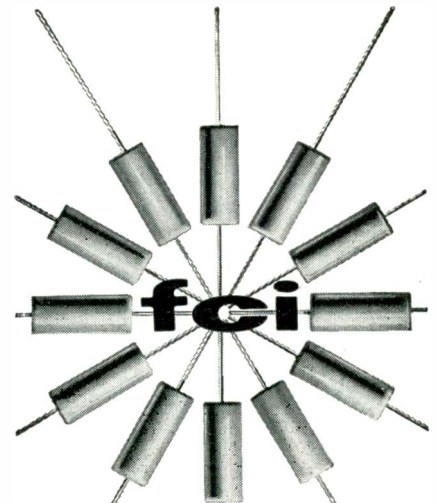

SELF-HEALING METALLIZED MINIATURE MYLAR CAPACITORS

...the ultimate in precision self-healing capacitors

FCI presents a wide range of new metallized mylar capacitors employing the principle of self-healing. These capacitors offer the ultimate in miniaturization and reliability. They can withstand operating temperatures up to 125°C without derating.

Standard units are available up to 600 VDC in any capacity desired and have insulation resistance of 25,000 megohms per microfarad.

The new FCI Self Healing Metallized Mylar Capacitors are furnished in bathtub cases, CP70 cases, or metal shell cases. A typical size is a 4MFD/400 VDC capacitor in a hermetically sealed metal shell
1 1/8" O. D. by
2 1/4" L.



FILM CAPACITORS, INC.
3404 PARK AVENUE • NEW YORK 56, N. Y.

A full line of industry standard metallized paper capacitors are also available.

Circle 103 on Inquiry Card

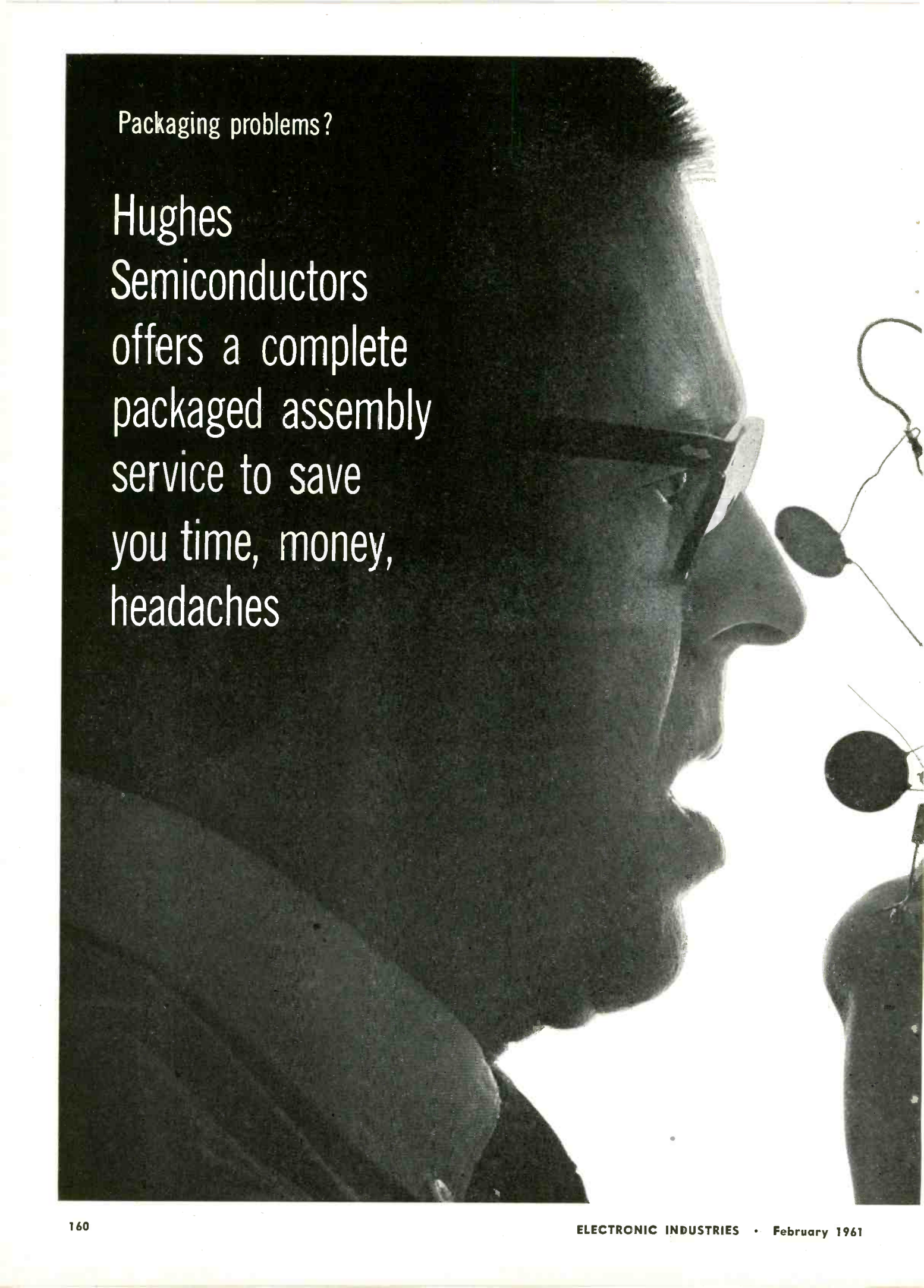

Packaging problems?

Hughes
Semiconductors
offers a complete
packaged assembly
service to save
you time, money,
headaches

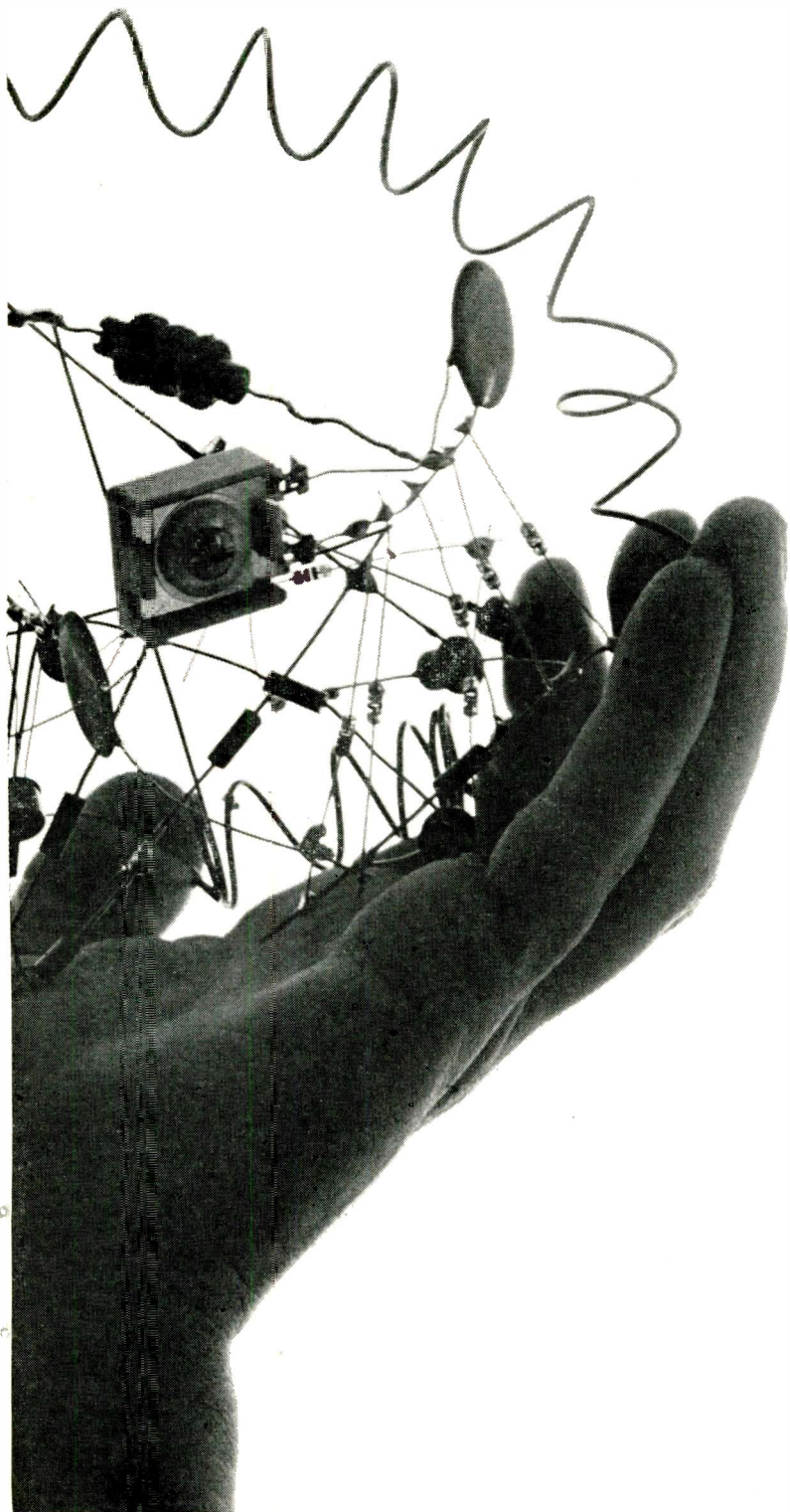

Here are the features of this service:

- 1. SEPARATE PACKAGING DEPARTMENT** — This department specializes in the design and production of special assemblies. It is headed by an engineering group that provides personalized service with emphasis on solving your packaging problems quickly and economically.
- 2. LONG EXPERIENCE** — Hughes has already delivered over a million packaged assemblies. We've produced over 600 standard and special designs for firms all over the country.
- 3. QUALITY COMPONENTS** — Our assemblies consist of only the highest quality active and passive components manufactured by Hughes Semiconductors and other reliable sources.
- 4. RELIABILITY** — Hughes packaged assemblies use self-extinguishing epoxy throughout. They are corrosion proof, hermetically sealed, and their marking ink is immune to normal solvents. Hughes assemblies meet the requirements of all applicable MIL specifications.

If you are looking for a special assembly to fill your specific needs, or if you are looking for a standard assembly, specify Hughes. These assemblies are always rugged, reliable, economical, and you'll like the complete service you get.

Call or write your nearest Hughes Semiconductor Sales Office. Or write: **Hughes Semiconductor Division**, Marketing Department, 500 Superior Avenue, Newport Beach, California.

Creating a new world with Electronics

HUGHES

HUGHES AIRCRAFT COMPANY
SEMICONDUCTOR DIVISION

Lepel

HIGH FREQUENCY
Induction
HEATING
UNITS

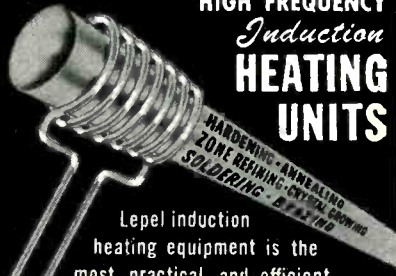

Lepel induction heating equipment is the most practical and efficient source of heat developed for numerous industrial applications

Typical Induction Heating Applications

Glass to Metal Seals

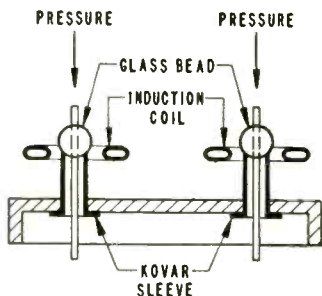

Induction heating is ideal for the assembly of glass beads to pre-oxidized Kovar metal sleeves for a header sub-assembly. The glass-Kovar joint area is brought to 1550° F while pressure is applied to the glass beads.

Our engineers will process your work samples and return the completed job with full data and recommendations without cost or obligation.

Production Soldering Resistors With Long Pigtails

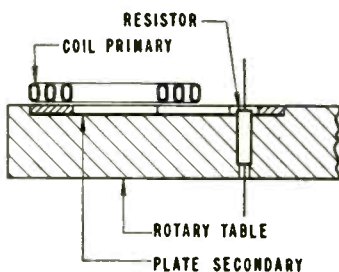

Heating occurs in small opening of plate secondary which is electromagnetically coupled to stationary primary. This produces highly localized heating while avoiding interference of pigtail with the coil. One turntable contains a number of loading positions.

WRITE FOR NEW LEPEL CATALOG

Lepel HIGH FREQUENCY LABORATORIES, INC.

55th ST. & 37th AVE., WOODSIDE 77. N. Y.
CHICAGO OFFICE: 6246 WEST NORTH AVE.

Circle 105 on Inquiry Card

New Products

TUNABLE FILTERS

Microwave tunable band-pass filters range from 500 mc to 18,000 mc. The units feature single-knob tuning of 2-, 3-, and 4-section cavities, a selection of rejection characteristics, and low insertion loss. 81 models

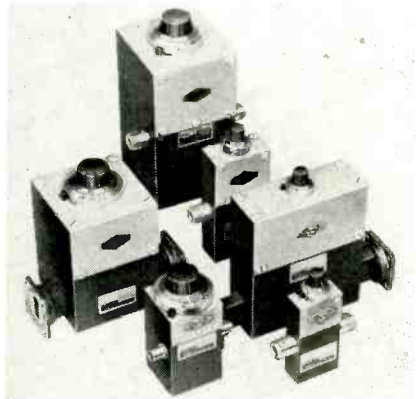

cover UHF, L, S, C, X, and Ku Bands. These models are designed for laboratory applications such as image filters and spectrum analysis. They are also designed for systems applications such as video or superheterodyne preselection; resonant diplexing and band elimination. John Gombos Co., Inc., Webro Rd., Clifton, N. J.

Circle 256 on Inquiry Card

TUNABLE INDUCTORS

Eleven models of a small, stable, tunable inductor have been standardized. Each has outside dia. of only 0.275 in. The 11 models have a nominal inductance range of 0.03 to 0.40 μ h, with an adjustment range of approx. $\pm 10\%$. Minimum Q ranges from 120 to 220, depending on frequency and inductance value. With

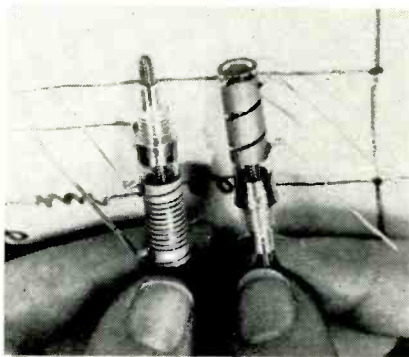

brass core retracted, temp. coefficient is approx. ± 10 ppm/°C. Ideal operating characteristics lie between 10 and 250 mc. Max. current rating is 0.5 a. Corning Glass Works, Corning, N. Y.

Circle 257 on Inquiry Card

Relays by Stromberg- Carlson

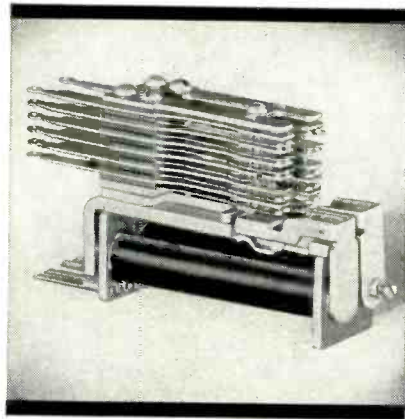

Telephone-type quality • reliability durability

If you require reliable, durable, top quality relays in the equipment you manufacture, you're well advised to consider the relays made by Stromberg-Carlson.

Hundreds of companies have found here the advantages based on our over sixty years of specialization in providing equipment and parts to the independent telephone world.

What's more, we go beyond just the manufacture of relays. If you desire, we can also provide wired mounting assemblies.

Our relays are available in a wide range of types, of which these are representative:

TYPE A: general-purpose. Up to 20 Form "A" spring combinations.

TYPE B: gang-type. Up to 60 Form "A" spring combinations.

TYPE BB: up to 100 Form "A" springs.

TYPE C: (illustrated) two on one frame. Ideal where space is tight.

TYPE E: characteristics of Type A, plus universal mounting. Interchangeable with other makes.

Types A, B, and E are available in high-voltage models. Our assembly know-how is available to guide you in your specific application.

Details on request from these Stromberg-Carlson offices: Atlanta—750 Ponce de Leon Place N.E.; Chicago—564 W. Adams Street; Kansas City (Mo.)—2017 Grand Avenue; Rochester—1040 University Avenue; San Francisco—1805 Rollins Road.

STROMBERG-CARLSON
A DIVISION OF
GENERAL DYNAMICS

Circle 106 on Inquiry Card

New

Products

LOW IMPEDANCE DIODE

The low dynamic impedance 6.2 v. temperature-compensated zener diode is designed for ultra-stable reference applications. It is well suited for digital voltmeters, precision high-stability oscillators, analog to digital

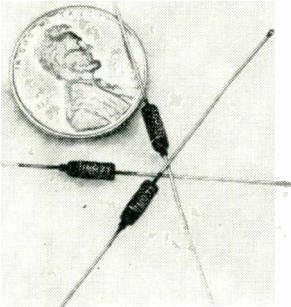

converters, and similar industrial applications. With the low dynamic impedance characteristic, the 1N821A minimizes voltage fluctuations due to changes in current. It has a max. impedance of 10 ohms, and a typical value of 8 ohms. Motorola Semiconductor Products, Inc., Tech. Information Center, Dept. TC, 5005 E. McDowell Rd., Phoenix, Ariz.

Circle 258 on Inquiry Card

ELAPSED TIME METER

Type BH-351 comes, with or without a reset knob, for mounting from the front or back of a panel. It indicates total time a particular circuit is energized. Applications are tube replacement programs and maintenance scheduling of electrical equip-

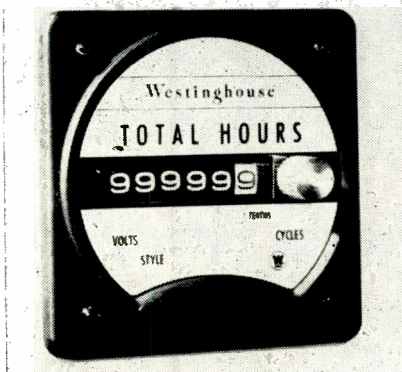

ment. Six register wheels give indications up to 99,999.9 hrs. Digits are white on black background except the tenths digit, which is black on white. Westinghouse Electric Corp., P. O. Box 2099, Pittsburgh 30, Pa.

Circle 259 on Inquiry Card

Old Fashioned?

See what **Ungar** does to soldering tools next month!

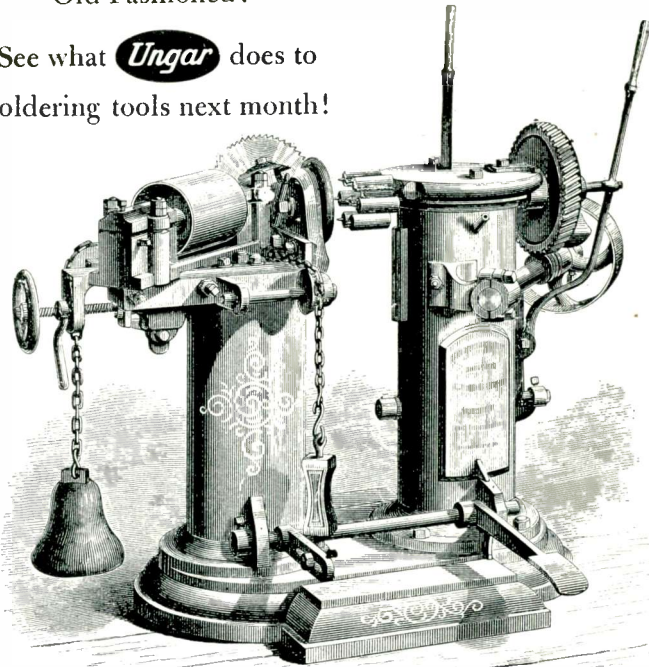

*Machine for Rounding Heads of all sizes
for Kegs and Barrels • E. & B. Holmes • Circa 1870*

Circle 107 on Inquiry Card

For that



NEW IDEA

visit the

IRE SHOW

March 20-23, 1961

New York

Coliseum and Waldorf-Astoria Hotel

Members \$1.00, Non-members \$3.00

Age limit—over 18

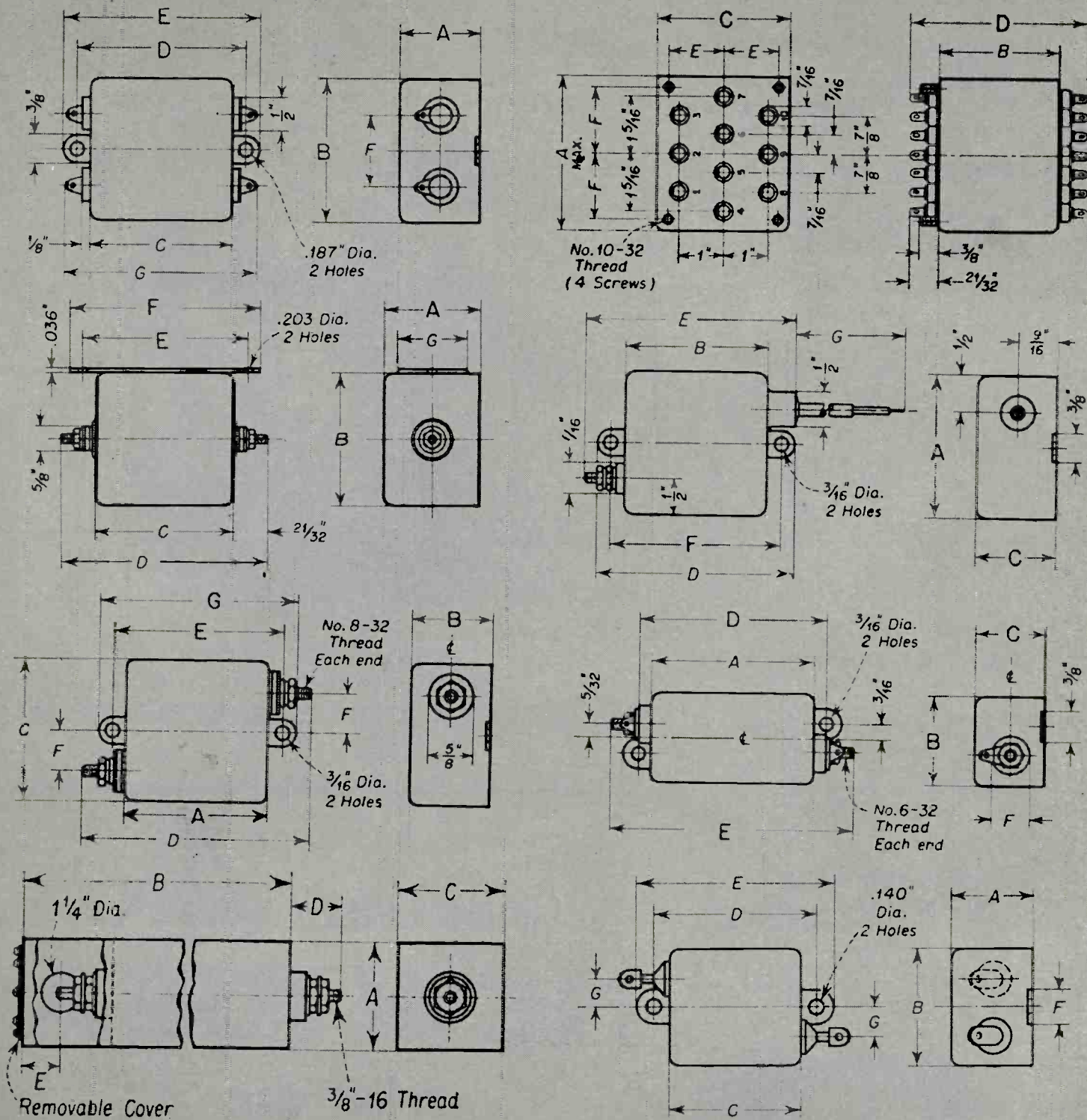

we make almost every type of interference filter you've

You probably know the range and diversity of filters that Cornell-Dubilier offers industry and government. Surely you know that CDE pioneered interference filters when many people didn't know what they were for! Yet do you know that CDE is now working on filters for high-temperature operations beyond the state of the art? Even now CDE is developing interference filters with a degree of reliability undreamed of a few years ago. In depth of experience and engineering personnel, CDE offers you unparalleled resources to design and produce the precise system you need for



CORNELL-DUBILIER
ELECTRONICS DIVISION
 FEDERAL PACIFIC ELECTRIC COMPANY

**SYSTEMS
 ENGINEERING
 SERVICES**

- Electromagnetic Compatibility Studies
- Systems Qualification
- Components Qualification
- RF Field Patterns and Area Surveys
- RF Interference Control
- RF Weapons Systems Management

ENGINEERING AND PRODUCTION SERVICES

RF Suppression Components

- PI Filters
- Feed-Through Capacitors
- L-C Filters
- L-Cap Feed-Through Capacitors
- Screen Room Filters

Filter Networks

- Audio Filters
- High- and Low-Pass Filters
- Band-Pass Filters
- Telemetry Filters
- Band Rejection Filters

ever seen... and thousands you've never seen before!

any interference problem. Today, as part of fast-growing Federal Pacific, CDE offers you more than ever in facilities, plants and people with an "urge to serve" that welcomes your inquiry for everything we make, for everything we can help you design. We have recently issued the above-illustrated brochure to describe the range and breadth of systems engineering services available to you whenever you consult with CDE. May we send you a complimentary copy? Cornell-Dubilier Electronics Division, Federal Pacific Electric Co., General Offices: 50 Paris Street, Newark 1, N. J.

CORNELL-DUBILIER ELECTRONICS DIV.



FEDERAL PACIFIC ELECTRIC COMPANY

growth through creative energy

Circle 109 on Inquiry Card

100 OPERATIONS PER SECOND! POSITIVE



New Adlake mercury wetted contact relays* deliver billions of trouble-free operations at speeds up to 100 operations per second. Ideal for applications as computing systems, signaling devices, tabulating machines and high speed switching. Thanks to mercury contact, they enjoy low, constant contact resistance, never become dirty or pitted, will not respond to the mechanical vibration of the metal armature. Will always provide positive closure. Contact rating is 250 volt—amperes, 500 volts maximum. 5 amperes maximum (with suitable contact protection.)

*Manufactured under license agreement with Western Electric Co., Inc.

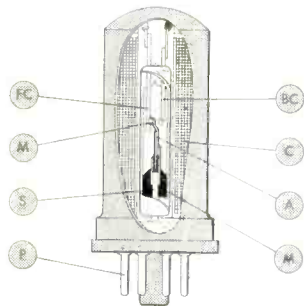

Platinum butterfly contact at top end of swinger or armature A rests against the normally closed contacts BC completing circuit. This electrical circuit is closed through mercury M adhering to platinum swinger contact point and also mercury adhering to platinum contacts at end of normally closed contacts BC. Circuit is further connected to proper pins P to complete circuit inside enclosure with external connections.

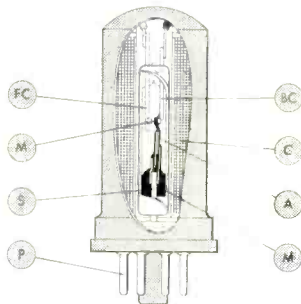

When coil C is energized, swinger moves from the normally closed contacts BC to the normally open contacts FC. This opens the normally closed circuit and closes the electrical circuit through the normally open contacts, FC through stem S, and through proper pins P to external circuit. Mercury M from pool at bottom of switch replenishes mercury dropped after each operation from contact points so circuit is always made and broken through two mercury surfaces.

New Products

MICROWAVE RADIO SYSTEM

New microwave system, Type UA-6B, accommodates up to 240 voice channels for point-to-point communication. Basically a duplex radio transmission set, the new equipment

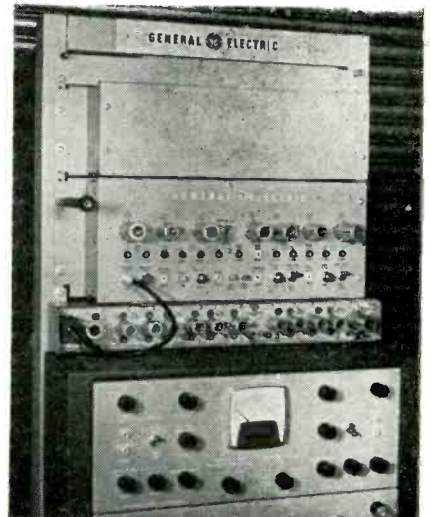

operates over the range of 5925-7450 MC. Integral "control" center test facilities permit metering of all critical voltages and currents, including r-f power monitoring and control of stations without removal of covers. General Electric Communication Products Dept., P.O. Box 4197, Lynchburg, Va.

Circle 274 on Inquiry Card

BEAM SWITCHING TUBES

The magnetically shielded BX-2000 and the high current BX-3000 are smaller, lighter and less expensive than their predecessors. The use of a 4-electrode structure in each of their 10 positions provides improved straight line switching and constant current output characteristics. The BX-3000 has a 5.5 ma constant cur-

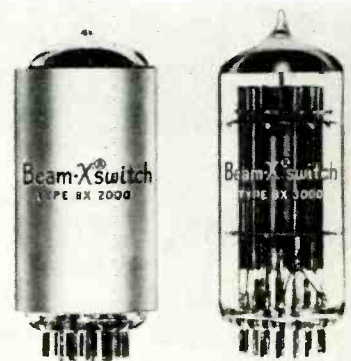

rent output. The BX-2000 provides 3 ma of constant current output. The 2 Beam-X switches have a 50,000 hr. life potential. Burroughs Corp., Electronic Tube Div., Box 1226, Plainfield, N. J.

Circle 275 on Inquiry Card

A⁺Adlake
mercury-wetted
relays

Mail Coupon For Adlake Bulletin MW

The Adams & Westlake Company, Dept. L-8802
Relay Division, Elkhart, Indiana

name _____
company _____
address _____
city & state _____

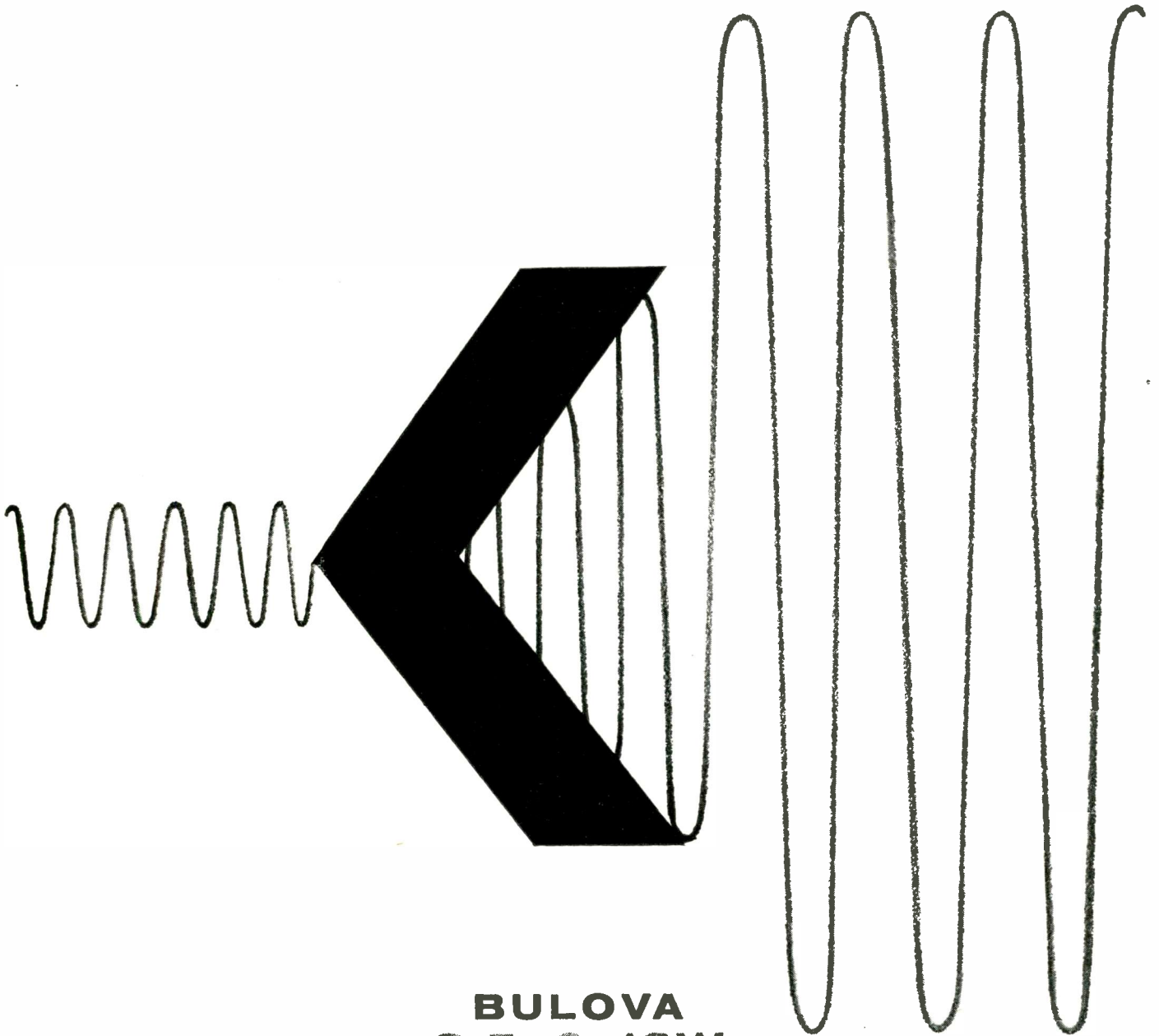

BULOVA 3.5, 6, 12W SERVO AMPLIFIERS



In addition to their "greater-than" conversions at high temperatures, the new Bulova Servo Amplifiers promise maximum flexibility in systems design with a minimum of ounces and inches.

The all-silicon transistors potted in these amplifiers assure continuous operation from $-50^{\circ}\text{C}.$ to $+125^{\circ}\text{C}.$ and provide maximum wattage output per unit volume and weight. Under varied and severe environmental and operating conditions, Bulova

Servo Amplifiers exhibit outstanding performance, portray the following characteristics: shock and vibration resistance, thermal and electrical stability.

If your requirement for a 3.5, 6 or 12w servo amplifier is a little more sophisticated, a bit more demanding than the average, take it to Bulova. There's a stock unit suited to your needs and budget. For additional data write Department 1671, Bulova Electronics, Woodside 77, New York.

AXIMAX MINIATURE 400CPS FANS

AXIMAX 1

12 to 23 CFM
11,400 to
22,500 RPM

1 13/32"
4 OZS.

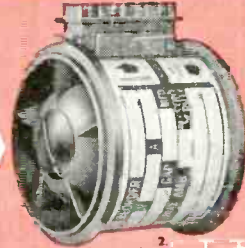

- Extremely compact and lightweight—1 1/2" x 1 3/4", 4 ozs.
- 115 or 200 VAC, 1 ϕ or 3 ϕ , 400 cps.
- Airflow reversible.
- Built to Military Specifications.

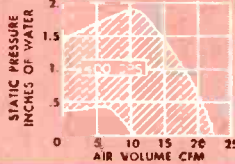

AXIMAX 2

24 to 60 CFM
8,000 to
20,000 RPM

1 15/32"
4 1/2 OZS.

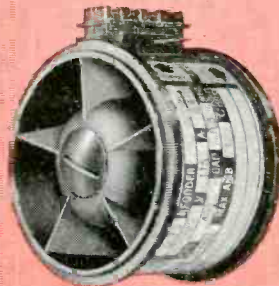

- Size: 2" x 1 1/2". Weight: 4 1/2 ozs.
- 115 or 200 VAC. 320 through 1600 cps. 1 ϕ or 3 ϕ
- High altitude (Altivar) \circledR and high density designs available.
- Airflow reversible.
- Built to Military Specifications.

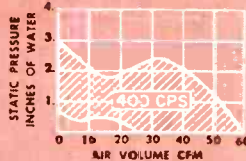

AXIMAX 3

70 to 165 CFM
9,000 to
22,000 RPM

2 3/4"
14 OZS.

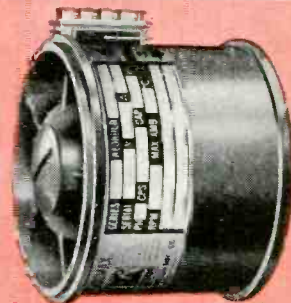

- Size: 3 1/4" x 2 3/4". Weight: 14 ozs.
- 115 or 200 VAC. 400 and other cps. 1 ϕ or 3 ϕ .
- High altitude (Altivar) \circledR and high density designs available.
- Airflow reversible.
- Built to Military Specifications.

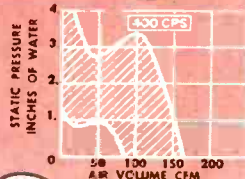

Appropriate cam-locking mounting clamps are available from Rotron for servo-mount Aximax fans.



Write for Complete
Technical Details,
or Submit Your
Cooling Problems for
Recommendations...



ROTRON
MANUFACTURING CO., INC.
WOODSTOCK, NEW YORK

New

Products

LOW FREQUENCY ANALYZER

This instrument analyzes the spectrum of signals from 0.0025 to 1000 CPS on a real time basis. Signals may be analyzed in 7 different scales. Selectivity on the lowest scale is 0.0037 cps. On the 1000 cps range,

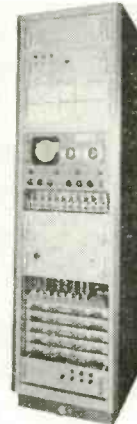

selectivity is 3.75 cps. The SA-11 system operates on the time scale change principle which causes multiplication of the frequency components of an input signal. Although the analyzer is restricted approx. 0 to 1000 cps, it is possible to extend this range by heterodyning to cover any band in 1000 cps increments. General Applied Science Labs., Inc., Merrick & Stewart Aves., Westbury, N. Y.

Circle 260 on Inquiry Card

ACCELEROMETER

General-purpose, piezoelectric accelerometer has a range of 0.05 to 10,000 G's. Operable in ambient temp. ranging from -100°F to +500°F, Model EM900 accurately measures shock up to 10,000 G's and vibration up to 10,000 cps with no measurable hysteresis observed. Sensitivity is 15 mv peak/G peak. Precision machining of its stainless-steel

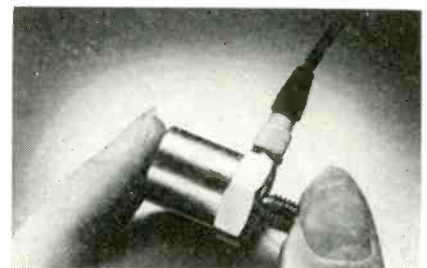

housing and shell, and of the seismic mass, provides linearity of $\pm 1\%$ and low transverse sensitivity of 3%. It weighs 35 grams. Raytheon Co., Industrial Components Div., 55 Chapel St., Newton 58, Mass.

Circle 261 on Inquiry Card

The Sylvania-developed circuit shown will provide a complete double-pulse sequence with trigger pulses in the order of 7 volts in amplitude and widths of 2 μ sec. It is useful where short random pulses are received or where continuous counting is desired without preliminary input stages. This circuit is primarily intended to operate low-speed counter tubes.

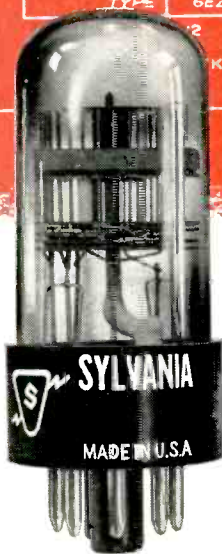
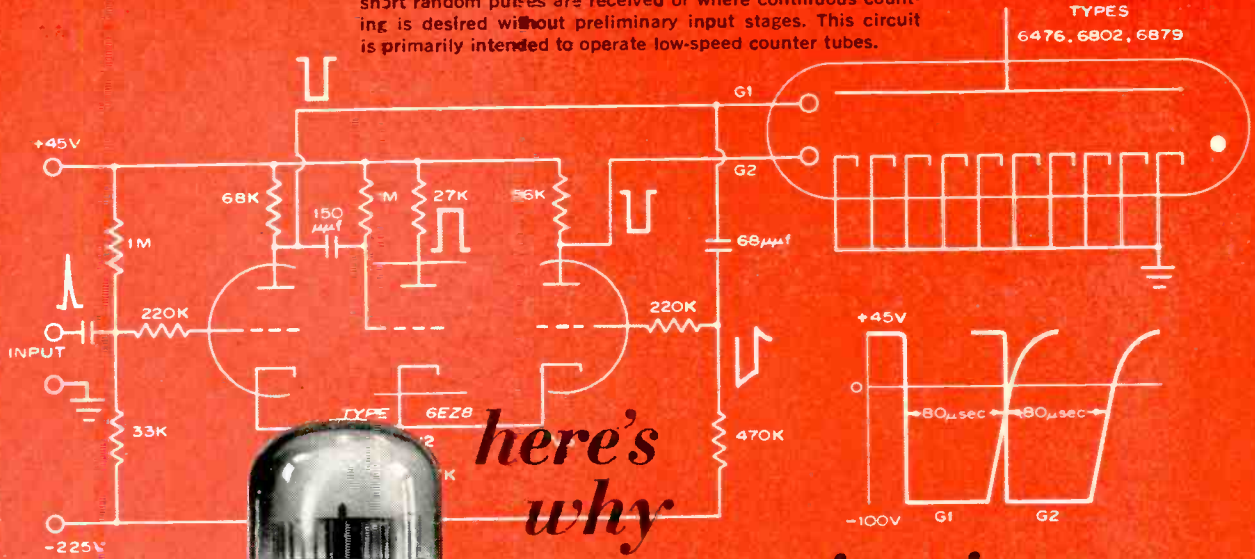

here's
why
your circuit
should specify
Sylvania
Counter
Tubes

Imagine a device so versatile it can *count . . . measure . . . monitor . . . program . . . sample . . . sort . . . index . . . scale . . . tabulate*. One that combines actuating and direct readout functions. And provides the following extraordinary results: significant circuit economies, compact equipment design and improved circuit reliability. The device? Sylvania Decade Counter Tubes!

Sylvania Cold Cathode Decade Counter Tubes provide visual readout from a sharply defined ion glow moving on a peripheral ring of 10 output cathodes around a common anode. They also feature add-subtract capabilities, low power requirements and low initial cost. *Sylvania Counter Tubes* offer high reliability even under long periods of standby operation — the result of improved design and rigid manufacturing control.

Measure the advantages of *Sylvania Decade Counter Tubes*. Count on your Sylvania Sales Engineer for full data and engineering assistance. For the informative Decade Counter Tube Handbook, contact your Sylvania Industrial Tube Distributor. Or, enclose 15¢ to Electronic Tubes Division, Sylvania Electric Products Inc., Dept. 192, 1100 Main St., Buffalo 9, N. Y.

Sylvania Types	Total Anode Current (mA) Min. Max.	Min. Anode Supply Voltage (Vdc)	Min. Double Pulse Amplitude (V)	Min. Double Pulse Width (μ sec)
0-4KC 6476 (T-11) 6802 (T-9) 6879 (T-5½)	0.3 0.6	350	-75	60
0-100KC 6909 (T-9) 6910 (T-11) 7155 (T-5½)	0.6 0.8	400	-85	4

SYLVANIA

Subsidiary of **GENERAL TELEPHONE & ELECTRONICS**



0.1 $\mu\mu\text{a}$ to 1 amp.

10⁻¹³ TO 1 CURRENT RATIO

1 μv to 1000 volts

10⁻⁹ TO 1 VOLTAGE RATIO



MODEL 95A
PRICE \$495

Sensitive DC Meter

- 0.1 $\mu\mu\text{a}$ to 1 amp. in 25 ranges
- 1 μv to 1000v in 17 ranges
- Simplicity of range switching
- 10 megohms constant input resistance on all voltage ranges
- Drift: $\pm 2 \mu\text{v/day}$ max.
- Fast response
- Floating input

Also Available Rack Mounted on a 5/4" x 19" Panel. Price \$520.

Boonton **ELECTRONICS** Corp.

Morris Plains, New Jersey • JEFFERSON 9-4210

New
Products

AVERAGE POWER METER

Microline Model 31A1 average power meter for laboratory, factory or field precision measurements of power, is accurate to 3% of full scale reading. It can be used to measure pulsed or cw power of radar, radio,



TV, microwave and microwave relay equipment components. Frequency coverage is limited only by the characteristics of the bolometer and mount used. It measures power levels up to 10 mw directly; this range can be extended as required by using directional couplers and/or calibrated attenuators. Further specs: Five ranges from 0-0.1 to 0-10 mw full scale and 2 ranges 0-10 and 0-15 db full scale. Power: 115 v., 50-60 cps. Recorder Output: 0-1 ma, 1500 ohms, one side ground. Weight: approx. 13 lbs. Sperry Microwave Electronics Co., P. O. Box 1828, Clearwater, Fla.
Circle 276 on Inquiry Card

GOVERNED DC MOTORS

This chronometrically governed dc motor has high accuracy and long life. Constant speed is independent of load, line and temp. variations. The 1.5 v. motor operates for more than 2 years on a flashlight battery. The governor's patented balance wheel-hair-spring mechanism has an accuracy of ± 10 sec. in 24 hrs. even with an input voltage range from 0.9 v. to

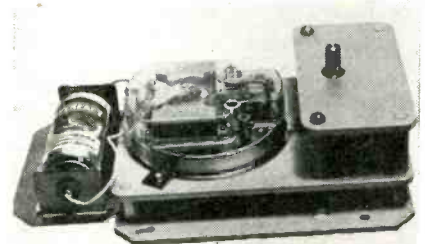

1.8 v. Measuring 1 3/4 x 2 1/2 x 1/2 in., the motor weighs 3 oz. Windings for 0.5 to 12 vdc can be supplied and a regulator hand for adjustment in the field is standard. A. W. Haydon Co., Waterbury, Conn.

Circle 277 on Inquiry Card

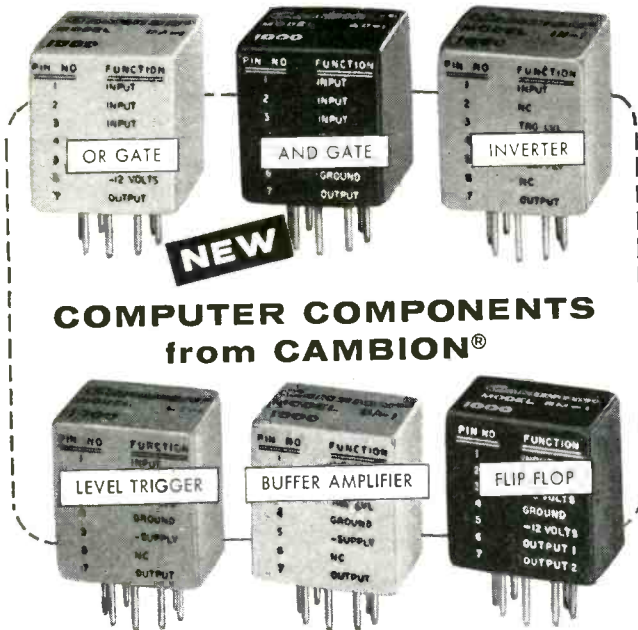

COMPUTER COMPONENTS
from **CAMBION®**

Here's the answer to the increasing need for performance tested, higher speed components. These color coded "building blocks," shown actual size, are conveniently packaged for ease of installation. All have superior frequency response — DC to 10 MC. Modules weigh only 9 grams, are .35 cubic inches in size. Write CAMBION Computer Components, 504 Concord Avenue, Cambridge 38, Massachusetts.

CAMBRIDGE THERMIONIC CORPORATION
CAMBION®
The guaranteed electronic components
Circle 115 on Inquiry Card

A NEW SERIES OF
KNOBS for TODAY'S
INSTRUMENTS



Especially designed to fill the multiple requirements on modern instrumentation. This new series (4 basic sizes plus a dual control) is shown in actual size. Write for FREE, complete catalog illustrating standard plastic parts available without tooling costs. Samples on request.

HARRY DAVIES
MOLDING COMPANY
1428 North Wells Street
CHICAGO 10, ILLINOIS

Circle 116 on Inquiry Card

NEW Methode
"FORK" CONTACTS

completely interchangeable with available types with **FULL RADIUSED CONTACTS** for smoother mating



IMMEDIATE DELIVERY!

Available in three different styles: for mounting upright printed circuit panel, parallel to printed circuit panel or for 45 angular mating. Fabricated from spring tempered phosphor bronze, finished with gold plating.

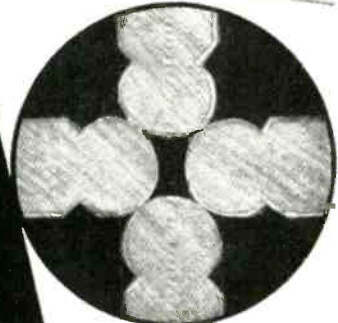

Microphotographic view of Methode Printed Circuit "FORK" CONTACTS

Available in bulk or on disposable plastic strips to users of specified dimensions for easy mounting.

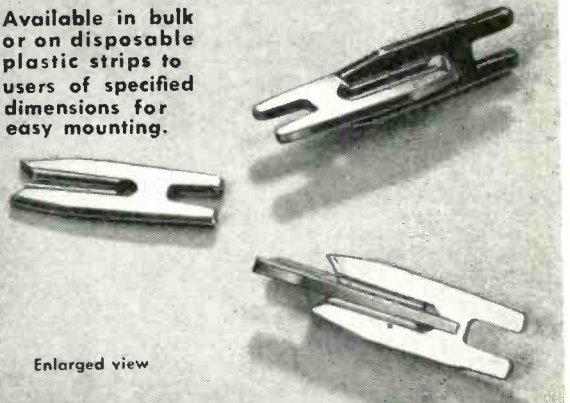

Enlarged view

Applications are limitless as determined by your design, ingenuity and needs. We invite your inquiry.

SAMPLES and detailed literature are available.



Methode
manufacturing corp.

7447 W. Wilson Ave. • Chicago 31, Ill.

Circle 117 on Inquiry Card

Special styles can be tooled upon request.

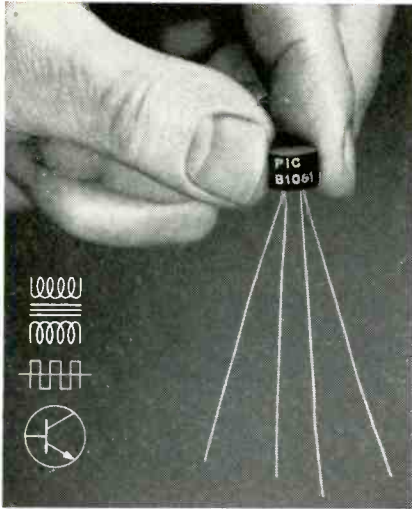

Get high density packaging with 0.023 in.³ PIC Transistor Pulse Transformers

Pulse transformers no longer need to remain the only over-size component in your high density transistor circuit packages.

Now you can get pulse widths from less than 1 to over 16 microseconds — plus the other parameters listed below — with transistor-size PICO TRAN[®] transformers.

Typical specs for 4:1 Turns Ratio PICO TRAN in a 12 V blocking oscillator circuit; and 1:1 Turns Ratio pulse coupling PICO TRAN:

4:1 Ratio	PW (μ Sec)	OCL (Pri)	1:1 Ratio	OCL (Pri)
B 350	1	65μH	B 355	65μH
B 351	2	150μH	B 356	150μH
B 352	4	450μH	B 357	450μH
B 353	8	1.25mH	B 358	1.25mH
B 354	16	5.0 mH	B 359	5.0 mH

Dimensions all units: 11/32" dia. x 1/4" high

PICO TRAN P10B pulse transformer kits containing one each of types B350 thru B354 are available from stock at \$59.95.

This breakthrough in transformer miniaturization came from PIC's 13 years of experience in the manufacture of magnetic components. The PICO TRAN is a thoroughly tested production unit. Its reliability has been proven.

For complete PICO TRAN specifications and applications assistance, contact your nearest PIC Rep, or write to PIC on your company letterhead. You can see the PICO TRAN at the IRE Show—PIC is in booth No. 2839.

POLYPHASE



Instrument Company
Bridgeport, Penna.

PULSE TRANSFORMERS • FILTERS • DELAY LINES
MAGNETIC AMPLIFIERS • SPECIALTY TRANSFORMERS • NETWORKS
MINIATURIZED MAGNETIC COMPONENTS • TOROIDAL COMPONENTS

Circle 118 on Inquiry Card

New Products

TRIMMING POTENTIOMETERS

Two types of subminiature precision trimming potentiometers are for printed circuit and high stability applications. Type CT-100 (pictured) features an electrical and mechanical tap adjust rotation of $320^\circ \pm 5^\circ$. Type CT-200 is a $\frac{1}{2} \times \frac{1}{2}$ in. sq. precision trimmer for stability under high moisture conditions. Standard range

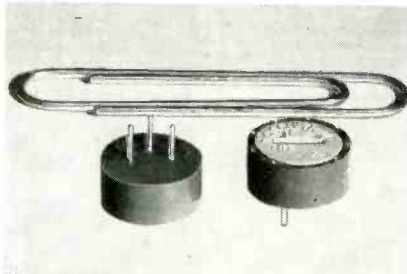

of both units is 10 ohms to 50K ohms, tolerance is $\pm 5\%$, and the power rating is 1.0 w. at 60°C . Operating temp. range is -55°C to 150°C or 225°C . International Resistance Co., 401 N. Broad St., Phila. 8, Pa.

Circle 267 on Inquiry Card

CONTROLLED RECTIFIERS

C50 high current silicon controlled rectifiers are for use in power controls and power switching. The 8 models differ by repetitive peak reverse voltage ratings from 25 v. for the C50U to 400 v. for C50D. The

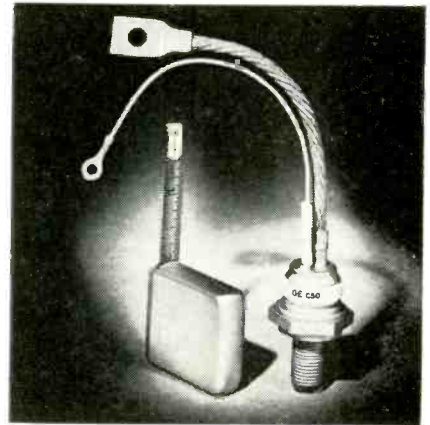

average forward current of these SCR devices is up to 70 a. max. ac rating and 110 a. max. dc rating. The typical gate current required to fire these units is 15 ma at 1.5 v., while the max. gate voltage to fire is 3.0 v. Typical turn-on time is 1.0 to 4.5 μsec while the typical turn-off time is 15 to 25 μsec. General Electric Co., Kelley Bldg., Liverpool, N. Y.

Circle 266 on Inquiry Card



"You Rubbed, Sir?"

Reeves-Hoffman transistorized, proportionally controlled ovens do give almost miraculous service—in providing closer frequency control. These highly reliable ovens have no mechanical contacts. There are no spark-producing gaps. Radio interference is eliminated. Although it is difficult to measure temperature excursions beyond $\pm 0.1^\circ\text{C}$, it is reliably estimated that Reeves-Hoffman ovens provide control in the order of $\pm 0.001^\circ\text{C}$. If you have a problem involving reliable temperature control, contact Reeves-Hoffman for additional information.

WRITE FOR BULLETIN V1090.

DIVISION OF

DYNAMICS CORPORATION OF AMERICA
CARLISLE, PENNSYLVANIA

Circle 119 on Inquiry Card



0/100



The newest Mincom magnetic tape instrumentation recorder / reproducer, to be announced in detail next month, answers the need for better performance in the intermediate frequencies. Covering bandwidths from 200 cps to 300 kc at 60 ips with improved dynamic range, it fills the gap between Mincom's Model C-100 (125 kc-60 ips) and the Model CM-100 (1 mc-120 ips). The new model also is extremely versatile, offering both FM and Direct recording / reproducing. One-rack compactness, all-transistorized electronics. Wait and see more of this new system's extra capabilities.



... WHERE RESEARCH IS THE KEY TO TOMORROW

MINCOM DIVISION **MINNESOTA MINING AND MANUFACTURING COMPANY**

2049 SOUTH BARRINGTON AVENUE, LOS ANGELES 25, CALIFORNIA • 425 13TH STREET, N.W., WASHINGTON 4, D.C.



Davey-Paxman Vertical Boiler • Davey-Paxman & Co. • Circa 1876

Old Fashioned?

See what **Ungar** does to soldering tools next month!

Circle 121 on Inquiry Card

For that  **NEW IDEA**
visit the
IRE SHOW

March 20-23, 1961 New York
Coliseum and Waldorf-Astoria Hotel

Members \$1.00, Non-members \$3.00 Age limit—over 18

Circle 122 on Inquiry Card

New Products

MICROWAVE POWER SUPPLY

A new 10 kv. regulated microwave tube power supply is available. The output voltage is 0 to 10 kv., current range is 0 to 100 ma. Ripple content 0.4% max. Adjustable overload relay provides protection. Overload current

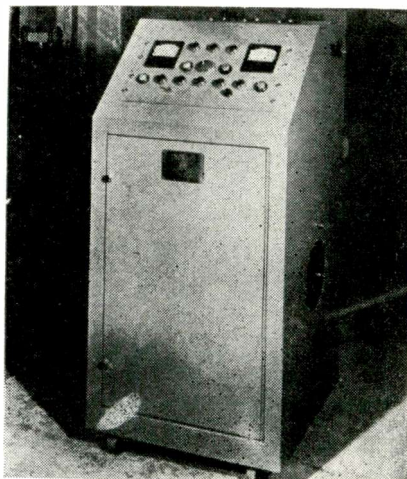

is manually set from 25 ma to 100 ma. Ground polarity is selectable by a front panel control. All controls and indicators are arranged for self-explanatory on/off control procedure, and an oversized "panic" button offers a quick shut off in an emergency. Model Z851-2 operates from 208 vac, 3 ϕ , 60 cps. FXR, Inc., 25-26 50th St., Woodside 77, N. Y.

Circle 262 on Inquiry Card

WAVEGUIDE SWITCHES

Waveguide shorting switches are hand operated, plunger type, on/off switches, providing a removable short in transmission systems. Eight separate switches were designed to operate over the freq. range of 2.6 to 40 KMC with the following characteristics: VSWR in the open position is 1.02 max.; VSWR in the short position

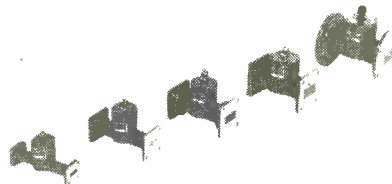

is 125 min. Insertion loss is negligible in the open position. In operation, plunger is introduced into the waveguide section sealing off the transmission system. Waveline Inc., Caldwell, N. J.

Circle 263 on Inquiry Card

NEW solder development!

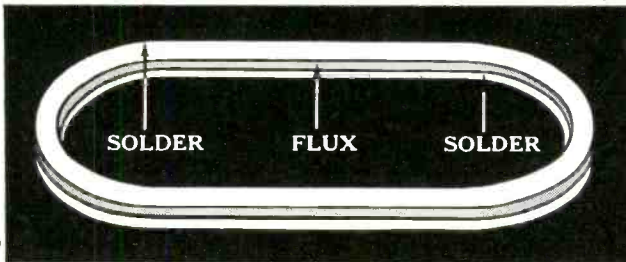

ALPHA flux-filled washers open a whole new field of automatic soldering opportunities!

Unique design insures maximum surface-to-surface contact on close-fitting parts, complete peripheral fluxing. Produced through a special ALPHA process, they provide, for the first time, completely new soldering opportunities.

ALPHA makes a wide range of flux-filled and solid preforms. Request information today!

When dependability counts!

alpha metals INC. 

In Los Angeles, Calif.:
2343 Saybrook Ave.

In Chicago, Ill.:
ALPHALOY Corp., 2250 S. Lumber St.

58J Water St.,
Jersey City 4, N. J.

Other ALPHA products:

Core and Solid Wire Solders • Fluxes • High Purity Metals

Circle 123 on Inquiry Card

Where can you use VARFLO?

(the highly flexible Class B Sleeving and Tubing that licks Class A in performance—equals it in price)

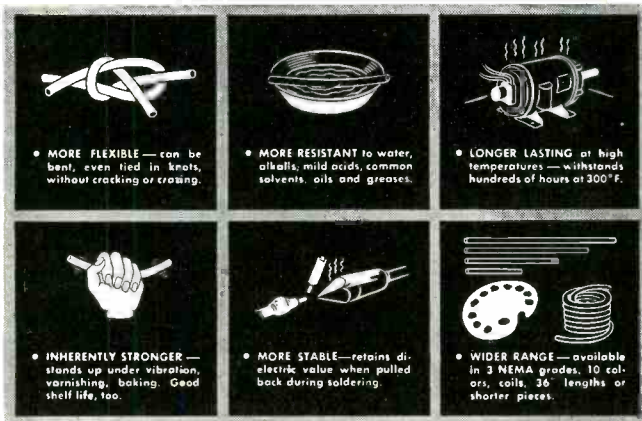

Cuts inventory, too! Superior to Class A insulation in performance—yet on a par with it in price—Varflex Sleeving and Tubing can be used economically for all Class A and Class B installations. This low-cost adaptability of Varflex enables many of our customers to achieve substantial savings in inventory. Available in NEMA Grades A-1 and B-1 tubing and Grade C-2 sleeving.

Perhaps Varflex can solve your insulating problems. Describe them in a letter—no cost or obligation for our recommendations. Samples available.

Approved for application under MIL-I-21557

506 W. Court St., Rome, N. Y.



Circle 124 on Inquiry Card

Only



has it!

... a machine which now makes possible the rapid, automatic continuous organic finishing of electrical and electronic components having coaxial leads.

THE NEW IMPROVED MODEL HD-3 REMOTE MASKING SPRAY COATER

The first completely automatic machine for accurate coating of diodes and other small components of varying lengths with sprayable materials at a rate of up to 10,000 per hour, depending on the coating requirements and size of the components. Applies a protective coating or light, tight seal for diodes.

Automation is practical, inasmuch as the coating material is confined by remote masking, **ELIMINATING THE NEED OF SPRAY MASKS, REGISTERING DEVICES AND MASK CLEANING OPERATIONS.** The machine can be adapted to fit individual requirements.

40 loaded trays of axial lead components, after painting, are stacked in a portable magazine.



Conforming Matrix

CORPORATION

839 New York Avenue
Toledo 11, Ohio
Phone RA. 9-3777

Circle 125 on Inquiry Card

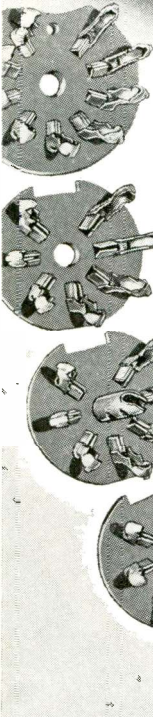
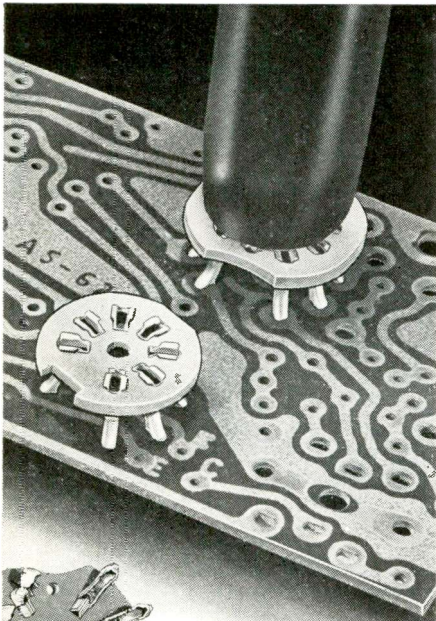

NEW!

**single wafer
tube sockets
for printed
circuit
boards!**

- 25% reduction in cost of sockets.
- Single wafer eliminates moisture traps.
- Higher Voltage Breakage between adjacent contacts.
- Available with center shield and tube shield ground strap. 7 pin and 9 pin.
- Locks into chassis and will not loosen during handling and vibration.
- Contacts have excellent tube retention qualities—no "bridges".



**UNITED
INTERNATIONAL
DYNAMICS
CORPORATION**

373 Long Beach Road • Oceanside, L. I., N. Y.
Manufacturer of Slide Switches

Pat. Pending

Circle 126 on Inquiry Card

New Products

WATERTIGHT LIGHT

The L16,200 indicator light is available with 6, 14 or 28 v. lamp. Unit features front of panel lamp replacement, anodized aluminum case and a selection of 7 lens colors. It comes with grey silicone rubber boot with panel sealing rib thus providing wa-

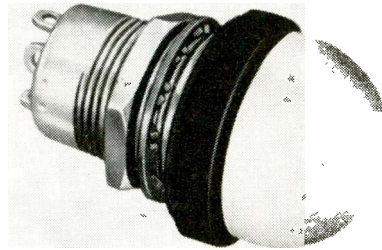

tertight lens and performance reliability. This indicator light was designed for military and aircraft applications. Control Switch Co., Div. Controls Co. of America, Folcroft, Pa.

Circle 271 on Inquiry Card

GENERAL PURPOSE RELAY

The GH Series relay line has been improved to assure a longer, trouble-free operating life. A riveted crossbar replaces the screwed down type, a linen-based phenolic insulator is now used between the crossbar and

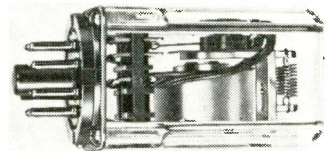
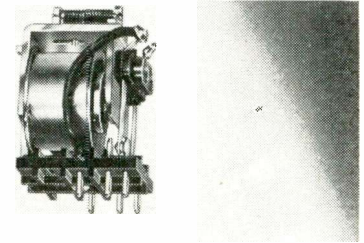

armature. Wires used are 20 ga. rope-lay type to resist wire breakage. The GHA (5 a.) and GHB (10 a.) open series carry UL approval. The same range of coil voltages, mounting and contact arrangements in both open and dustite enclosures are still available. Elgin Advance Relays, Electronics Div., Elgin National Watch Co., 2435 N. Naomi St., Burbank, Calif.

Circle 270 on Inquiry Card

**NEW...TYMETER
DIGITAL CLOCK
12 and 24 HOUR READ OUT**

- Front Panel Mount • Desk or Bench Use
- Digits Resetttable Individually

Also available in:

- ELAPSED TIMERS • IMPULSE TIMERS
- COUNT DOWN TIMERS

Height 4 1/2", Width 6", Depth 3/4"

Write for Catalog and Complete Line Showing Specifications

PENNWOOD NUMECHRON CO.
7249 FRANKSTOWN AVE. PITTSBURGH 8, PA.

Circle 127 on Inquiry Card

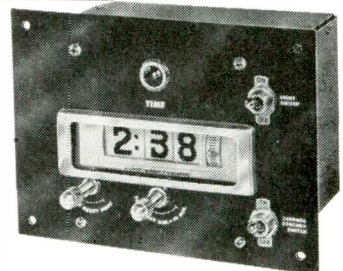

AIR-TIGHT, WATER-TIGHT BLIND FASTENER



"WELL-NUTS" isolate vibration • space and fasten simultaneously • accept conventional threaded fasteners • will not crack or mar porcelain or glass. Send for literature and samples.

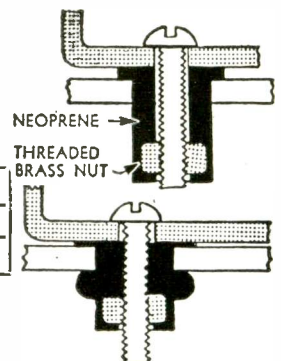

*Patented

		STANDARD SIZES						
Catalog Number	6S	10S	G-1032	10SL	1/4S	0-1420	Z3816	
Standard Thread	6-32	10-32	10-32	10-32	1/4-20	1/4-20	3/8-16	
Length	7/16"	3/64"	5/8"	1"	37/64"	41/64"	45/64"	

ROCKWELL PRODUCTS CORPORATION

146 Central Ave., Dept. A, Newark 3, N. J., Market 3-7650

Circle 128 on Inquiry Card

**SNAP-IN . . . SNAP-OUT CONTACTS
NO INSERTION TOOLS REQUIRED**

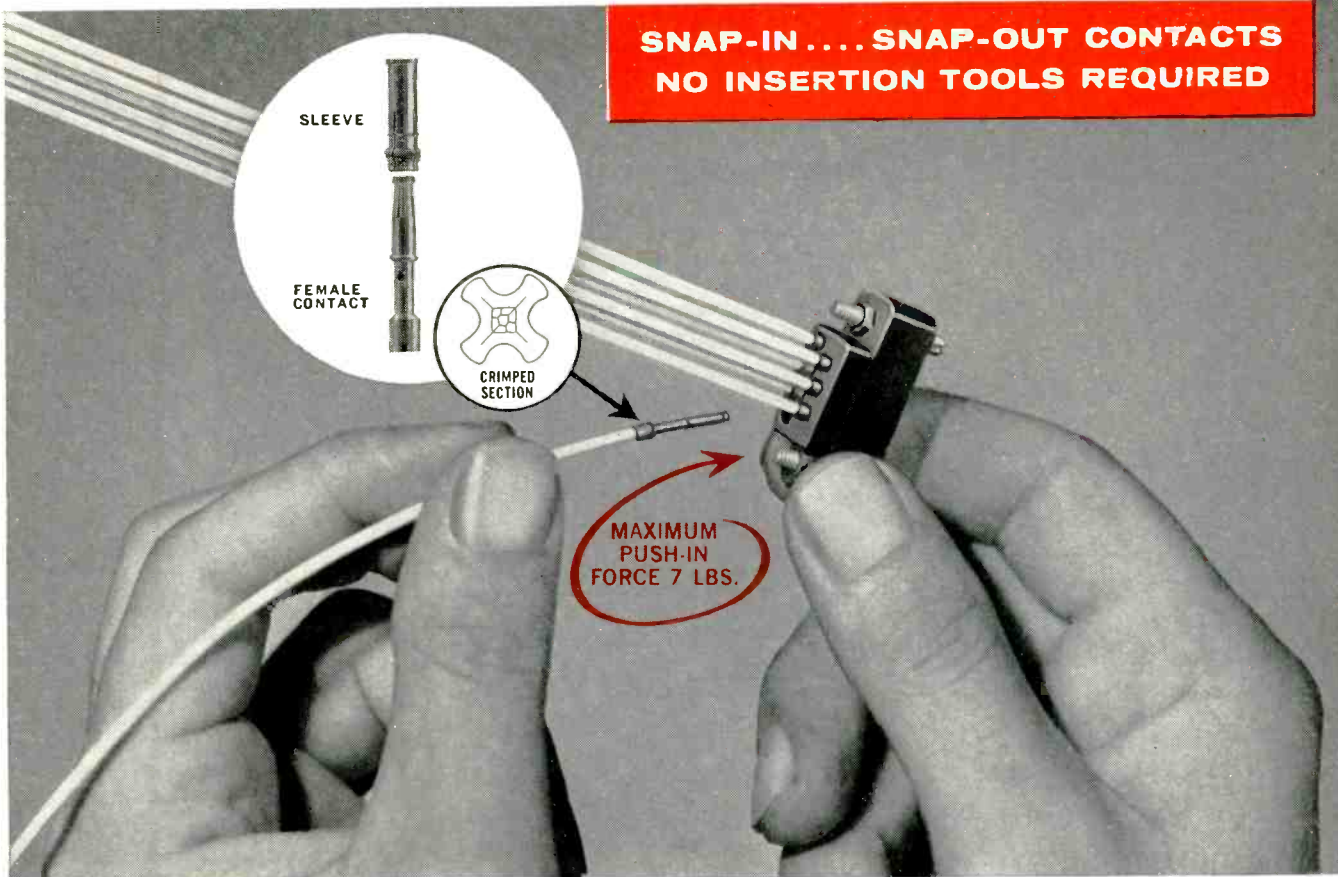

REMI®

re-entrancy miniature

REMI means the best in . . . **RE**movability, **RE**liability, **RE**entrancy

- Sleeve, which is part of connector block, allows for interchangeability of male and female contacts on the same connector, at will.
- Additional polarization and keying can be accomplished by use of dummy pins.
- Contacts can be inserted with finger pressure of 7 lbs. max. — yet they withstand an initial pull of at least 20 lbs. Contact removal is accomplished easily by use of REMI spring-loaded tool or by a simple improvised tool.
- Conforms to all applicable functional provisions of MIL-C-26636.
- Mechanical stresses are confined between metallic elements rather than between metal and plastic insulation.
- Terminals are designed to crimp wire sizes from #18 A.W.G. to #26 A.W.G. with REMI hand-operated crimping tool meeting MIL-T-22520 (WEP) or REMI pneumatic or semi-automatic crimping tools. Terminals can also be provided with solder cup, turret, or eyelet design.
- All REMI design features combine to offer the ultimate in reliability under extreme environmental conditions.

Available in 7, 12 (8-4), 14, 18, 20, 21, 26, 34, 41, 42, 50, 75, 123, 150, 225 Contacts

U.S. COMPONENTS, INC.

1320 Zerega Ave., New York 62, N. Y. TAlmadge 4-1600

Patents applied for



REMI-SL



REMI-BSL

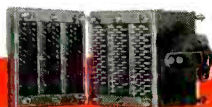

REMI-BMSL

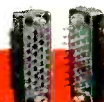

REMI

very
big
in
BWOs

Eight years ago, the first commercial backward wave oscillator took shape in the patient hands of wave tube pioneer Ray Stewart. With meticulous care and consummate skill, he evolved a precision lens system for forming a hollow electron beam, and developed techniques for producing a fantastically accurate helix pitch and placement relative to the beam.

The result was an oscillator of truly exceptional characteristics. But because Ray Stewart will never be satisfied with the merely exceptional, each BWO he builds . . . and he has built thousands . . . is better than the one before it.

This is the reason why Ray's BWOs can be guaranteed for 500 hours, and why they consistently outlive their guarantees. Ray's company is the only electron tube manufacturer devoted exclusively to the production of backward wave oscillators. The tube shown here is one of a series covering the frequency range 1-18 kmc.

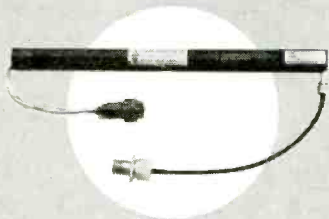

Write for the new Stewart Engineering brochure and a set of specification sheets. When you've found out about the low operating costs of Stewart BWOs, we promise you'll be very big with your company's treasurer.

**STEWART
ENGINEERING
CORPORATION**



SANTA CRUZ • CALIF.

Circle 130 on Inquiry Card

New Products

OFFICE MACHINE MOTOR

The 26 Frame series of 3 in. induction motors are for office machines and similar uses. They are designed with 24 slot stators instead of the conventional 16, thus achieving smoother more constant torque and

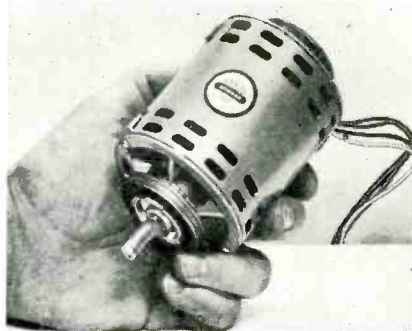

quietness. Two types of bearings are available, porous bronze or ball bearings. Non-porous Mylar plastic insulation is used. Three types of mountings are available. The 4-pole ratings are available up to 1/20 hp, the 2-pole units are made in ratings up to 1/10 hp. The 3 in. dia. is constant, the length varies from 3 11/16 to 5 7/16 in. Howard Industries, Inc., Dept. 31, Racine, Wis.

Circle 264 on Inquiry Card

MOTORS

A 4500 frame series ac motors are available with 1, 2 or 3-phase inputs, 26 v. to 230 v. Frequencies range from 25 to 400 CPS. Outside dia. is 5 3/8 in. The series includes units which provide outputs to 1.5 hp as induction motors, up to 300 in.-oz. stall torque as torque motors and from 1/200 to 1/4 hp as hysteresis

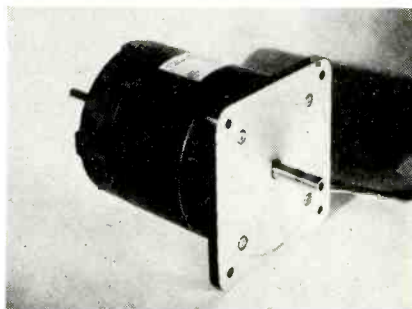

synchronous motors, which can also be wound for 1, 2, 3 and 4 speed operation. Units operating up to 150°C are also available. IMC Magnetics Corp., Eastern Div., 570 Main St., L. I., N. Y.

Circle 265 on Inquiry Card

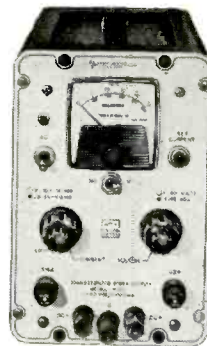

MODEL
4005
with



**CONSTANT VOLTAGE
CONSTANT CURRENT**
with
**PROGRAMMABLE
CROSSOVER**

\$143⁵⁰

F.O.B.
FACTORY

Other Models
Available
Write For
Catalog

*TM

Model 4005 is a 1-40 volt, 500 ma, regulated DC power supply incorporating AMBITROL.* The AMBITROL* circuit will switch automatically to either voltage regulation or current regulation at any point predetermined by the operator, with continuous control of voltage or current to .05%.

Power Designs inc.

1700 SHAMES DRIVE
WESTBURY, NEW YORK
Edgewood 3-6200 (LD Area Code 516)

Circle 131 on Inquiry Card

**MINIATURIZED!
LIGHTWEIGHT!**

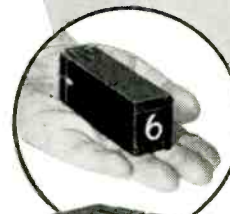

**ONE LINE
DIGITAL
READOUT**
Series 120000

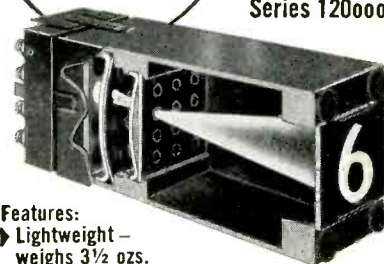

Features:

- ▶ Lightweight — weighs 3 1/2 ozs.
- ▶ Quick disconnect at rear for easy lamp replacement.

PRICE COMPLETE
\$35⁰⁰

Quantity Prices On Request

WRITE TODAY FOR
COMPLETE SPECIFICATIONS
Representatives
in principal cities

INDUSTRIAL ELECTRONIC ENGINEERS, Inc.
5528 VINELAND AVENUE
NORTH HOLLYWOOD, CALIF.

Over 1000 firms
throughout the
world in just a
few years prove
unprecedented
acceptance of
IEE digital
readouts.



Circle 132 on Inquiry Card

New Products

COMMUNICATION ANTENNAS

The 30-50 mc fixed station antenna is available for communications. Type 902, Helipole employs a bifilar helical element in the fibreglas encased radiator. The ground rods use single

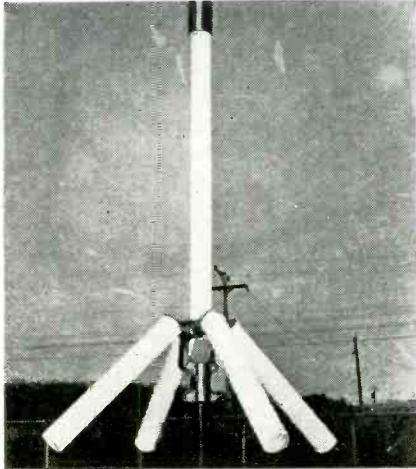

helix conductors. Lightweight (13 lbs.) and durable (30 psf with 1/2 in. ice), the antenna effects a size reduction over conventional types. Andrew Corp., P. O. Box 807, Chicago 42, Ill.

Circle 268 on Inquiry Card

MERCURY-WETTED RELAYS

These mercury-wetted relays mount on printed circuit boards in a similar manner to resistors. The switch capsule is potted in a plated steel enclosure providing mechanical protection and magnetic shielding. The

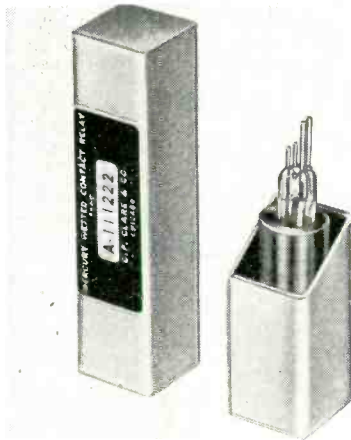

modules are available with standard HG switch capsules or the sensitive and fast HGS capsules. Coils are wound to customer's specifications. C. P. Clare & Co., 3101 Pratt Blvd., Chicago 45, Ill.

Circle 269 on Inquiry Card

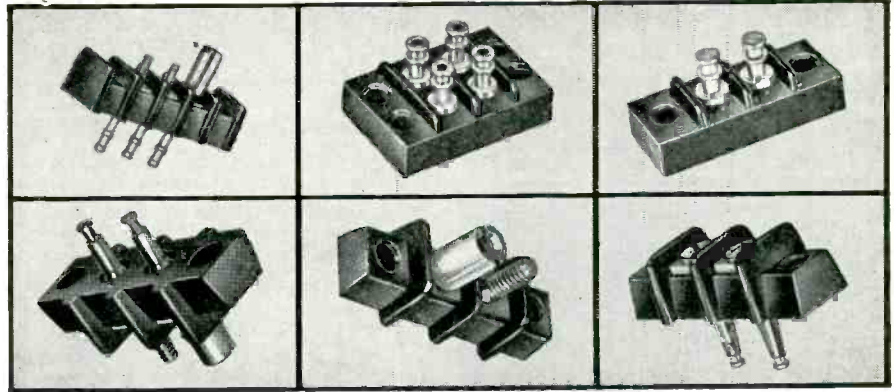

STUD AND TURRET TERMINAL BLOCKS

FOR WIRING CONVENIENCE

For faster, better, and more appropriate terminations, Kulka offers all their popular terminal blocks with your choice of terminal. Now you can choose from regular screw-type, solder-turret, feed-through, threaded stud, or any combination of terminals to best suit your specific requirements. And, you can call your own choice of finishes — electro-tinned, silver-plated, or even gold-plated over silver. Kulka maintains complete design and consultation services to aid customers in the proper terminal selection. Send us your requirements, or...

WRITE FOR COMPLETE DETAILS

KULKA ELECTRIC CORP.

633-643 SO. FULTON AVENUE, MOUNT VERNON, N. Y.
Circle 133 on Inquiry Card

SPECIAL

WELDING TIPS, HOLDERS and WELDING JIGS

MADE TO YOUR SPECIFICATIONS

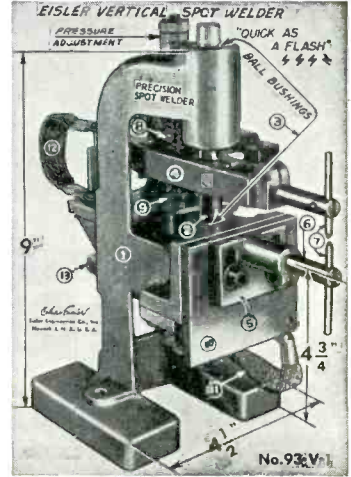
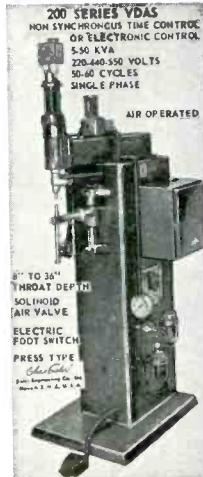
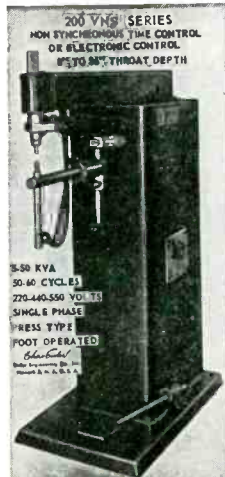
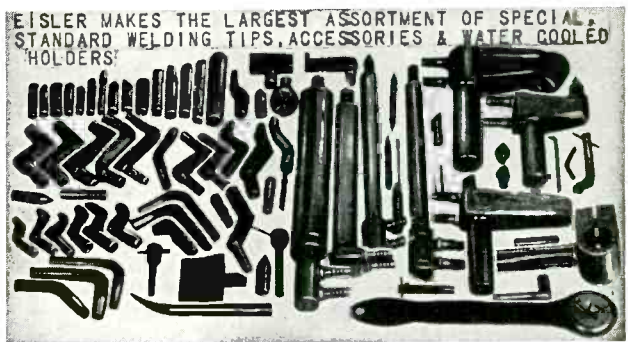

EISLER ENGINEERING CO., INC. 770 So. 13th St., NEWARK 3, N. J.

Write For Catalog W-61

SPECIAL TOOLS FOR SPECIAL PROBLEMS

Odd as they look, these are actual production tools. They were manufactured by Xcelite to increase efficiency on special assembly work where conventional hand tools proved inadequate.

Chances are that "special function" tools can speed your production. Supply prints (model if available) of part on which tool will be used. Prototype designed and tooled for your approval. Any quantity . . . to meet your production schedule. Contact factory direct.

Complete information in new "Custom-made Tool" Brochure No. 660. Request on your letterhead.

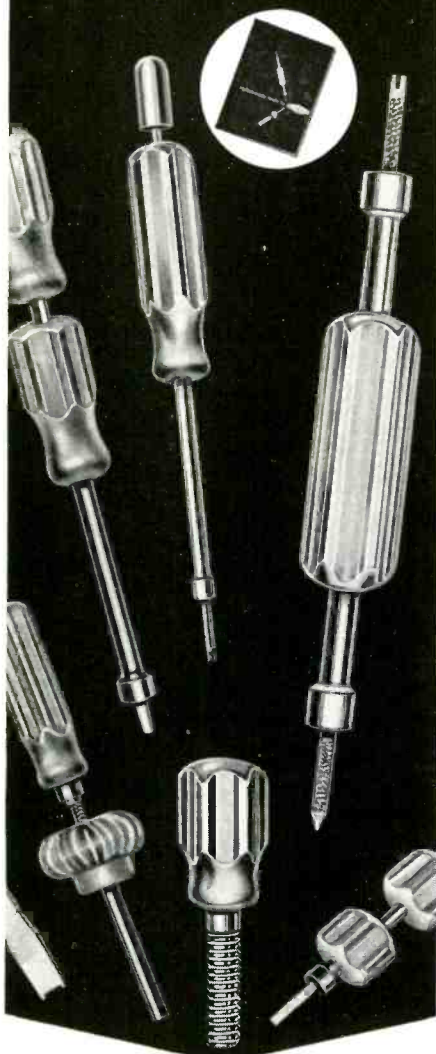

XCELITE

INDUSTRIAL HAND TOOLS

XCELITE, INC. • ORCHARD PARK, N. Y.
Circle 135 on Inquiry Card

New Products

FREQUENCY-SHIFT CONVERTER

New frequency-shift converter the 700B-1, provides a single channel of half-duplex teletype communications at speeds up to 100 words-per-minute via any single sideband or AM radio circuit. It can also be used in air-



borne data systems for transmitting digital information at up to 75 bits-per-second. It will accommodate a doppler shift for speeds up to 600 knots. In fixed station operation, the teletypewriter may be located as far as 1 mi. from the converter. It is all-solid-state, compact, and fits into a standard 1/4 ATR rack and weighs 12 lbs. Features include electronic keyer and built-in loop-current power supply. It is compatible with any frequency or frequency shift necessary for special applications. Collins Radio Co., Western Div., 2700 W. Olive Ave., Burbank, Calif.

Circle 272 on Inquiry Card

JUNCTION BLOCK

A junction block for tapping runs of subminiature coaxial cable, the ConheX, features crimp-on cable connections whereby assembly time is reduced approx. 60%. It maintains optimum electrical characteristics in both main cable run and tap cable run. In the form of a "T," the junction block has a slotted center coupler to receive the center conductor of the main run cable. The main run cable is cut, dressed, and the center conductor is soldered into the contact

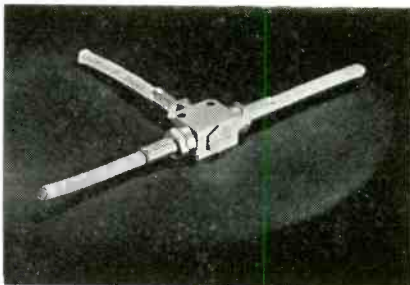

slot. The tap is made by the usual type of connection through the vertical leg of the "T." Tap connection mates with standard ConHeX connector. Sealectro Corp., 610 Fayette Ave., Mamaroneck, N. Y.

Circle 273 on Inquiry Card

IMMEDIATE DELIVERY OF ELMENCO

capacitors

IN QUANTITIES UP TO
500 Per Item

CONTACT THESE AUTHORIZED
ELMENCO INDUSTRIAL DISTRIBUTORS

ARIZONA: Radio Specialties & Appl. Corp., 917 N. 7th St., Phoenix.

CALIFORNIA: Brill Elect., 610 E. 10th St., Oakland; Elect. Supply Corp., 2085 E. Foothill Blvd., Pasadena; Federated Purchaser Inc., 11275 W. Olympic Blvd., L. A. 64; Hollywood Radio Supply Inc., 5606 Hollywood Blvd., Hollywood 28; Newark Electronics Corp., 4747 W. Century Blvd., Inglewood; Pacific Wholesale Co., 1850 Mission St., San Francisco 3; Peninsula Elect., 656 S. 1st St., San Jose; Shanks & Wright Inc., 2045 Kettner Blvd., San Diego; Shelley Radio Co. Inc., 2008 Westwood Blvd., L. A. 25; R. V. Weatherford Co., 6921 San Fernando Rd., Glendale 1; Zack Electronics, 654 High St., Palo Alto.

COLORADO: Denver Electronics Supply Co., 1254 Arapahoe St., Denver 4.

DISTRICT OF COLUMBIA: Capitol Radio Wholesalers Inc., 2120 14 St., N.W., Wash., D. C.

FLORIDA: Elect. Supply, 1301 Hibiscus Blvd., Melbourne; Elect. Supply, 61 N. E. 9th St., Miami.

ILLINOIS: Newark Electronics Corp., 223 W. Madison St., Chicago 6.

MARYLAND: D & H Distributing Company, Inc., 2025 Worcester St., Baltimore 30; Kann-Eilert Electronics, Inc., 2050 Rock Rose Avenue, Baltimore; Wholesale Radio Parts Co. Inc., 308 W. Redwood St., Baltimore 1.

MASSACHUSETTS: Cramer Electronics Inc., 811 Boylston St., Boston 16; Radio Shack Corp., 730 Commonwealth Ave., Boston 17.

NEW JERSEY: Federated Purchaser Inc., 1021 U.S. Rte. 22, Mountainside; General Radio Supply Co., 600 Penn St., Camden 2; Radio Elec. Service Co., Inc., 513 Cooper St., Camden 2.

NEW MEXICO: Electronics Parts Co., Inc., 222 Truman St., N. E., Albuquerque; Midland Specialty Co., 1712 Lomas Bl. N. E., Albuquerque; Radio Specialties Co., Inc., 209 Penn Ave., Alamogordo.

NEW YORK: Arrow Elect. Inc., 525 Jericho Turnpike, Mineola, L. I.; Elect. Center Inc., 211 W. 19th St., N. Y. 11; Harvey Radio Co., Inc., 103 W. 43rd St., N. Y. 36; Lafayette Radio, 100 Sixth Ave., N. Y. 13; Stack Industrial Electronics, Inc., 45 Washington Street, Binghamton; Terminal Elect. Inc., 236 W. 17 St., N. Y. 17.

NORTH CAROLINA: Dalton-Hege Radio Supply Co., Inc., 938 Burke St., Winston-Salem.

PENNSYLVANIA: Almo Radio Co., 913 Arch St., Philadelphia; George D. Barbey Co. Inc., 622 Columbia Ave., Lancaster; George D. Barbey Co. Inc., 2nd & Penn Sts., Reading; O. & H. Distributing Co., Inc., 2535 N. 7th St., Harrisburg; Phila. Elect. Inc., 1225 Vine St., Phila. 7; Radio Elec. Service Co., Inc., 701 Arch St., Phila. 6; A. Steinberg & Co., 2520 N. Broad St., Phila.; Wholesale Radio Parts Co., Inc., 1650 Whiteford Rd., York.

TENNESSEE: Electra Distributing Co., 1914 West End Ave., Nashville 4.

TEXAS: All-State Dist. Co., 2411 Ross Ave., Dallas 1; Busacker Elect. Equip. Co. Inc., 1216 W. Clay, Houston 19; Engineering Supply Co., 6000 Denton Dr., Dallas 35; Midland Specialty Co., 500 W. Paisano Dr., El Paso; The Perry Shankle Co., 1801 S. Flores St., San Antonio.

UTAH: Carter Supply Co., 3214 Washington Blvd., Ogden.

WASHINGTON: C & G Radio Supply Co., 2221 Third Ave., Seattle.

CANADA: Electro Sonic Supply Co., Ltd., 543 Yonge Street, Toronto 5, Ont.

ARCO ELECTRONICS, INC.
NEW YORK • DALLAS • LOS ANGELES
Exclusive Supplier of ELMENCO Capacitors to Distributors and Jobbers in U.S.A. and Canada

Circle 136 on Inquiry Card

Another New High Order of Reliability!

El-Menco

* MYLAR-PAPER DIPPED CAPACITORS

TYPE
MPD

ASSURE A LOW FAILURE RATE OF
Only 1 Failure in 7,168,000 Unit-Hours for 0.1 MFD Capacitors*

14,336,000

Setting A New High Standard Of Performance!

★ Life tests have proved that El-Menco Mylar-Paper Dipped Capacitors — tested at 105°C with rated voltage applied — have yielded a failure rate of only 1 per 1,433,600 unit-hours for 1.0 MFD. Since the number of unit-hours of these capacitors is inversely proportional to the capacitance, 0.1 MFD El-Menco Mylar-Paper Dipped Capacitors will yield **ONLY 1 FAILURE IN 14,336,000 UNIT-HOURS.**

CAPACITANCE AND VOLTAGE CHART

• Five case sizes in working voltages and ranges:

200 WVDC —	.018 to .5 MFD
400 WVDC —	.0082 to .33 MFD
600 WVDC —	.0018 to .25 MFD
1000 WVDC —	.001 to .1 MFD
1600 WVDC —	.001 to .05 MFD

SPECIFICATIONS

- **TOLERANCES:** 10% and 20%. Closer tolerances available on request.
- **INSULATION:** Durez phenolic, epoxy vacuum impregnated.
- **LEADS:** No. 20 B & S (.032") annealed copper clad steel wire crimped leads for printed circuit application.
- **DIELECTRIC STRENGTH:** 2 or 2½ times rated voltage, depending upon working voltage.
- **INSULATION RESISTANCE AT 25°C:** For .05MFD or less, 100,000 megohms minimum. Greater than .05MFD, 5000 megohm-microfarads.
- **INSULATION RESISTANCE AT 105°C:** For .05MFD or less, 1400 megohms minimum. Greater than .05MFD, 70 megohm-microfarads.
- **POWER FACTOR AT 25°C:** 1.0% maximum at 1 KC

These capacitors will exceed all the electrical requirements of E. I. A. specification RS-164 and Military specifications MIL-C-91B and MIL-C-25C.
Write for Technical Brochure

MINIMUM LIFE EXPECTANCY FOR *1.0 MFD *MYLAR-PAPER DIPPED CAPACITORS AS A FUNCTION OF VOLTAGE & TEMPERATURE

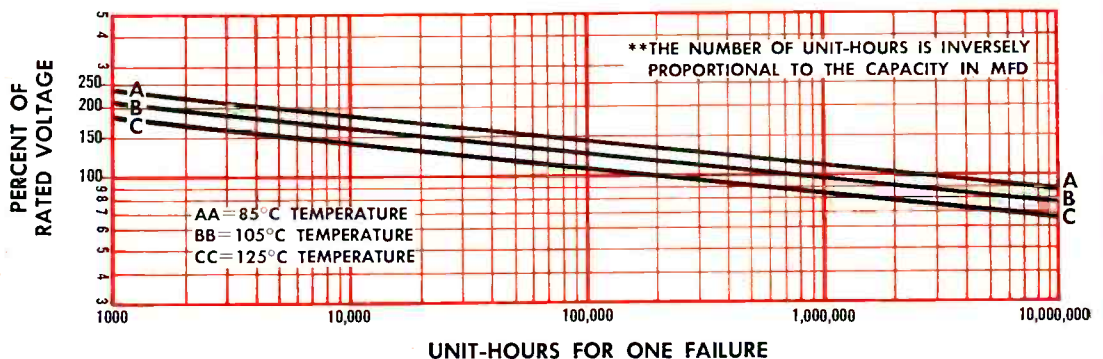

*Registered Trade Mark of DuPont Co.

THE ELECTRO MOTIVE MFG. CO., INC.

Manufacturers of El-Menco Capacitors

WILLIMANTIC CONNECTICUT

- molded mica • mica trimmer • dipped mica • silvered mica films
- tubular paper • mylar-paper dipped • ceramic feed-thrus • ceramic discs

Arco Electronics, Inc., Community Drive, Great Neck, L.I., New York
Exclusive Supplier To Jobbers and Distributors in the U.S. and Canada

WEST COAST MANUFACTURERS CONTACT:
COLLINS ELECTRONIC SALES, INC., 535 MIDDLEFIELD ROAD, PALO ALTO, CALIFORNIA

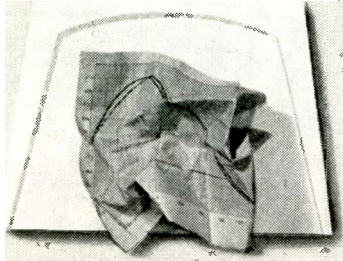

WHATEVER HAPPENED TO A-C QUADRATURE?

Helipot got rid of it, that's what... by designing new A-C potentiometers with low quadrature and negligible phase shift!



They are the 3" diameter 5800 single-turn series and the 2" 7800 multi-turn series. Both have high input impedance and low output impedance. Which means: 1) reduced loading effects, and 2) you'll wonder where the quadrature went.

Helipot's new A-C versions straddle a frequency range of 400 to 1,000 cps. And they can be built to provide exceptional linearities... within resolution and without padding!

You'll also find it well to remember that Helipot's A-C potentiometers can be cascaded in series or parallel to obtain unique functions. (And, with low quadrature and all, they'll improve signal-to-noise ratios in high performance servos!)

To find out more about Helipot's A-C pots, ask for our new 32-page potentiometer catalog!

Beckman Helipot

POTS : MOTORS : METERS

Helipot Division of
Beckman Instruments, Inc.
Fullerton, California

© 1961 B.I.I. 61248

Circle 138 on Inquiry Card

Gradiation Method

(Continued from page 115)

Holding the temp. at the exact predetermined level and distributing the radiant heat uniformly are vital to the establishment of proper crystalline formation, with a resulting loss factor controlled below 0.004 when measured at room temp and 1 mc. Dimensions within workload are held to ± 0.003 in.

After 5 hr, the burners are shut off and the workload is allowed to cool slowly to approx. 1000° F in-

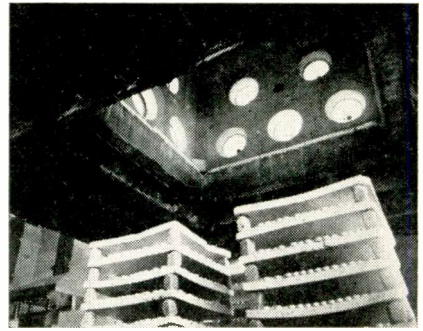
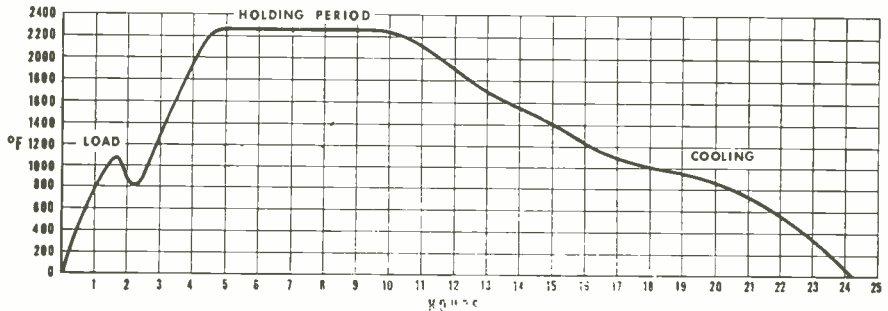

Fig. 3: Heating chamber shows pattern of the Duradiant burners in one wall.

side the kiln before being lowered and exposed to room temp. This controlled cooling, which takes about 15 hr, prevents spalling of the workpieces and furnace lining.

Fig. 4: Heating operation.



new

SHEETS TO 20" x 35" NOW IN STOCK

"V" IS FOR VECTORBORD

Make circuits the fast, easy way... simply insert Vector Push-in Terminals and component wires into the pre-punched terminal board. Six patterns available with .062 and .093 holes, in XXXP Phenolic, G-7 Glass Silicone, G-10 Glass Epoxy and Paper Epoxy. Also available in copper clad.

Write for complete information to

VECTOR ELECTRONIC COMPANY

1100 FLOWER STREET, GLENDALE 1, CALIFORNIA

TELEPHONE: CHapman 5-1076

Circle 139 on Inquiry Card

product of the pioneer

NOW!



Polaroid® by Polaroid Corporation

OSCILLOSCOPE TRACE RECORDINGS IN JUST 10 SECONDS

BY POLAROID AND DUMONT

WITH THE NEW DUMONT
TYPE 450 CAMERA...
PERMANENT RECORDS OF
SCOPE DISPLAYS IN JUST
10 SECONDS

Almost as fast as readout, versatility extraordinary, permanence unequalled — this describes the new team of 10-second developing Polaroid Land 3000 speed film and the Du Mont Type 450 Recording Camera.

The new Polaroid Land film, with an ASA rating of 3200, gives you a permanent print *10 seconds* after you snap the shutter — and with resolution greater than ever before. Now you can record transients of nanosecond risetime speeds with complete clarity, and have prints available in instants.

Du Mont's most recent contribution to the scope camera field, the Type 450, provides such field-requested features as interchangeable lenses for image ratios from 1:1 to 4.5:1 — and interchangeable backs — to provide records in any size from 4" x 5" to 35 mm. All lenses are equipped with synchro shutters and external electrical connectors for tandem, automatic or remote operation. Mounting mechanisms have been greatly simplified, plus rack and pinion focusing, for additional speed in recording.

DUMONT

ALLEN B. DUMONT LABORATORIES, Clifton, N. J.

Write for complete details on obtaining records in
10 seconds — a new high in speed and versatility

DIVISIONS OF

FAIRCHILD
CAMERA AND INSTRUMENT
CORPORATION

Up-to-the-minute abstracts of articles appearing in the leading foreign electronic engineering journals



ANTENNAS, PROPAGATION

A High-Speed Scanning Radar Antenna, F. Valster. "Phil. Tech." #2, 1961. 7 pp. The construction of a fast-scanning radar antenna is described, based on Rinehart's analogue of a two dimensional Luneburg lens. The antenna consists of two hat-shaped metal plates, which together constitute a waveguide and which convert the circular wave fronts in a given plane from a point source on the circumference into linear wave fronts. (Netherlands, in English.)

Measurements in the Design of VHF and UHF Aerials, H. N. Edwardes. "Proc. AIRE." Oct. 1960. 8 pp. This paper describes briefly measuring techniques used in the development of aerials in the frequency range 50-2000 Mc/s. Experimental work is described to illustrate several of the methods. Simple techniques developed for some of these measurements are described, together with some typical results for a dipole and an easily constructed aerial suitable for television reception. (Australia.)

Dipole Arrays for Transmitting Antennas in the TV Bands IV/V, H. Laub. "Freq." Oct. 1960. 8 pp. Recent knowledge in the proportioning of unit arrays and the development of a self-supported omnidirectional unit that is electrically and mechanically self-contained contribute to the applicability of the dipole array technique also in the UHF range, without sacrificing any of its advantages. (Germany.)



AUDIO

Performance Tests on Loudspeakers, M. T. Haitjema. "Phil. Tech." #12, 1960. 11 pp. Methods of testing loudspeakers are described in which the sound pressure, the electrical impedance and the efficiency are recorded as a function of frequency (20-20,999 c/s) on a strip-chart recorder, while the directivity patterns at different frequencies and the transients produced by the sudden interruption of the electrical signal are displayed on a cathode-ray oscilloscope. (Netherlands, in English.)



CIRCUITS

Meter and Decimeter Resonator Power Oscillators, P. N. Andreyev, G. A. Napolova, M. S. Neiman. "Radiotek" 15, No. 11, 1960. 8 pp. Described in this article is the development of resonator oscillators, for continuous-duty high power generation of following waves: 2.5 meters at 100 KW, 1.5 meters at 60 KW and 40 cm at 40 KW. All three oscillators are of the resonator-type, i.e. containing all-metal construction tetrodes with closed oscillators. (U.S.S.R.)

Millimicrosecond Blocking Oscillator with a Small Operating Capacitance, Y. P. Melnikoff, C. Y. Shatz. "Radiotek" 15, No. 11, 1960. 5 pp. The effective capacitance as well as other circuit parameters of a blocking oscillator considerably affect all periods of pulse formation in the circuit. In this article, relations are derived for the amplitude and duration of the pulse in terms of the circuit parameters. An example is treated at the end of the article. (U.S.S.R.)

Application of Network Theory to the Synthesis of Systems with Distributed Constants, A. L. Feldstein. "Radiotek" 15, No. 11, 1960. 12 pp. Aspects of generalized network synthesis methods are analyzed for application to systems with distributed constants. A method is presented for the synthesis of stepped transitions and stepped filters according to prescribed frequency and with any number of sections. This method is used in this article for the tabulation of five-and-six-step transitions. These tables, together with tables prepared in the previous article, using more elementary methods, comprise a catalog enabling engineering design of transitions with minimum effort and time. (U.S.S.R.)

Thermal Stabilization of AC Transistor Circuits, R. Ulrich. "Prace ITR" Vol. 4, #2(11). 31 pp. The determination method of the emitter current and collector voltage changes necessary to assure the stabilization is given, and the possibility of obtaining those changes by using the linear and non-linear elements is discussed. (Poland.)

Band-Stop Filters Partial Resistance Compensation, R. O. Rowland. "El. Tech." Nov. 1960. 3 pp. A method of achieving resistance compensation in band-stop filters is described. Performance curves and normalized component values are calculated for a 3-pole filter. (England.)

DC Reverse Magnetic Amplifiers with Increased Efficiency, M. A. Bojarchenkov and M. A. Rozenblatt. "Avto. i Tel." November 1960. 11 pp. Conditions of getting an increased efficiency for dc reverse magnetic amplifiers are determined. New reverse amplifiers answering the said conditions including the amplifiers without transformers with increased efficiency are shown. (U.S.S.R.)

Calculation of Circuits for Stabilization of Compound Drives Using Special Three-Winding Transformer, O. B. Rosenbauli and R. N. Rodin. "Avto. i Tel." November 1960. 11 pp. The calculation of parameters of stabilization circuits for dc and ac compound drive speed with using special 3-winding transformers is described. The grapho-analytical method is given for plotting characteristics of the drive stabilization circuit taking into account non-linearity of the magnetization curve of the 2-winding transformers. (U.S.S.R.)



COMMUNICATIONS

A Method of Double-Band, Suppressed Carrier Reception, V. N. Arzumano, I. A. Tzikin. "Radiotek" 15, No. 11, 1960. 6 pp. A method of receiving double-band AM signals with a suppressed carrier is described. An investigation of the operation of a system is made, which synchronizes the local oscillator for the reception of speech signals. The influence of certain types of noise on the receiving process

REGULARLY REVIEWED

AUSTRALIA

AWA Tech. Rev. AWA Technical Review
Proc. AIRE. Proceedings of the Institution of Radio Engineers

CANADA

Can. Elec. Eng. Canadian Electronics Engineering
El. & Comm. Electronics and Communications

ENGLAND

ATE J. ATE Journal
BBC Mono. BBC Engineering Monographs
Brit. C.&E. British Communications & Electronics
E. & R. Eng. Electronic & Radio Engineer
El. Energy. Electrical Energy.
GEC J. General Electrical Co. Journal
J. BIRE. Journal of the British Institution of Radio Engineers
Proc. BIEE. Proceedings of Institution of Electrical Engineers
Tech. Comm. Technical Communications

FRANCE

Ann. de Radio. Annales de Radioelectricite
Bull. Fr. El Bulletin de la Societe Francaise des Electriciens
Cab. & Trans. Cables & Transmission
Comp. Rend. Comptes Rendus Hebdomadaires des Seances
Onde. L'Onde Electrique
Rev. Tech. Revue Technique
Telonde. Telonde
Toute R. Toute la Radio
Vide. Le Vide

GERMANY

AEG Prog. AEG Progress
Arc. El Uber. Archiv der Elektrischen Uebertragung
EI Rund. Elektronische Rundschau
Freq. Frequenz
Hochfreq. Hochfrequenz-technik und Elektroakustik
NTF. Nachrichtentechnische Fachberichte
Nach. Z. Nachrichtentechnische Zeitschrift
Rundfunk. Rundfunktechnische Mitteilungen
Vak. Tech. Vakuum-Technik

POLAND

Arch. Auto. i Tel. Archiwum Automatyki i Telemechaniki
Prace ITR. Prace Instytutu Tele-I Radiotechnicznego
Roz. Elek. Rozprawy Elektrotechniczne

USSR

Avto. i Tel. Avtomatika i Telemekhanika
Radio. Radio
Radiotek. Radiotekhnika
Rad. i Elek. Radiotekhnika i Elektronika
Iz. Acad. Bulletin of Academy of Sciences

• Photocopies of all foreign articles are available at 75 cents per page, remitted with order. Unless otherwise indicated, articles appear in language native to country of origin.

• A reprint of this section, "International Electronic Sources" is available without charge.

Requests for the above should be sent, on company letterhead, to:

Electronic Sources Editor
ELECTRONIC INDUSTRIES
Chestnut & 56th Sts.
Philadelphia 39, Pa.

NOW!... A ONE WATT ZENER VOLTAGE REGULATOR...

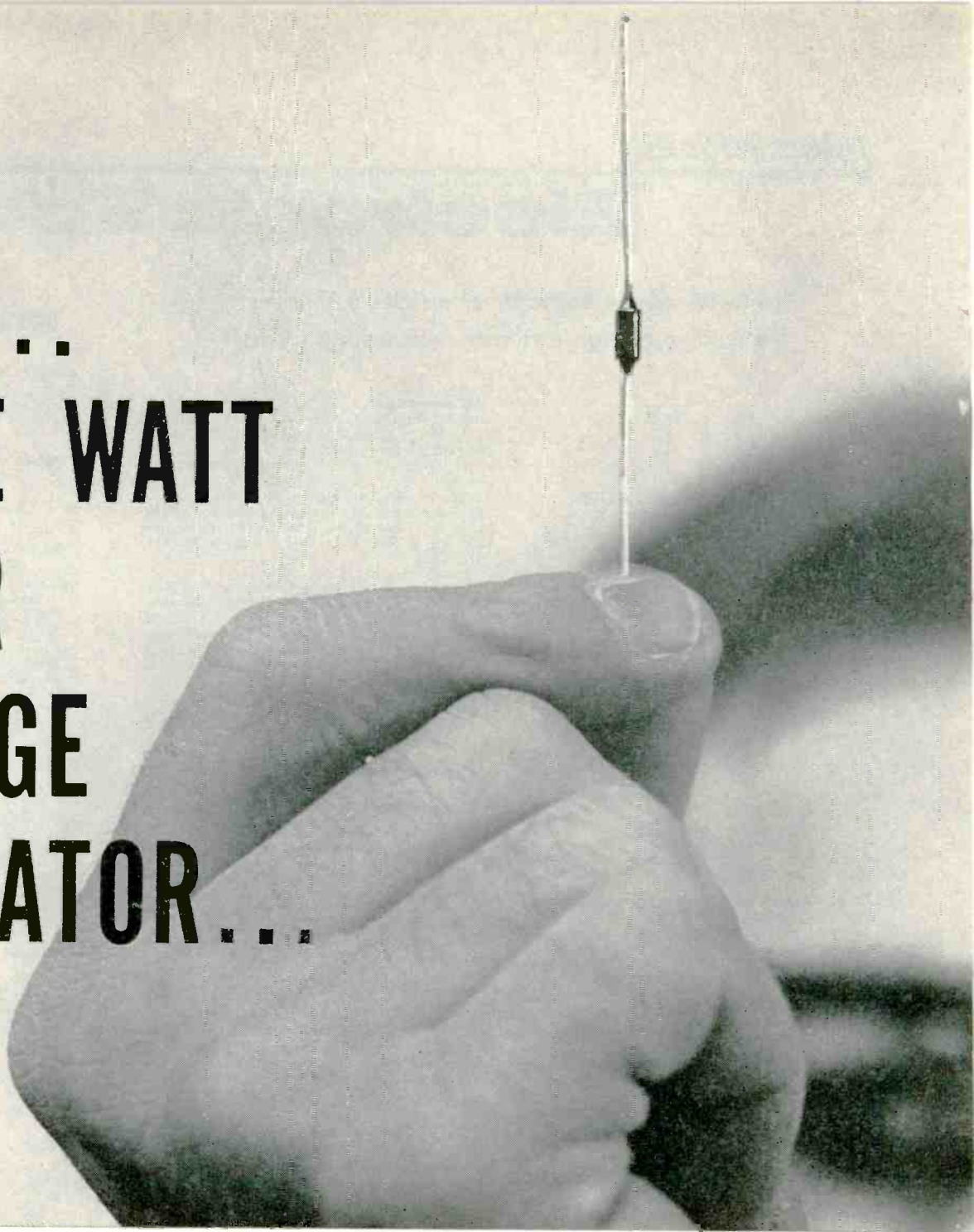

IN THE SMALLEST POSSIBLE PACKAGE!

(ceramic case)

Saratoga Semiconductor Division introduces the first one (1) Watt Silicon Zener Regulator in a ceramic case.* It combines high power with low weight; rugged construction in the smallest possible package; requires less than one fifth (1/5) the space of equivalent units.

The power rating is one watt at 25°C air ambient — derate 8 milliwatts per degree centigrade above 50°C. Ratings from 9.1 volts to 200 volts are available in $\pm 10\%$ or $\pm 5\%$ tolerances.

Send for our technical data sheet 10-223 for complete details and specifications.

SARATOGA SEMICONDUCTOR DIVISION, Saratoga Springs, N.Y.

ESPEY MFG. & ELECTRONICS CORP.

* Meets all requirements of MIL-E-1 and MIL-s-19500B

Circle 142 on Inquiry Card

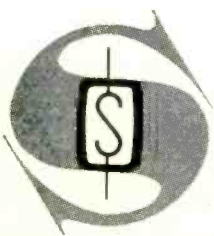

is considered. Results of experimental investigations are given. (U.S.S.R.)

A Multi-Option Terminal Circuit for Carrier-Telephone Circuits. W. Auer and H. Bendel. "Freq." Nov. 1960. 7 pp. The multi-option terminal circuit described can be adapted to the modes of operation of carrier systems by replaceable component groups and to the exchange facilities by transfer switches. The adoption of novel circuit principles simultaneously allowed high compactness and reliability to be attained. (Germany.)

Pulseposition Modulation System for 60 Voice Channels. A. Koelbl. "Freq." Oct. 1960. 3 pp. Despite moderate requirements on bandwidth, this system satisfies all recommendations of the CCI with a minimum of technical effort per voice channel, a minimum of space requirements and power consumption, and extreme simplicity of operation and maintenance. (Germany.)

Launching Over the Sea of Vertically Polarized Waves for Long Distance Ionospheric Propagation. E. O. Willoughby. "Proc. AIRE." Sept. 1960. 7 pp. Simple vertically polarized aerials of most heights of 150 ft. or less launching over the sea are shown to be capable of gains exceeding 14 db over a frequency band of the order of 5-15 Mc/s with good matching and efficient radiation between 1° and 10° elevation. This is much superior to what can be achieved with any land-based aerial vertically polarized or horizontally polarized, of similar height. (Australia.)

Pulseposition Modulation System for 60 Voice Channels. A. Koelbl. "Freq." Oct. 1960. 2 pp. (Germany.)

Intermodulation Measurements on Multichannel Carrier Equipment. A. W. Thies. "Proc. AIRE." Oct. 1960. 4 pp. The effects of intermodulation distortion on multichannel carrier telephony systems are outlined. Important aspects of single-tone, two-tone and noise leading measurements are elaborated, some indirect methods are mentioned. Emphasis is on unit and system testing. Some of the more difficult component tests are included. (Australia.)

The Transmission Paths and Line Equipment. J. S. Caplin. "Brit. C.&E." Dec. 1960. 4 pp. This article describes the functional operation of the transmission equipment, with its high speed control, and also that part of the setting up apparatus which operates at high speed. It shows how lines may be connected through the exchange to common control equipment, and, ultimately, to other lines on the exchange. (England.)

General System Description. L. R. F. Harris. "Brit. C.&E." Dec. 1960. 3 pp. This article outlines the main features of the electronic exchange which is to be installed at Highgate Wood in North London. The formation of the Joint Electronic Research Committee in 1956 enabled the Post Office and the principal British telephone switching manufacturers to pool their electronic telephone exchange research effort. (England.)

The Register Equipment. B. D. Simmons. "Brit. C.&E." Dec. 1960. 3 pp. Calls using register do so by means of trains of pulses occurring at different times in a cycle but on a single common highway. Information is therefore stored and processed using the same pulse positions. Storage and logical gating circuits are thus time-shared among all calls set up at any period. The stores comprise magnetostrictive delay lines, and the logical circuits use diode-resistor gates and transistor buffer amplifiers. (England.)

Supervisory Equipment. A. D. Martin. "Brit. C.&E." Dec. 1960. 4 pp. Exchange apparatus has to be capable of carrying out certain control operations on each connected line during a call, including such things as the provision and removal of dialing number unobtainable, busy, and ringing tones. But these are just some of the functions of the supervisory equipment; it also has to provide several other

control instructions related to the state of the call. (England.)

A Review of Electronic Exchange Developments. T. H. Flowers. "Brit. C.&E." Dec. 1960. 3 pp. This article reviews the electronic telephone exchange principles which are known to be in development throughout the world. (England.)

Transatlantic Cables. "Nach. Z." Dec. 1960. 7 pp. After a retrospect on submarine telegraph cables, submarine telephone cables with balanced pairs and amplifier as well as radio links for telephone channels the new technique of coaxial transatlantic cables and the possibilities of increasing the number of channels (TASI) and a narrow transmitted frequency band per channel) are described. (Germany.)

The Results and the Experience Gained from a Transhorizon Link within the Long Distance Communication Network of the Federal German Post Office. E. Dietrich. "Nach. Z." Dec. 1960. 4 pp. The Federal German Post Office operates two 120 channel transhorizon links in the 2000 Mc/s band between Berlin and West Germany. Experience has shown that these links are suitable for automatic telephony, telegraphy and carrier frequency program transmission. The paper includes statements relating to the transmission quality obtained and the reliability. The long-term and short-term behavior of the links is discussed with the aid of records. (Germany.)

The Results from the Evaluation of Measurements of Tropospheric Transhorizon Propagation on Several Links with a Different Nature in Central and Southeast Europe. H. Carl. "Nach. Z." Dec. 1960. 5 pp. Measurements are given on 12 links with a length of 230 to 400 km covering purely cross-country and purely overseas links as well as composite links. Altitude of the stations is between 0 and 1800 m. Measurement periods are 4 weeks in each case between February and May. (Germany.)

A Method for Transmission of Stereophonic Broadcast Programs. E. Frank and J. Ratsch. "El. Rund." Nov. 1960. 4 pp. The HMD system (Half-wave Modulation with Difference Control) permits the transmission of two programs on a common carrier for radio stereo reception. (Germany.)



COMPONENTS

Determination of the Series Resonance of a Crystal. L. A. Korneyev. "Radiotek" 15, No. 11, 1960, 2 pp. The author presents a circuit for the measurement of the series resonant frequency of a crystal. The method itself is based on the determination of the transfer function of this measuring circuit. This circuit consists of a voltage divider between the crystal and a measuring capacitor. Measurement and tabulation of these voltages permit to evaluate the resonant frequency of the crystal. (U.S.S.R.)

Aspects of Accelerated Testing of Radio Components for Service Life Using a Method of Continuous Voltage Increases. S. N. Koykoff, A. N. Tzikin. "Radiotek" 15, No. 11, 1960, 4 pp. A new method was offered, which permits accelerated testing of paper capacitors by continuous increase of voltage. The authors analyze various aspects of this method and on the basis of mathematical calculations give their opinions and conclusions about the accuracy and validity of results obtained by the above method. (U.S.S.R.)

A Magnetically Controlled, Coaxial Attenuator Element with Small Basic Loss. J. Deutch and M. Ofner. "Freq." Oct. 1960. 4 pp. Variable attenuator elements for microwaves can be made with gyromagnetic materials, if the applied dc magnetic field is variable. Particularly favorable are such attenuator elements, if the losses with small fields are

utilized and if at that the dc magnetic is so directed as to be in parallel to the magnetic field of the wave in the region of the gyromagnetic material. (Germany.)

Dry Reed Switches in Coaxial Relays for Radio Relay Systems. M. Jung and E. Welz. "Freq." Nov. 1960. 4 pp. Dry reed switches are hermetically sealed components that are outstanding by particular reliability of contact and, because of their shape, qualify particularly well for coaxial contactors as required for transferring and dropping multichannel message bands in the i-f stage at frequencies up to about 100 mc/s. (Germany.)

Construction Analysis of the 3000-Type Telephone Relay Coil. W. Woroszynski and C. Rydzewski. "Prace ITR" Vol. 4, #2(11). 19 pp. Analysis methods and the application examinations of copper front cheek of the coil of telephone relay B1-type (3000-type by English nomenclature) is described. (Poland.)

Certain Relationships for Single-Ended Ringing Choke DC to DC Converters. A. Goral. "Prace ITR" Vol. 4, #2(11). 7 pp. In the paper the duration of both conducting (low emitter-collector impedance) and non-conducting time interval (energy flowing into load) of transistor is determined using the direct integration method, while the boundary conditions of the differential equations set are known. (Poland.)

Narrow-Band Filters with Piezoelectric Resonators. M. Siwa. "Prace ITR" Vol. 4, #2(11). 29 pp. After the determination and a brief description of properties of narrow-band filters with piezoelectric resonators, design principles of these filters based on Kogan- and Cauer-classical method of wave parameters, as well as measuring and tuning methods are given. (Poland.)

Technological Measures for an Improvement of the Reliability of Components. K. H. J. Rottgardt. "Nach. Z." Nov. 1960. 8 pp. The reliability of components cannot be improved by means of tests, but only by improved designs. The precautions taken in all stages of development and production of a component determine its reliability in the future. (Germany.)

The Effect of Humidity on the Electrical Data of Capacitors. H. Veith. "Nach. Z." Nov. 1960. 5 pp. The thermodynamic principles of humidity effects on electrical components as well as the physics of the dependence of isolation resistance, dielectric constant and loss angle on the water contents of the insulating materials in a thermo-dynamic equilibrium are outlined. (Germany.)

Some Properties and Applications of 3-Terminal Capacitors. A. M. Thompson and M. C. McGregor. "Proc. AIRE." Oct. 1960. 5 pp. A 3-terminal capacitor consists of two conductors surrounded by a third. The direct capacitance between the two conductors may be definite and unaffected by the connection of suitable leads. A 3-terminal capacitor is thus most suitable as a standard for small values of capacitance. (Australia.)

Resonance Isolators for Millimeter Waves. H. G. Beljers. "Phil. Tech." #1, 1961. 5 pp. The gyromagnetic resonance effect, which occurs in magnetic materials in the presence of a suitable magnetic field, can be utilized for making non-reciprocal microwave transmission devices, such as directional isolators. (Netherlands, in English.)

Demountable Seals for Glass High-Vacuum Equipment. B. Jonas and G. Seitz. "Phil. Tech." #2, 1961. 6 pp. The method described here of making vacuum-tight demountable glass seals uses a metal ring coated on both sides with a glaze. When the ring is heated, e.g. inductively, the glaze melts and the pre-heated glass parts are then pressed to it from both sides. (Netherlands, in English.)

Practical Utilization of the Binistor. M. Kelton. "El. et Auto." Nov.-Dec. 1960. 4 pp. The binistor is a new trijunction semiconductor de-

vice. Essentially, it exhibits two stable states: open and closed. Its operation is quickly reviewed, and several practical applications are described: ring counters, shift registers, binary counters and memory elements. (France.)

Generation of High Voltage Pulses, K. D. Moser. "El. Rund." Nov. 1960. 5 pp. The most important parts of the delay-line pulse generator affecting the pulse are the delay chain and the pulse transformer. Both shape and pulse are interdependent. A satisfactory, optimum pulse shape is possible only when the delay line is adapted to the properties of the pulse transformer and vice versa. (Germany.)

Application of Ba-Ferrite Magnets to the Spark Generators, R. Lappa. "Prace ITR" Vol. 4, #2(11). 5 pp. Application of Ba-ferrite magnets to the spark generator of the 50 cm³ motor-bicycle has been discussed. (Poland.)

Life Time Investigations on Capacitors, W. Ackmann. "Nach. Z." Nov. 1960. (Germany.)

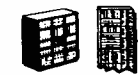

COMPUTERS

Design of High Speed Parallel Solid State Digital Computer, I. C. Hinckfuss, et al. "Proc. AIRE," Sept. 1960. 6 pp. The proposed design of a junction transistor digital computer for the Weapons Research Establishment is presented. The logical operation of the parallel arithmetic unit (adder, subtractor, multiplier, divider and square-rooter), the control unit and the immediate access magnetic core store of 1024, 32-bit words are described. (Australia.)

Magnetic Storage Drum Control, R. D. Allum and R. G. Knight. "Brit. C.&E." Dec. 1960. 3 pp. Automatic telephone Switching Systems are specialized forms of computers, that is machines which are capable of solving logical problems under the influence of external stimuli and to a pattern previously determined. In the case of a telephone switching system these problems relate to the interconnection of subscribers' lines under the control of instructions received from the subscribers. (England.)

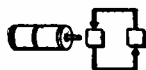

CONTROLS

Dynamics of Self-Adjusting Systems with Extremum Continuous Adjustment of Corrective Networks with Random Disturbances, I. E. Kazakov. "Avto. i Tel." Nov. 1960. 10 pp. Both the problem of estimating accuracy of self-adjusting systems with extremum continuous adjustment of parameters of corrective devices by means of the gradient method and the problem of synthesizing an adjustment net with random disturbances are considered. (U.S.S.R.)

Stability of Nonlinear Controlled System, Chun Dzen-Vey. "Avto. i Tel." Nov. 1960. 6 pp. The solution of a stability problem for a system with an object having a nonlinear characteristic, the system being effected by large initial disturbances are explained. (U.S.S.R.)

Equivalent Transformations of Sequence Machines, A. Sh. Blokh. "Avto. i Tel." Nov. 1960. 7 pp. Some equivalent transformations and sequence machines of the corresponding structure are determined. (U.S.S.R.)

Calculation of Effect of Regular Signal Dynamics in Method of Statistic Linearization, M. I. Gusev. "Avto. i Tel." November 1960.

8 pp. The effect of dynamics of the determined function on the fluctuation transfer coefficient with simultaneous passing through nonlinearity both the regular function and the random one is considered. (U.S.S.R.)

Synthesis of Control Program in Systems Involving Discrete Machines, P. F. Klubnikin. "Avto. i Tel." November 1960. 6 pp. The paper deals with the synthesis problem of a control program of a discrete machine operating in a closed-loop of an automatic control system. The synthesis of the control program according to the given transfer function of the closed-loop system is proposed. (U.S.S.R.)

Determination of Log Frequency Characteristics of Servosystems with Combined Control, A. I. Guzenko. "Avto. i Tel." November 1960. 7 pp. The paper deals with the possibility of replacing a servosystem with combined control which is realized with the help of manipulated variable control by an equivalent servosystem with deviation control only and with a transfer function of the form that is good for analyzing by the method of log frequency characteristics. (U.S.S.R.)



GENERAL

Selection of Optimum Transformation Coefficients in Converter Systems with Impact Excitation, M. V. Agapoff. "Radiotek" 15, No. 11, 1960 3 pp. The author considers aspects in the selection of the optimum transformation coefficient in the circuit of a high-voltage converter. The circuit operates under conditions of impact excitation and feeds electron beam tubes and other devices. A theoretical relationship is given, which permits one to select an approximate value of the transfer coefficient, corresponding to maximum efficiency and to the maximum rectified output voltage. (U.S.S.R.)

Diffraction of a Plane Wave on a Ring Diaphragm, I. N. Kozhevnikov. "Radiotek" 15, No. 11, 1960. 6 pp. The diffraction of a plane wave on a ring with infinite conductivity is analyzed and components of the electric field are found for points lying on the ring's axis of symmetry. The derived expressions can be used in the design of super high frequency antennae, whose reflectors and lenses are ring-shaped. (U.S.S.R.)

Stability of Threshold Waiting Devices With Parameter Losses, I. M. Kogan. "Radiotek" 15, No. 11, 1960. 8 pp. A method to evaluate stability of waiting threshold devices is given, with the help of the introduced "threshold functions." It is shown that parameter losses can lead to a considerable decrease of reliability (stability) of waiting threshold devices. (U.S.S.R.)



SEMICONDUCTORS

The Characterization of Transistors, A. R. T. Turnbull. "Proc. AIRE." Aug. 1960. 10 pp. An active device may be characterized by its terminal properties (circuit parameters) or by parameters directly related to the physical operation of the device (device of parameters). This paper discusses the small signal characterization of transistors in terms of device parameters. (Australia.)

A Modification of the Theory of the Variation of Junction Transistor Current Gain with Operating Point and Frequency, A. W. Matz. "ATE J." Jan.-Jul. 1960. 14 pp. A modified

solution is discussed of the continuity equation for minority carrier flow in junction transistors, obtained by adhering strictly to the space-charge neutrality approximation and applying alternative boundary conditions which differ from those usually taken principally in that a finite minority carrier density is permitted at the collector. (England.)

The Unijunction Transistor, M. Simon. "el. & auto." Sept. 1960. 4 pp. The physical operation of the unijunction transistor is outlined; its characteristic curve is derived and exhibits a negative resistance region. (France.)



TELEVISION

Standards Converter for Television Exchanges Between Europe and North America, A. V. Lord. "Rundfunk." Oct. 1960. 4 pp. The author begins with an investigation of the basic possibilities of standards conversion of television signals for the purpose of program exchanges between Europe and the United States of America. He shows, in particular, the difficulties that arise when the two vertical frequencies are not the same. In this connection, an automatic control device is described, which obviates to a large extent the resulting flicker. (Germany.)

A New Vertical Time Base, E. M. Cherry. "Proc. AIRE." June 1960. 7 pp. This paper is a description and detailed analysis of a new circuit for the vertical time base in TV receivers. The circuit, which requires no close tolerance, undesirable values, or special components, has several advantages over present time bases. (Australia.)

Flying-spot Scanners for Color Television, H. van Ginkel. "Phil. Tech." #8, 1960. 7 pp. Flying-spot scanners as signal sources for color television have an advantage over cameras, in that they are completely free from register errors. In work on color television wide use is therefore made of flying-spot scanners for generating the three primary-color signals. (Netherlands, in English.)

Operational Experience with a 10-KW-Band-IV Television Transmitter with Klystron Output Stage, A. Kolarz & A. Schweisthal. "Rundfunk." Oct. 1960. 7 pp. (Germany.)

Waveform Testing of Television Transmission Facilities, A. J. Seyler and J. P. Potter. "Proc. AIRE." July 1960. 9 pp. The purpose of the paper is to give a critical survey of the methods and ramifications of waveform testing of television transmission facilities. (Australia.)



TRANSMISSION

Engineering Calculation of Impedance Transmission Lines, Taking into Account Earth's Actual Influence, A. S. Kniazeff. "Radiotek" No. 9, 1960. 12 pp. The method of directed EMF's is applied to engineering calculations of the impedance of transmission lines of random length, which are located close to the earth with real electric properties. Formulae are derived for the calculation of impedance for some of the simplest radiating systems. The formulae are verified by comparing theoretical and experimental results. (U.S.S.R.)

Transmission of Pulse Signals Thru a Low-Q Amplifier, G. V. Voyshvillo, V. S. Davydoff, N. V. Solovyev. "Radiotek" No. 10, 1960. 6 pp. The transmission of pulse signals, consisting of step and ramp functions, through a tuned low-Q amplifier is analyzed. The amplifier consists of identical resistance or single-circuit cascaded stages. The number of

CRCA RESISTORS
FIXED • ADJUSTABLE
PRECISION • ULTRA-PRECISION

Ultimate Reliability: Unparalleled no rejects" record since 1953
Immediate Deliverability: .01% resistors are made to order in 24 hours.
Largest Selection: Hundreds of standard types and models.

PRODUCTS	CRCA BULLETIN #
Rotohmeters*: Minute, Ultra-Precision User Adjusted Resistors	R-65
Plug-Trims* Plug-in Resistors and Socket Blocks for Divider, Decade or Trimmer Assemblies	R-55
Instruments: .0002% Voltage Dividers .01% Wheatstone Bridges .01% Resistance Decades	R-50
Banana-Plugs, Resistors*: Axial, Radial, & One Sided Types, Also Jacks	R-44
R-Stacks*: Multi-Tap, Fixed and Adjustable Resistors and Dividers	R-40
Series "200's": Standard design Lug and Wire Lead Resistors *Patents Applied For	R-28

For abbreviated performance data see specs below or EEM, 1960 edition, page 1263.

GENERAL RESISTOR SPECIFICATIONS

Type: Wire-wound, also carbon and metal film.
Range: .01 ohms thru 20 Megohms
Absolute accuracy: 1% thru .005% (at 25°C)
Relative accuracy: thru .001%
Long term stability: thru .001%
Temp. coefficient: thru 2 ppm/°C.
Power dissipation: thru 3 watts at 125° V.
MIL. Specs: MIL-R-93A and MIL-R-9444 (applicable sections)

DELIVERY: 4 weeks regular, 1 week thru 24 hours—Special

CONSOLIDATED RESISTANCE COMPANY OF AMERICA, INC.
44 Prospect St., Yonkers, N.Y. YO 3-5900

Circle 144 on Inquiry Card

EICO 1961

KITS AND WIRED

STEREO
AND MONO
HIGH FIDELITY
TEST INSTRUMENTS
HAM EQUIPMENT
CITIZENS TRANSCEIVERS
RADIOS

LABORATORY PRECISION AT LOWEST COST
Easy checkout, fast to build

Send for **FREE** New 1961 **EICO Electronics Catalog**

EICO, 3300 N. Blvd., L.I.C. 1, N.Y. **EIN-2**
 Send free 32-page catalog & dealer's name
 Send new 36-page Guidebook to HI-FI for which I enclose 25¢ for postage & handling.

Name _____
Address _____
City _____ Zone _____ State _____

EICO 3300 N. Blvd., L.I.C. 1, N.Y.
...praised by the experts
as **BEST BUYS IN ELECTRONICS**

Circle 145 on Inquiry Card

Sources

stages varies between one and three. These results permit to determine the peak instantaneous values of the output voltage determined by the Q of the circuit and the resonant frequency. (U.S.S.R.)

F.S.K. Facsimile Transmission, V. Ramakrishnan and S. Ramachandran. "J. ITE." April 1960. 8 pp. A system of frequency shift keying of facsimile transmission based on a method of deriving single sideband, first suggested by Weaver,² is described. An analysis employing the rotating vector method and certain practical aspects are discussed. (India, in English.)

Results of Approximate Calculations of the Space Wave Fieldstrength at the Limits of the Transmission Frequency Band, B. Beckmann. "Nach. Z." Oct. 1960. 3 pp. This paper is a report of further results from a practical application of a semi-empirical formula for the fieldstrength mentioned in an earlier paper. This formula permits a calculation of the fieldstrength when the limits of the transmission frequency range (LUF and operation MUF) are known. (Germany.)

The C300A Small Diameter Coaxial System, B. S. Helliwell and F. Wilkinson. "ATE J." Jan.-July 1960. 19 pp. This system, designed to meet the requirements of the British Post Office and meeting full C.C.I.T.T. transmission standards, provides a transmission path for up to 300 telephony circuits using a pair of small diameter coaxial tubes in buried or aerially suspended cables with associated repeaters installed underground. (England.)

The Minimum Protection Ratio Required Between Two Transmission Channels Amplitude-modulated with the Same Program, W. Freutel & F. Von Rautenfeld. "Rundfunk." Oct. 1960. 13 pp. (Germany.)

Analysis of Some Non-uniform Electric Transmission Lines Using Laplacian Transformation, V. M. Dhise. "J. ITE." April 1960. 3 pp. (India, in English.)



Certain Aspects of the Transit Time of Electrons Between the Grid and the Plate of a Triode, G. A. Zeytlenok. "Radiotek" No. 9, 1960. 7 pp. The solution for the transit angle of electrons in the space between the grid and the plate of a triode is derived on the basis of equations which govern the motion of an electron in AC and DC electric fields. It is given in the form of a harmonic series. Curves of the transit angle versus the initial phase at the start of the transit are included. The influence of the AC voltage amplitude on the magnitude of the transit angle is analyzed. (U.S.S.R.)

An Electrically Tuneable Microwave Oscillator with a High Efficiency and an Output Level Independent of Frequency, W. Eichlin and H. Heynisch. "Nach. Z." Oct. 1960. 5 pp. An electronically coupled combination comprising a backward wave oscillator and a traveling wave tube operating in the region of saturation is described in this paper. (Germany.)

Gas Filled Decade Counter Tube for Frequencies up to 1 Mc/s. "El. Rund." Oct. 1960. 4 pp. The paper deals with problems encountered with high-speed counting using gas-filled cold-cathode counter tubes. (Germany.)

Reflex Klystrons for Wavelengths of 4 and 2.5 mm, B. B. van Iperen. "Phil. Tech." #3, 1960. 8 pp. (Netherlands, in English.)

A Gas-discharge Indicator Tube for Transistorized Decade Counting Circuits, T. P. J. Botden. "Phil. Tech." #9, 1960. 9 pp. (Netherlands, in English.)

* * *

Specify
SPERRY
for
2N327A
2N328A
2N329A
2N330A

SILICON PNP TRANSISTORS

New low levels of I_{CO} baked at 200°C for 200 hours for utmost stability.

Specify Sperry through **AVNET** exclusive Sperry Distributor East of the Rockies. Factory Prices, for quantities 1-999

Call your Avnet Applications Engineer

For dependable service
and immediate delivery
AVNET

* AVNET-70 State St., Westbury, N.Y. - ED 3-5800
 AVNET-45 Winn St., Burlington, Mass. - BR 2-3060.
 AVNET-4180 Kettering Blvd., Dayton 39, Ohio - AX 8-1458
 AVNET-2728 N. Mannheim Rd., Melrose Park, Ill. - GL 5-8160

New from Polarad

ANTENNA PATTERN MICROWAVE RECEIVER

ULTRA-BROADBAND COVERAGE
2,000 to 75,000 mc
in a single unit

- A** External Mixer. May be located at or near antenna, any distance up to 75 feet from receiver.
- B** Flexible cable connects mixer to receiver. Eliminates cumbersome rigid waveguide.
- C** Internal electronic 1000 cps sweep allows direct operation into any standard make AC antenna pattern recorder.
- D** CW, AM, FM and pulse reception.
- E** Sensitivity.
2 kmc to 10 kmc...-85 dbm.
10 kmc to 35 kmc...-80 dbm.
35 kmc to 75 kmc...-70 dbm.
- F** Linearity maintained over 40 db dynamic range.

The Model RW-T is another example of the versatility of the well known Polarad Model R Microwave Receivers. The RW-T is excellent to measure antenna gain, pattern, minor lobes, front-to-back ratio, SWR and bandwidth.



**POLARAD
ELECTRONICS
CORPORATION**

43-20 34th Street, Long Island City 1, N. Y.
Representatives in principal cities.

MAIL THIS CARD
for specifications. Ask your nearest Polarad representative (in the Yellow Pages) for a copy of "Notes on Microwave Measurements."

© P.E.C.



Model RW-T Microwave receiver being used to make antenna pattern measurements on Polarad range.

1234567

POLARAD ELECTRONICS CORPORATION:

Please send me information and specifications on:

POLARAD

- Model RW-T Antenna Pattern Receiver
- Model KSS Microwave Power Source (see reverse side of page)

My application is _____

Name _____

Title _____ Dept. _____

Company _____

Address _____

City _____ Zone _____ State _____

New from Polarad

COMPACT MICROWAVE POWER SOURCE

1,050 to 11,000 mc 4 PLUG-IN UNITS



Model KSS Power Source being used to make antenna pattern measurements on Polarad Antenna Range. Can also be used for minor lobes, front to back ratio, SWR and gain measurements.

The new Polarad Model KSS features an advanced modulator design that provides CW, FM and internal square wave (10 to 10,000 pps). External pulse capabilities permit rise times to 0.15 μ sec. The unit has an adjustable attenuator and low incidental AM and FM at relatively high power.

- A** Basic unit (HU-4) includes modulator and power supply into which is plugged any one of four R-F tuning units
- B** that cover the frequency range 1,050 to 11,000 mc. Tuning units are equipped with UNI-DIAL control **C** that automatically tunes klystron cavity with reflector voltages.

Postage
Will be Paid
by
Addressee

No
Postage Stamp
Necessary
If Mailed in the
United States

BUSINESS REPLY CARD

First Class Permit No. 18, Long Island City 1, N. Y.

POLARAD ELECTRONICS CORP
43-20 34th St., Long Island City 1, N. Y.

POLARAD

MAIL THIS CARD
for specifications.
Ask your nearest
Polarad representa-
tive (in the
Yellow Pages) for
a copy of "Notes
on Microwave
Measurements."

FREE LIFETIME SERVICE
ON ALL POLARAD
INSTRUMENTS

**POLARAD
ELECTRONICS
CORPORATION**

43-20 34th Street, Long Island City 1, N. Y.

© P.E.C.

Representatives in principal cities.

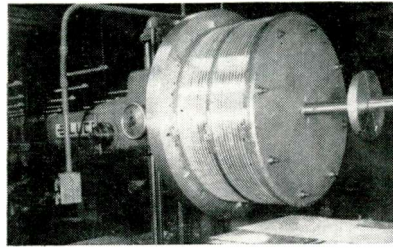

FABRICATED

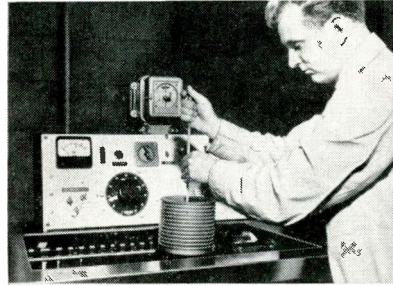

ELECTRO-PLATED

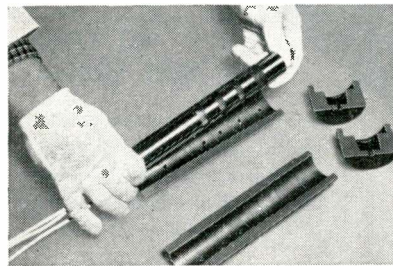

MOLDED

No Compromise

IN THE DESIGN OR PRODUCTION OF CUSTOM SLIP RING ASSEMBLIES...

... at Breeze. With the depth of design and production capabilities and facilities at Breeze Corporations, your slip ring requirements are met without compromise. Breeze produces custom slip ring assemblies by *all* of the reliable methods and techniques, thus assuring you of a unit tailored to meet your unique requirement.

Let Breeze provide you with an uncompromised design and production analysis before you buy.

You'll want a copy of the new Breeze catalog 66SR which describes a wide range of custom units as well as Breeze standard slip ring assemblies.



BREEZE CORPORATIONS, INC.

700 Liberty Avenue, Union, New Jersey • Telephone: MURdock 6-4000

Manufacturers of electrical, electro-mechanical and hydro-mechanical components and systems and fabricated metal products.

new GEN-PRO[®]

AIRCRAFT TYPE TERMINAL BOARDS

New series of Molded Terminal Boards available in three basic types—AN, NAS and MS. Special compoundings, backing strips and hardware on request.

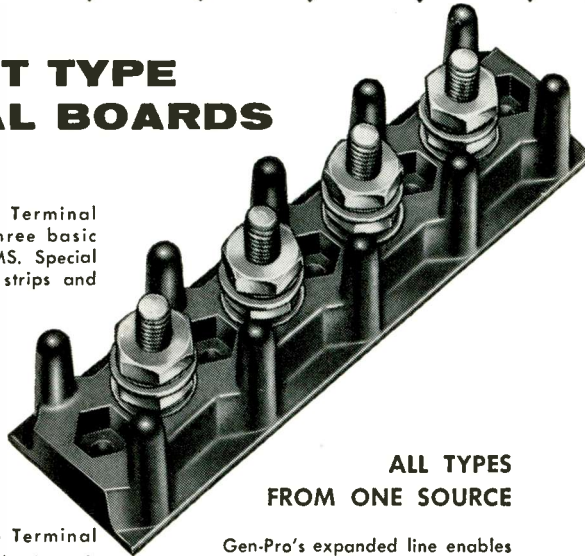

ALL TYPES
FROM ONE SOURCE

Gen-Pro Aircraft Type Terminal Boards — soon available through distributors. Sales and service reps in key U. S. cities. Fast delivery.

WRITE NOW FOR FURTHER DETAILS

Gen-Pro's expanded line enables you to order all types of Terminal Boards from a single source; standard military, commercial, and others for special applications.

GENERAL PRODUCTS CORPORATION

Over 25 Years of Quality Molding

UNION SPRINGS, NEW YORK TWX No. 169

Circle 149 on Inquiry Card

ELECTRONIC • PRINTED CIRCUIT • GRAPHIC

SYMBOLS

MADE TO ORDER

Repetitive symbols . . . in fact any drafting, blueprint or specification detail items . . . can be applied in seconds, rather than drawn in hours. If your engineers or draftsmen haven't yet discovered the speed and economy of STANPAT, they are wasting valuable hours . . . and valuable money.

STANPAT tri-acetate sheets are quickly and easily adhered to your tracings without special equipment. Reproductions are crisp and clean . . . Won't dry out, come off or wrinkle. Mail the coupon today and see for yourself.

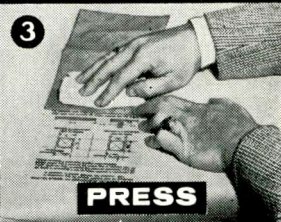
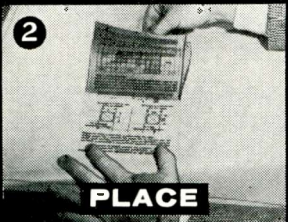

pre-printed • tri-acetate
STANPAT
sheets

Used by more than 30 Industries

STANPAT CO., Whitestone 57, N. Y.

Phone: FLushing 9-1693-1611 Dept. 62

Please quote on enclosed samples
 Kindly send literature and samples

Name _____
Title _____
Company _____
Address _____
City _____ State _____

Study Space Antennas

Caltech's Jet Propulsion Laboratory has selected four companies for a four-month investigation of the feasibility of an advanced space tracking antenna.

Each company will submit a design analysis of a large tracking antenna from 200 to 250 ft. dia. The present DSIF (Deep Space Instrumentation Facility) stations use 85 ft. dia. tracking antennas. If feasible, the advanced antennas would increase DSIF capability 10 to 30 times.

Four companies selected are: Westinghouse Electric Corp., East Pittsburgh, Pa.; Blaw-Knox Equipment Div., Blaw-Knox Co., Pittsburgh, Pa.; Hughes Aircraft Company Ground Systems, Fullerton, Calif.; and North American Aviation, Inc., Columbus, Ohio.

Inflatable Reflector Collects Solar Energy

An inflatable, bowl-shaped reflector for collecting solar energy to operate space power systems has been developed by Goodyear Aircraft Corp., Akron, Ohio. Made of aluminized plastic film, it folds and is packaged in a two-part cylinder. At a predetermined altitude, explosive bolts release and open the container. Compressed gas, forced into the folded reflector opens it up. A lightweight plastic foam then flows between the aluminized surface and an outer wall of film, taking permanent set.

Solar heat collectors as large as 100 ft. in dia. are possible with this technique. The reflector provides over 3 kw for electric power generating systems.

Test Mapping System

A new type of automatic mapping instrument, designed to reduce the time for making contour aerial photographs, is being tested by the U.S. Army Engineer Geodesy, Intelligence and Mapping R & D Agency, Fort Belvoir, Va. The instrument (Stereomat) is a Canadian development by Hunting Associates, Ltd.

The system automates establishing contours for maps made from aerial photography. It uses photoelectric cell "flying-spot" random scanning and other electronic techniques. It can contour a pair of aerial photographs faster than a human and at equal accuracy.

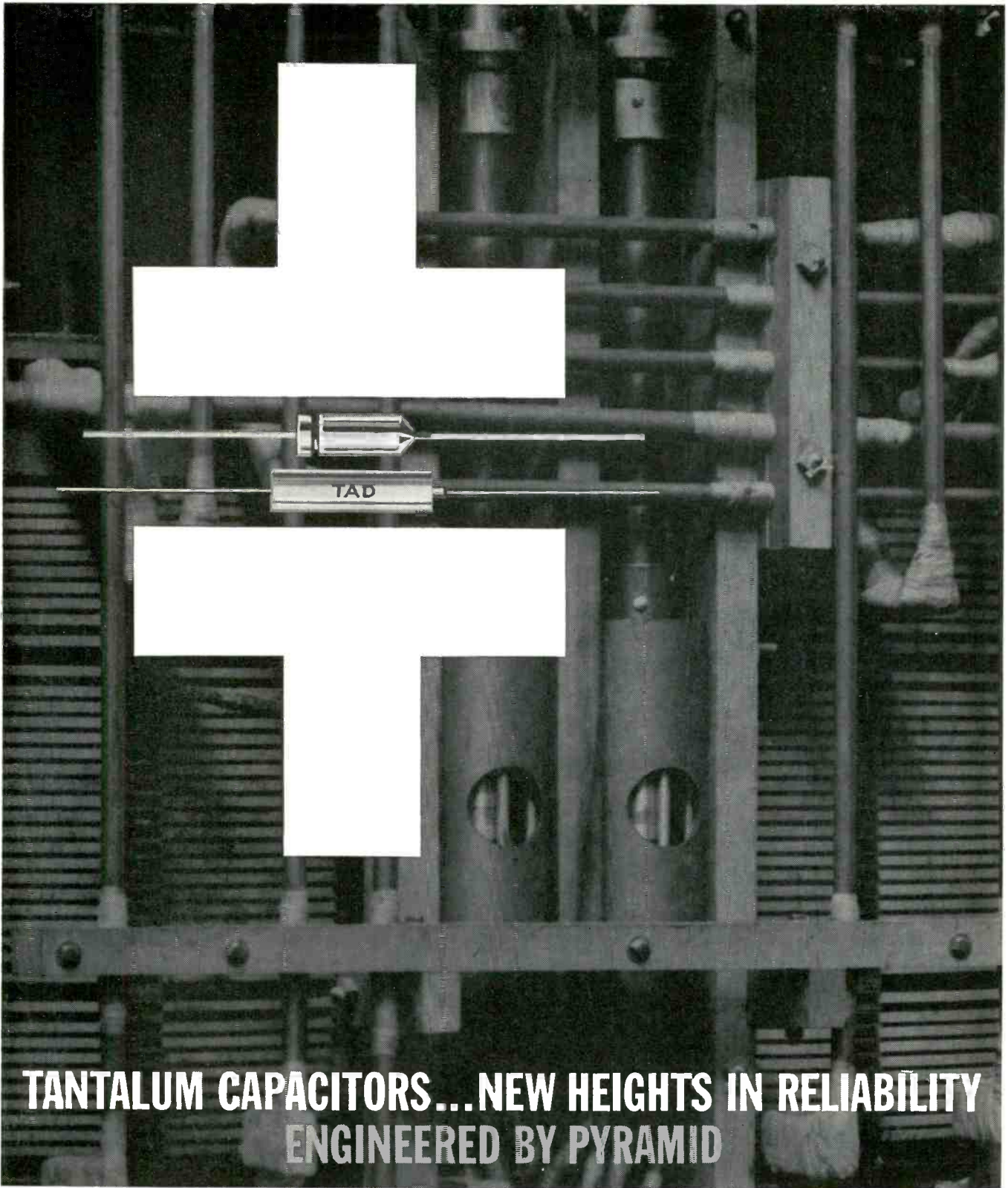

TANTALUM CAPACITORS...NEW HEIGHTS IN RELIABILITY ENGINEERED BY PYRAMID

When Pyramid tantalum capacitors with proven dependability are incorporated into essential electronic equipment you manufacture... greater reliability of your product is assured.

To design engineers searching for miniature electrolytic capacitors with unusual capacitance stability and a low dissipation factor over a wide temperature range, soundly constructed tantalum capacitors are gratifying discoveries.

If the equipment you make demands small capacitors with explicit reliability and peak performance, look to Pyramid for tantalum capacitors that meet your most exacting requirements.

For full details write or call: Sales Department
PYRAMID ELECTRIC COMPANY
DARLINGTON, SOUTH CAROLINA

Canada: Wm. Cohen, Ltd., 8900 Tanguay Street, Montreal
Export: Morhan Exporting Co., 485 Broadway, N. Y. 13, N. Y.



Old Fashioned?

See what **Ungar**
does to
soldering tools
next month!

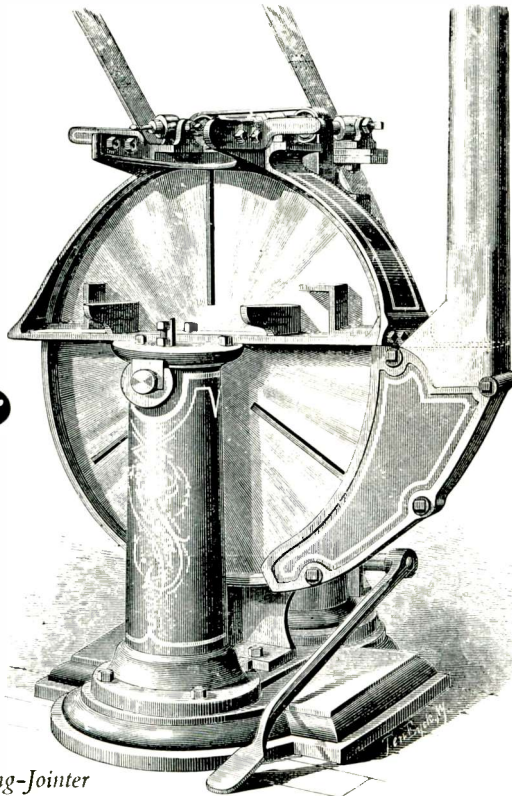

Combined Fan, Heading-Jointer
and Dowel-Borer • E. & B. Holmes • Circa 1885

Circle 152 on Inquiry Card

Engineer Demand Drops

The demand for engineers and scientists dipped slightly in November after rising during September and October.

This demand is measured by the Engineer/Scientist Demand Index developed by Deutsch & Shea, Inc., 230 West 41st St., N. Y.

The Demand Index is based on information supplied by newspapers in major market areas and by technical journals in key engineering and scientific fields. The Index measured the demand for scientific personnel by the advertising in newspapers and scientific journals.

ENGINEER/SCIENTIST DEMAND INDEX Composite Index

July = 100.0

August	97.6
September	107.7
October	116.2
November	113.3

Study the "Flying Fish"

Raytheon Company, Waltham, Mass. will study high-speed navigation of the "Flying Fish," an operational hydrofoil vessel that skims along the water on a pair of hydrofoils at 40 knots.

A principal study will involve methods for presenting radar information to the pilot for rapid and easy reading while traveling at high speeds in congested waterways. Other studies will involve navigational collision avoidance, and data display aspects for both military and commercial applications.

Equipment to be used will include a modified version of the firm's model 1500 Mariners "Pathfinder" radar, memory display system which "freezes" radar data for easy reading.

New Lab at China Lake

The Naval Ordnance Test Station at China Lake, Calif., is building a new Systems Evaluation Laboratory. The 41,000 ft, \$149,000 building will be ready in December.

UMA Elects Officers

The Ultrasonic Manufacturers Association has elected officers for 1961. They are: Stanley E. Jacke (Branson Instruments, Inc.) — President; Samuel Bagno (Kidde Ultrasonic & Detection Alarms, Inc.)—Vice President; and Harvey B. Foulkes, Jr. (Cavitron Equipment Corp.)—Treasurer.

For that

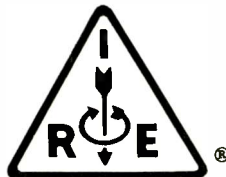

NEW IDEA

visit the

IRE SHOW

March 20-23, 1961

New York

Coliseum and Waldorf-Astoria Hotel

Members \$1.00, Non-members \$3.00

Age limit—over 18



ARNOLD/TOROIDAL COIL WINDER

*sets up quickly...easy to operate...
takes wide range of wire sizes*

SPECIFICATIONS:

- Min. finished hole size: .18 in.
- Max. finished toroid O.D.: 4.0 in.
- Winding speed: 1500 turns/min.
- Wire range: AWG 44 to AWG 26
- Dual, self-checking turns counting system
- Loading (wire length) counter
- Core range: 1/4" I.D. to 4" O.D. to 1 1/2" high

LABORATORY USE

- Change wire and core size in 45 sec.

PRODUCTION USE

- 1500 turns per minute
- Insert core and load in 20 sec.

includes all rings, counters and accessories



immediate delivery, literature on request

ARNOLD MAGNETICS CORP.
6050 W. Jefferson Blvd., Los Angeles 16, Calif.
VERmont 7-5313

Circle 154 on Inquiry Card

WHY YOU SHOULD THINK OF MAPICO WHEN YOU THINK OF IRON OXIDES FOR FERRITES!...

First of all, Mapico provides a wide range of pure synthetic iron oxides... unmatched for uniformity... produced through the most precise automatic production controls... in a plant with tremendous capacity. And Mapico iron oxides are made in three typically different particle shapes, each shape available in many accurately graded particle sizes. The selection of the proper Mapico oxide assists you in controlling electronic characteristics and shrinkage.

MAPICO IRON OXIDES UNIT

COLUMBIAN CARBON COMPANY
380 Madison Ave., New York 17, N. Y.

**DRAFTSMEN!
ENGINEERS!
DESIGNERS!**

TA "King-Size"
Instrument Cases
4 PAGES

TA Standard
Instrument Cases
20 PAGES

Learn how TA's new predesigned Instrument Cases solve your equipment housing problems.

SEND FOR YOUR FREE COPIES!

THESE EXCLUSIVE FEATURES—STANDARD WITH TA—SAVE YOU TIME AND COST

1. Predesigned panel-layouts for perfect fit.
2. Large selection of standard sizes and styles.
3. Wide choice of standard handles, access doors, panels, and other accessories.
4. All standard Cases include panel gaskets.
5. All Cases protected by air relief valves.
6. Available in depths from 2 1/2 to 18 inches.
7. Fast delivery (prototypes in 4 weeks).
8. No tooling charges on standards.
9. Precision quality.
10. Reinforced aluminum construction.
11. TA Cases are color matched to, and integrated with, the instruments they are to contain.

INSTRUMENT MANUFACTURERS: If you make portable instruments or equipment, you can't afford *not* to investigate the TA line.

TA Cases come in a diversity of standard lid sizes, and are sold at proprietary prices. During assembly the depth can be cut to your exact specifications. Or, if you like, TA will furnish you free vellums and templates so you can save yourself money by designing your product to fit one of the many standard sizes.

Start saving big money right away. Send for your valuable free TA manuals *today!*



TA Mfg. Corp. 4607 Alger Street • Los Angeles 39, Calif.
(or call CH 5-3748)
TWX 9863 Glendale, Calif. • WUX CAT Los Angeles, Calif.

Circle 155 on Inquiry Card

WRITE FOR

this useful, free, informative chart on MAPICO pure synthetic iron oxides for ferrites.

MAPICO
PURE SYNTHETIC
IRON OXIDE REAGENTS

Columbian has had 50 years experience in the business of manufacturing pure synthetic iron oxides. They can be produced by several practical procedures to give a variety of characteristic particle shapes and particle size ranges. The methods by which MAPICO® Pure Iron Oxides are manufactured were chosen because they enable careful control of preselected characteristics.

MAPICO PURE IRON OXIDES

(a) are strictly uniform from shipment to shipment
(b) are reacting at the high temperature customarily used in the ceramic industry
(c) are available in three different particle shapes any of which may be held in several ranges of particle size
(d) are of high purity and free from harmful impurities
(e) give controlled shrinkage
(f) are controlled electronic characteristics
(g) are produced in ample supply by a large modern, technically advanced plant

MAPICO PRODUCTS	COMPOSITION	PURITY	SHAPE	SIZE RANGE	TYPICAL CHEMICAL ANALYSIS														
					Fe	Al	Si	Ca	Mg	Mn	Ni	Cu	Zn	Pb	As	Sb			
Fe-1	oxide	0.4-0.8	224	14	20	99.2	1.5	0.4	0.5	0.01	0.01	0.01	0.01	0.01	0.01	0.01	0.01	0.01	0.01
Fe-1+	oxide	0.4-1.2	4.7	18	40	99.2	1.5	0.4	0.5	0.01	0.01	0.01	0.01	0.01	0.01	0.01	0.01	0.01	0.01
Fe-2	oxide	0.4-1.2	3.5	37	54	99.2	1.5	0.4	0.5	0.01	0.01	0.01	0.01	0.01	0.01	0.01	0.01	0.01	0.01
Fe-110-2	oxide	0.3-1.2	8.7	29	71	98.9	0.5	1.0	0.5	0.01	0.01	0.01	0.01	0.01	0.01	0.01	0.01	0.01	0.01
Fe-40	oxide	0.3-1.2	5.4	33	67	99.1	0.5	1.0	0.5	0.01	0.01	0.01	0.01	0.01	0.01	0.01	0.01	0.01	0.01
Fe-80	oxide	3.8-5.4	2.4	15	00	99.2	0.5	1.0	0.5	0.01	0.01	0.01	0.01	0.01	0.01	0.01	0.01	0.01	0.01

Circle 156 on Inquiry Card

SLASH POWER REQUIREMENTS

DEFLECTION • GRID DRIVE • HEATER

WITH

DU MONT

LOW DRIVE DISPLAY TUBES

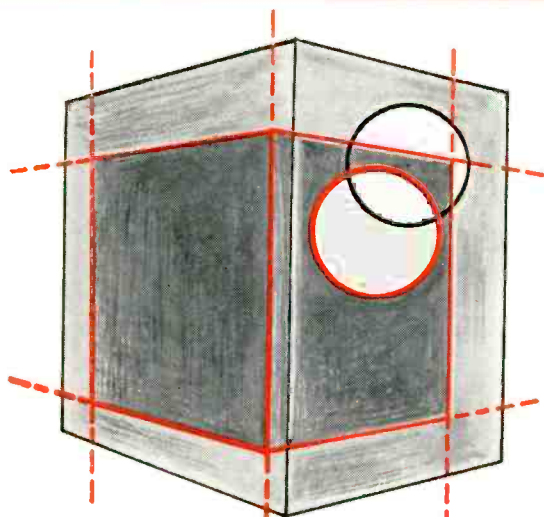

CUT SIZE AND WEIGHT
OF YOUR EQUIPMENT

DU MONT

ALLEN B. DU MONT LABORATORIES, Clifton, N. J.

Another significant breakthrough in cathode-ray display tube design by Du Mont—low-drive tubes **SLASHING POWER REQUIREMENTS** for deflection, grid drive, and heater-shrinking associated circuitry, and making possible the use of transistorized circuits. Bulky instruments become compact. Heavy equipment becomes portable.

Now, your choice of 3", 5", 7" round, or 3½" square sizes in low-drive designs. New high-efficiency phosphors provide bright displays, even under toughest ambient light conditions. These tubes are ideal for oscilloscope use or any display function from video sources.

SAMPLES AVAILABLE NOW...

Right now you can start your design work around these new Du Mont display tubes. Write for complete details including deflection blanking (Beam gating)...

DIVISIONS OF

FAIRCHILD
CAMERA AND INSTRUMENT
CORPORATION

Tele-Tech's ELECTRONIC OPERATIONS

The Systems Engineering Section of ELECTRONIC INDUSTRIES

FEBRUARY 1961

SYSTEMS—WISE . . .

▶ The Air Force has ordered 10 service test models of a newly-developed digital modem (modulator-demodulator) which transmits up to 5400 bits/sec. over telephone or telegraph lines. Rome ADC, Griffiss AF Base, N. Y., sponsored development of the data modem, AN/GSC-4. Collins Radio Co., Western Div., built the units.

Acoustic Test Facility



Recently installed and operating at American Labs. Div., American Electronics, Inc., Fullerton, Calif. New facility tests electronic components and sub-assemblies under actual conditions encountered in jet and rocket propelled missiles and aircraft.

▶ A battery-operated electronic computer, PB 250, has been shown by Packard Bell Computer Div., Packard Bell Electronics. In normal operation, it operates from a battery trickle charged from a 115-v. power line. If 115-v. input is interrupted, computer can continue operating for more than 1 hr.

▶ New system unites a high-resolution TV system with high magnification Elgeet Optical Co. research microscopes in a new optical magnification system developed by Allen B. DuMont Labs and Sylvania Electric Products, Inc. System closes a gap between 2,000 X and 5,000 X magnification starting point of electron microscopes.

▶ Two Remington Rand Univac Solid-State Computers, one utilizing magnetic tape, have been installed in the new Kaiser data processing center in Oakland, Calif. The computers will integrate accounting procedures and improve report schedules. They also plan to use them to solve complex engineering problems and investigate areas in operations research and management sciences.

▶ New combustion programming system from General Controls Co., Glendale, Calif., gives split-second electronic detection of flame-out and enables immediate shut-down of industrial and commercial combustion facilities. System uses a small ultraviolet detector tube to detect presence of flame.

▶ New Automatic Communications Relay Station, now operating at Fort Detrick, Md., completes the Army's new Domestic Communications Network. The station's automatic message switching system can receive, process, and retransmit messages at the rate of 275,000 a day. Station can store 5,000 messages at a time and route a message through the switching system in 3 sec. Other relay stations are at Davis, Calif., and Leavenworth, Kan. They link domestic commands with Army locations throughout the world. Kleinschmidt Div., Smith-Corona Marchant supplied equipment for Ft. Detrick.

▶ A new electronically controlled system for sorting parcels is being installed in Pennsylvania Station, New York. It can handle 25 boxes, cartons, crates, etc. (Packages which are too large to sack) per min. Capacity is 36,000 parcels/day. System was designed by Stewart-Warner Corp., Chicago.

▶ Feasibility of an "ultrasonic can opener" to aid demolition squads in disarming unexploded bombs is being studied by engineers at Raytheon Co.'s Commercial Apparatus and Systems Div., Norwood, Mass. Aim is to develop a technique for opening steel-encased bombs without generating excessive heat.

▶ Solar cells in Tiros II are optically treated to aid the emittance of the sun's rays in the long wave, or heat, region. Since solar heat impedes photovoltaic action, this enables the silicon cells to operate more effectively. International Rectifier supplied the 9,260 cells for the solar power system built by Radio Corp. of America.

▶ Lockheed Missile and Space Div. scientists propose using a sodium vapor trail to track spacecraft descending from orbit. System would produce clearly visible light, laying a glowing orange-red trail in near-space across hundreds of miles of sky.

▶ New analytical equipment at Gulf Oil's Harmarville Research Labs is speeding the discovery of oil. The system uses an X-ray machine (special circuits minimize noise and increase precision) and an IBM 704 Computer. The computer "memorizes" the characteristics of 35 commonly observed minerals. The equipment analyzes rock cores from the drill hole. Company's scientists hope to develop equipment that can be used directly at the well site.

Electrical Systems Test

Electronic Testing Device, used by Ford Motor Co. Quality Inspectors, checks electrical systems of 1961 Lincoln Continentals. Immediate or impending circuit failures are spotted, corrected and re-checked prior to cars rolling off final assembly line. Device also checks lighting systems, heater, radio, starter, generator, regulator, windshield wipers, air-conditioning, engine speed, and power seat and window operation.



A simple wireless microphone that transmits on the FM broadcast band operates surprisingly well. Complete details for constructing the compact unit are given along with design information for making changes to suit the user's application.

Details for a Transistorized FM Wireless Mike

By **SAMUEL J. LANZALOTTI**

*U. S. Army Research Development Lab.
Fort Monmouth, N. J.*

FOR the professional the wireless mike eliminates the trailing cords associated with the conventional microphone, and will permit him to have greater freedom of movement. The unit is ideal for TV, stadiums, showrooms and schools. For the experimenter, there are any number of uses that can be found for the device with a little imagination.

The wireless microphone consists of an audio amplifier-modulator and a frequency modulated oscillator. The microphone used is a controlled

dynamic with a frequency response of 400 to 4500 CPS. Although the microphone used is limited to the speech frequencies, the circuit is capable of producing higher performance when driven by a mike having a wider frequency response. This microphone was used because of its small size, lightweight and excellent shielding properties that were important considerations in our application.

The mike drives a low noise audio type pnp transistor (2N104). The 2N104 drives another audio

type pnp transistor (2N105). Both stages are in a common emitter direct coupled circuit. The frequency modulated oscillator consists of a diffused Mesa pnp transistor type 2N537 or 2N700 used in a common base circuit.

The oscillator tank coil (which is the antenna) consists of one turn of #22 wire wrapped in a groove around the outside of the case to form a complete loop measuring $2\frac{3}{8} \times 1\frac{3}{4}$ in. The use of the loop eliminates the necessity for an external antenna. Radiation from the loop is adequate for reception on a good FM tuner to a distance of about 250 yards.¹ With a one-turn loop around the case, the capacitance value of the tank capacitor will tune the standard FM broadcast band, 88-108 MC.

FM is accomplished by coupling the modulating signal from the audio amplifier to the base of the oscillator, which causes the oscillator frequency to change. The change is proportional to the amplitude of the audio voltage applied.

Circuit Operation

This is how it works: Since the audio voltage amplitude variations are at an audio rate, deviation of the oscillator frequency will also be at an audio rate; that is, the bias

Fig. 1: Schematic diagram of the wireless mike. Oscillator tank coil is the antenna.

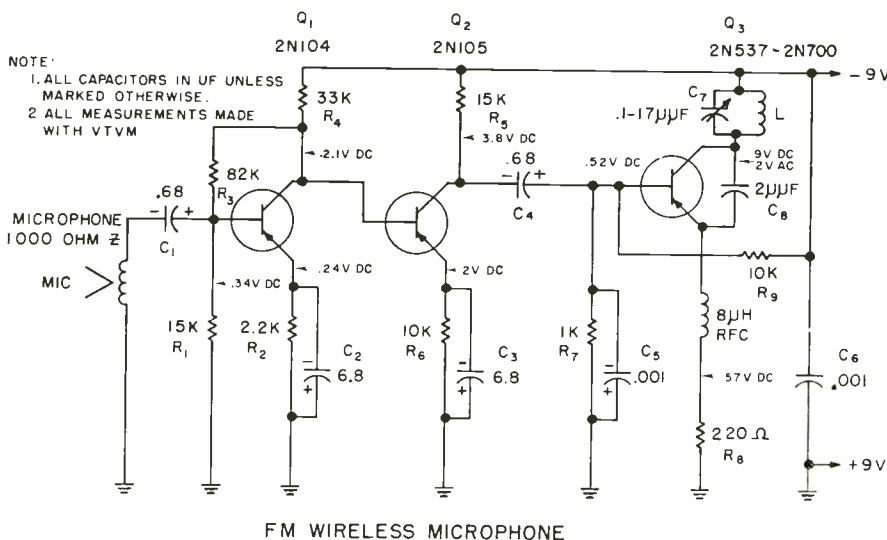

NOTE:
1. ALL CAPACITORS IN UF UNLESS MARKED OTHERWISE.
2. ALL MEASUREMENTS MADE WITH VTVM

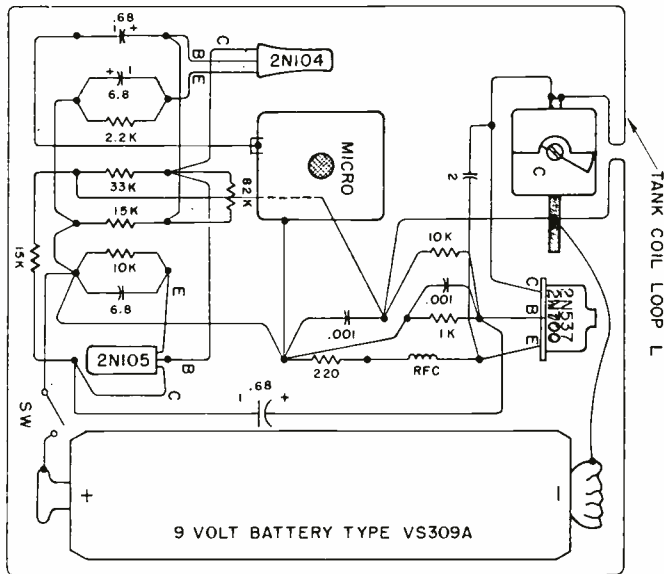

Fig. 3 (right): Unit is shown completely enclosed in its case.

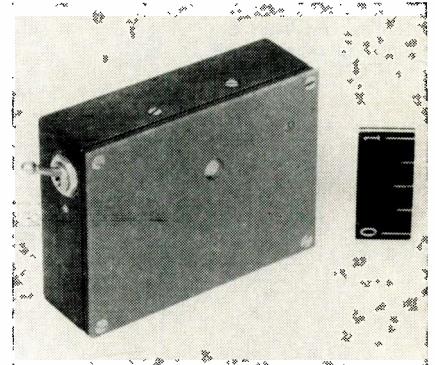

Fig. 2 (left): Wiring diagram of wireless mike shows the general layout of parts.

the emitter circuit of either audio stage.

Total current drain is approximately 3.8 ma. All measurements were made with a VTVM. Ac and dc measured voltage readings are shown in Fig. 1. The unit is powered by a 9-volt mercury transistor battery.

The circuitry and battery are housed in a specially fabricated phenolic case that measures $2\frac{3}{8} \times 1\frac{3}{4} \times \frac{3}{4}$ in. It is designed for easy replacement of the battery and maximum protection to the circuitry. Adjustment of the tank capacitor is made by inserting a screwdriver into slot provided on the cover plate. The tank capacitor is mounted in the case such that the slotted shaft extends into the cover plate. The microphone should be mounted within a shock absorbent material, preferably of resilient foam plastic.

Layout of the components is shown in Fig. 2. Layout is not critical and may be altered to satisfy any desired arrangement. It is advisable, though, to keep all leads as short as possible, especially in the oscillator section.

Circuit Modifications

Other transistor types to replace the Western Electric type 2N537

Fig. 4: Unit is shown with the cover removed. Note the parts layout.

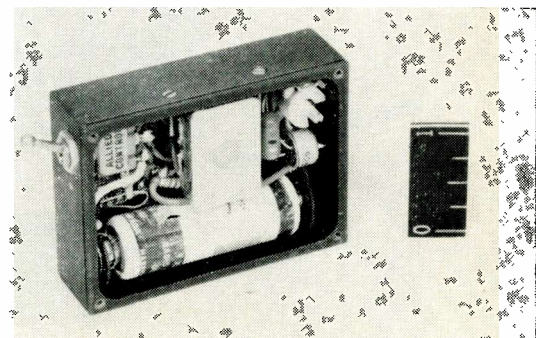

increases and decreases at the modulating rate which causes the collector-to-base voltage to also increase and decrease at the modulating rate. This change in collector-to-base voltage varies the capacity existing between the collector and the base. The capacity is due to a space charge region existing at the junction of the collector and base. As the collector-to-base voltage increases, the space charge region increases and effectively decreases the capacitance. As the collector-to-base voltage decreases, the space charge region decreases and effectively increases the collector capacity. This in effect is similar to squeezing together or spreading apart the plates of a parallel capacitor. As the collector output capacitance decreases, the resonant frequency of the oscillator tank circuit increases and vice versa.

The resonant frequency of the oscillator tank circuit is therefore increasing and decreasing at the modulating rate. The output of the oscillator is then a frequency modulated tank capacitor was chosen as an optimum value to stabilize frequency deviation, as well as its ability to tune the FM band. Since the collector-to-base capacity and the tank capacitor are effectively in parallel, the value of the tank capacitor is selected so that it is not too small or too large.

If the tank capacitor is too small, the collector-to-base capacity will become an appreciable part of the oscillator tank circuit causing an excessive amount of frequency deviation. Likewise, if the tank ca-

pacitor is too large the collector-to-base capacity will become an insignificant part of the oscillator tank circuit, causing a reduced amount of frequency deviation.

Therefore, it can be seen that the amount of frequency deviation can be controlled by the size of the tank capacitor as well as the amount of audio signal applied to the oscillator. The frequency deviation is approximately 200 kc.

Tuning Adjustment

For accurate tuning adjustment, the resonant frequency of the oscillator should be checked with the battery connected in the circuit. If the tuned circuit is adjusted without the battery connected, the resonant frequency of the oscillator will be higher in frequency than with the battery is connected. The shift in frequency is caused by the absence of dc bias on the base of the oscillator.

A feedback capacitor of 2 μ fd was selected as the minimum value to sustain reliable oscillation consistent with overall maximum efficiency. The oscillator is biased with 0.52 v dc through a voltage divider consisting of a 10k and 1k resistor. The 2N104 is biased in a similar manner at the junction of the 82K and a 15K resistors to provide a bias of 0.35 v dc. The gain of the amplifier is fixed to provide microphone pick-up of intelligible sound from a distance slightly greater than that which can be heard by ear. The gain can be decreased if desired by decreasing the value of the by-pass capacitor in

Fig. 5 : An alternate FM wireless mike circuit is shown using 2N207B transistors.

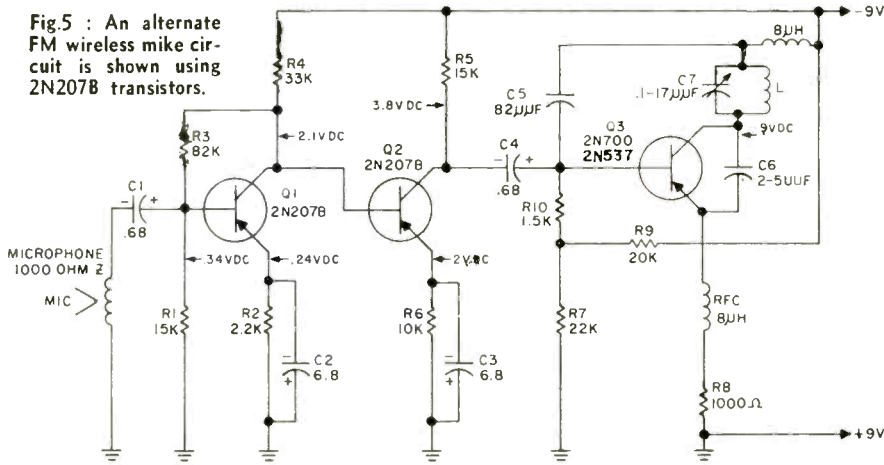

NOTE:
1. ALL CAPACITORS IN UF UNLESS MARKED OTHERWISE.
2. ALL MEASUREMENTS MADE WITH VTVM.

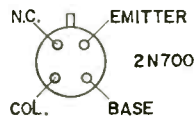

Wireless Mike (Continued)

may be used. The use of certain transistors may call for a slight alteration in bias to assure that the transistor is working under the proper conditions.

An alternate circuit (slightly modified) using a 2N700 or 2N537 for the oscillator is shown in Fig. 5. The 2N700 (as used here) may be considered as a direct replacement for the 2N537. The oscillator current may be adjusted by the value of the feedback capacitor C6 shown in Fig. 5. The collector current can be adjusted to 3 ma. with a feedback capacitance value of 2 µµf and 5 ma. with a capacitance value of 5 µµf.

Care should be exercised not to run the collector current so high as to exceed the transistors maximum power dissipation of 75 milliwatts. It is best to operate the transistor at a level of 50 mw. or less, this should provide a sufficient margin of safety.

Both circuits using the 2N537 and the 2N700 may be operated with a battery supply voltage as low as 3 volts where low power, small size and long battery life are prime requirements.

There are no restrictions to packaging, if the engineer wishes to alter the design and repackage the circuit to fit a configuration of his choice, except that a completely

(Continued on page 208)

Fig. 6: Photograph shows parts layout for circuit in Fig. 5 above.

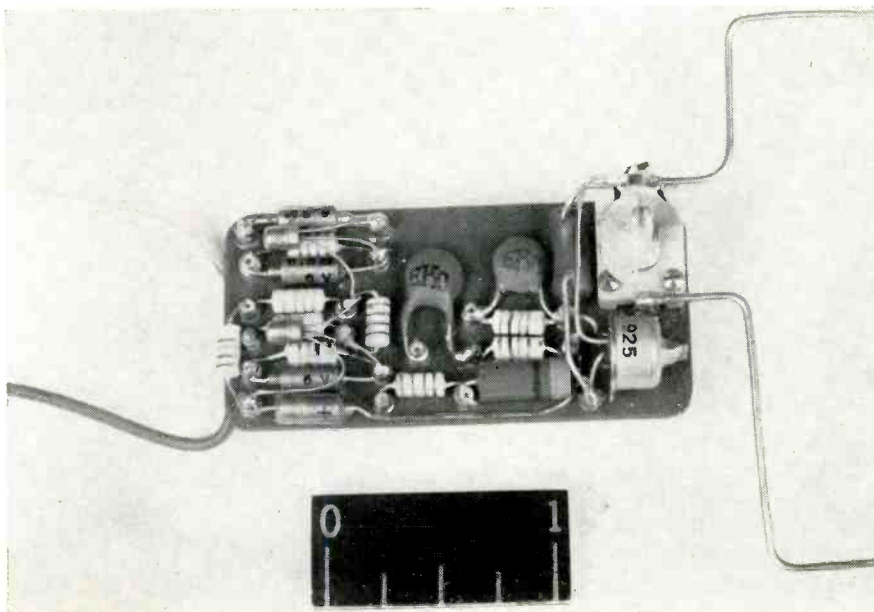

**Immediate
delivery!**

**HST
TRANSFORMERS**
IN QUANTITIES UP TO
250 per item
at factory prices!

CONTACT THESE AUTHORIZED
HST-ARCO INDUSTRIAL DISTRIBUTORS

ARIZONA

Radio Specialties & Appliance Corp.
917 N. 7th Street, Phoenix

CALIFORNIA

Brill Electronics
610 E. 10th Street, Oakland 6
Hollywood Radio & Electronics Inc.
5250 Hollywood Boulevard, Hollywood 27
Pacific Wholesale Co.
1850 Mission Street, San Francisco 3
Shanks & Wright Inc.
2045 Kettner Boulevard, San Diego 1
Shelley Radio Co. Inc.
2008 Westwood Boulevard, Los Angeles 25
R. V. Weatherford Co.
6921 San Fernando Road, Glendale 1

COLORADO

Denver Electronics Supply Co.
1254 Arapahoe Street, Denver 4

MARYLAND

Kann-Ellert Electronics, Inc.
2050 Rock Rose Avenue, Baltimore

MASSACHUSETTS

Lafayette Radio Corp.
110 Federal Street, Boston 10

NEW JERSEY

Federated Purchaser Inc.
1021 U.S. Route 22, Mountainside

NEW YORK

Arrow Electronics Inc.
525 Jericho Turnpike, Mineola, L. I.
Harvey Radio Co., Inc.
103 W. 43rd Street, New York 36
Lafayette Radio Electronics Corp.
100 Sixth Avenue, New York 13
Terminal-Hudson Electronics Inc.
236 W. 17th Street, New York 17

TEXAS

All-State Electronics Inc.
2411 Ross Avenue Dallas 1
Busacker Electronic Equipment Co. Inc.
1216 W. Clay, Houston 19
Engineering Supply Co.
6000 Denton Drive, Dallas 35

UTAH

Carter Supply Co.
3214 Washington Boulevard, Ogden

WASHINGTON

C & G Radio Supply Co.
2221 Third Avenue, Seattle

CANADA

Electro Sonic Supply Co. Ltd.
543 Yonge Street, Toronto 5, Ontario

ARCO ELECTRONICS, INC.
NEW YORK • DALLAS • LOS ANGELES
Exclusive Supplier of HST Transformers to
Distributors and Jobbers in U.S.A. and Canada

Circle 158 on Inquiry Card

HST* TRANSFORMERS

Type SMH

Ultimate in space and weight saving. Hermetically sealed to meet MIL-T-27A specifications. Frequency range 30-10,000 cps maximum levels to 30 mw. Designed to meet the most stringent applications.

Type TA

Encased in special material formed into rugged deep drawn cases that afford maximum magnetic shielding. Excellent fidelity for levels to 10 mw. Wide frequency range is consistently achieved. Meet all MIL-T-27A specifications.

Type MH

Designed to meet MIL-T-27A specifications for speech circuit applications including transistorized optimum response from low to high frequency. Maximum power ranges to 100 mw. Hermetically sealed.

Type SMD

SMD open construction affords maximum flexibility in both electrical and mechanical considerations. Though subminiaturized these units exhibit unusually high efficiency and wide frequency response. New design leads to greater dependability and higher performance.

Type SMH

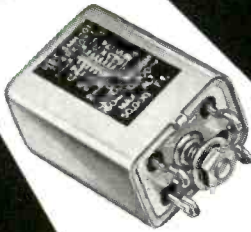

Type MH

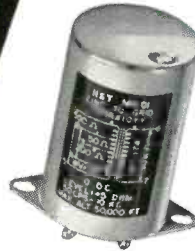

Type SMD

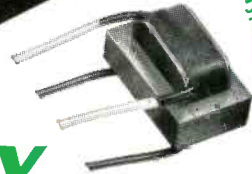

**24 Hour Delivery
from ARCO**

Type TAF

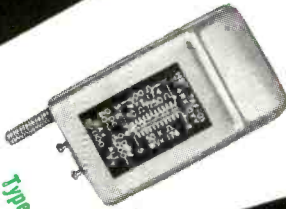

Type TT



Type SS



Type SSM



Type SS

Fills need for an economical, compact, quality transformer. Weighs one ounce yet is fully impregnated and sealed in a drawn aluminum case. Ideal for portable broadcast, aircraft, mobile service, etc. High fidelity characteristics are provided, uniform within approximately 1 db from 30 to 20,000 cycles.

Type SSM

This popular series is designed to handle higher levels than the SMD units yet, retain the high performance characteristics exhibited by that series. Available as a hermetically sealed unit (encasement is identical to the SMH series).

Type TT

Built and tested to meet MIL-T-27A specifications, for altitudes up to 50,000 ft. Ideally suited for transistor circuits. In addition, frequency response ratings are based on military specifications. The exceptional reliability and low distortion characteristics combine for excellent performance.

Complete stocks are available from ALL Arco branches or from any Arco-HST Industrial Distributor for instant shipment upon receipt of order. Required material is prepared minutes after your request is received. Arco's branches in Dallas and Los Angeles, eliminate any delay in shipping time from the East to West coast.

ARCO electronics inc. *Transformer Division,*
Community Drive, Great Neck, New York • HUnter 7-0500

BRANCHES:

LOS ANGELES
ARCO CAPACITORS INC.
1543 So. Robertson Blvd., Los Angeles 35, Calif.
CRestview 1-1151

DALLAS
ARCO ELECTRONICS INC.
1339 Crampton St., Dallas 7, Texas
Riverside 8-0648

Manufactured by



* Dresser Electronics
HST Division

ACME ELECTRIC TRANSFORMERS ARE

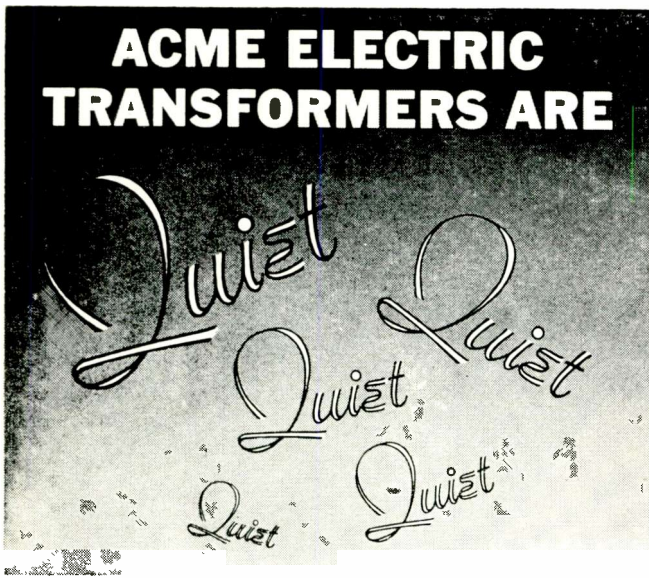

While sound levels vary with every transformer installation due to background noises, acoustics of the room and even resonance of a mounting platform, wall or mounting column, there is one thing of which you can be sure. EACH Acme Electric dry type transformer has been basically designed, carefully constructed and processed so that the maximum average sound level is well below the sound level standards accepted by the industry.

TRANSFORMER INDUSTRY ACCEPTED SOUND LEVEL STANDARDS		
Transformer Rating KVA	Average Sound Levels Decibels	Acme Dry Type Average Sound Level in Decibels
0 to 9	40	38.7
10 to 50	45	42.5
51 to 150	50	47.8
151 - 300	55	53.9
301 - 500	60	59.1

If you want QUIET transformers, specify Acme Electric—no hum, no buzz.

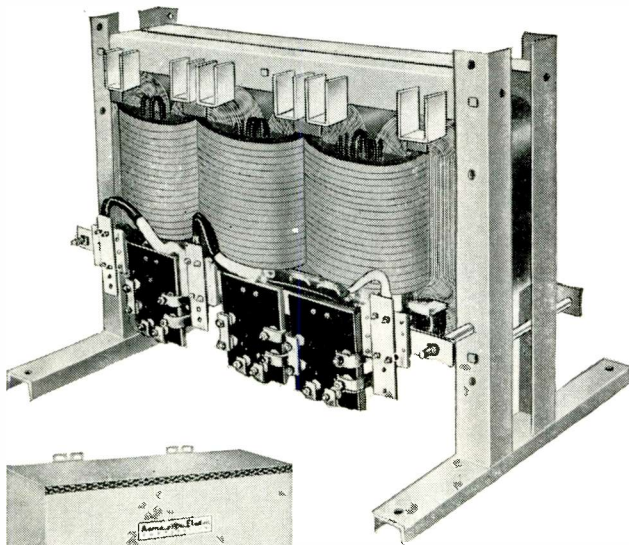

CUSTOM DESIGNED & BUILT
240 KVA 3 phase 60 cycles
Primary 410 volts with $\pm 2\frac{1}{2}\%$ taps
Secondary 162 volts

ACME ELECTRIC CORPORATION

892 Water St.

Cuba, N. Y.

In Canada: Acme Electric Corp. Ltd., 50 Northline Rd., Toronto, Ont.

SAA 3427/1879

Acme  **Electric**
TRANSFORMERS

CUES

for Broadcasters

Bulletin Alarm System

Donald M. Wheatley, Ch. Eng.

WJOY, S. Burlington, Vt.

In this area when news is very important to a radio station, we have found that a news bulletin alarm system has put us on top many times. This circuit originally came to us from the ABC network and with a few modifications it has certainly been worth the slight cost.

The original circuit called for the alarm to trip if 5 or more bells were rung on the news machine. We have changed it so that just the 5 bells will trip the alarm.

We did not want to have to hire a city licensed electrician to run the light leads to the control room so we stepped the voltage down to 6 volts—then came

Only 5 bells will trip the bulletin alarm system shown.

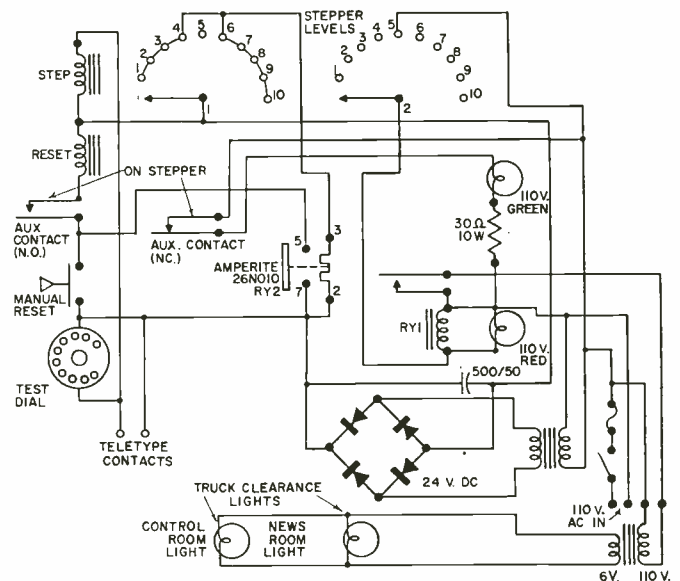

the problem of what to use for lights that would show up well. Finally the idea of truck clearance lights came up. They are inexpensive and just the thing. In the control room we have a dual orange and red one that is mounted so that it can also be seen from the studio. In the front office over the news room door we have a fancier flush mounted type.

Many times we have had the bulletin on the air for ten minutes or more before the network broke in to give the news. And when we are waiting for the bulletin to come over we do not even have to stick in the news room.

\$\$\$ for Your Ideas

Readers are invited to contribute their own suggestions which should be short and include photographs or rough sketches. Typewritten, double spaced text is requested. Our usual rate will be paid for material used.

NYLON TIP JACK
Available in all nylon body or as a metal-clad type to meet military specifications. Completely insulated—no auxiliary mounting hardware needed.

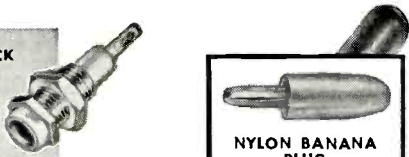

NYLON BANANA PLUG
A rugged, high voltage insulated plug for a wide variety of applications.

NYLON BANANA JACK
Molded nylon body provides voltage breakdown of 12,500 volts DC.

NYLON BINDING POST
Compact, completely insulated, pre-assembled 6-way binding post.

NYLON TIP PLUG
Designed for solderless connection—fits all standard tip jacks.

NYLON CONNECTORS

Voltage breakdowns up to 12,500 volts DC!

These rugged Johnson connectors are molded of tough, low-loss shock-proof nylon—and will not chip or crack, even when subjected to extreme temperature changes or severe mechanical stress. Nylon provides high voltage insulation, with voltage breakdowns up to 12,500 volts DC. Metal clad tip jack meets MIL specifications (full specifications available on request). All connectors are designed for fast, easy mounting—and are available in 13 bright colors for coded applications.

OTHER CONNECTORS—Johnson also manufactures a complete line of standard connectors in addition to the nylon line described above. For complete information, write for our newest components catalog shown below.



NEW

DUAL BANANA PLUG
Extremely versatile—provides variety of application possibilities. Solderless design—tough shock resistant nylon body retains strength and low-loss characteristics over a wide range of temperature and high relative humidity conditions. Available in 13 permanent colors.

New Catalog

Write today for our newest electronic components catalog—complete specifications, engineering prints and current prices on:

- CAPACITORS • TUBE SOCKETS • CONNECTORS • PILOT LIGHTS
- INSULATORS • KNOBS, DIALS • INDUCTORS • HARDWARE



8 MAJOR COMPONENT LINES



E. F. JOHNSON CO.

2016 Second Avenue S.W. • Waseca, Minnesota

Circle 279 on Inquiry Card

ELECTRONIC INDUSTRIES • February 1961

35,000 SMASHING, BATTERING IMPACTS— and still working perfectly!



NEW

SHURE "TEN-FOUR" COMMUNICATIONS MICROPHONE

proves its incredible durability in this gruelling destruction test!

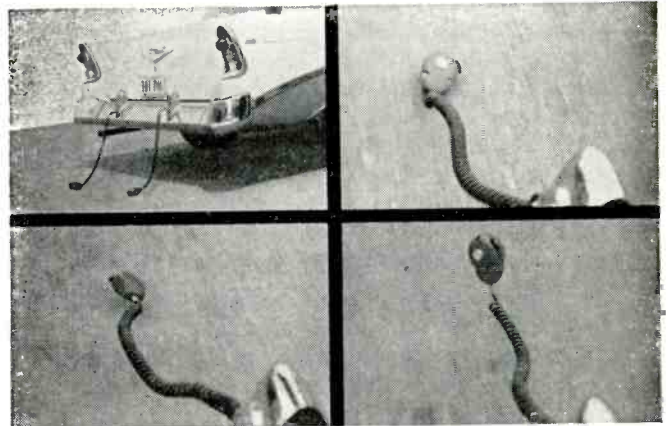

New SHURE "TEN-FOUR" MICROPHONE, with exclusive Armo-Dur housing, and another microphone with standard die-cast metal housing were dragged for miles on a test drive over all kinds of pavements at speeds to 30 mph. In a matter of minutes, it was subjected to greater punishment than a lifetime of severest mishandling and here's the result:



Ten-Four with Armo-Dur Housing virtually unmarked—still performed perfectly!

Standard microphone with die-cast metal housing—cracked, broken, abraded—microphone inoperable.

For the microphone that stands up under severe operating conditions with no loss of high speech intelligibility, be sure to specify the Shure "Ten-Four" when you order your new communications equipment or replacements.

(Can be furnished with "Controlled Magnetic" or carbon cartridge.)

SHURE BROTHERS, INCORPORATED
222 Hartrey Avenue, Evanston, Illinois
HIGHEST QUALITY MICROPHONES—FIXED-STATION AND MOBILE
Circle 40 on Inquiry Card

WASHINGTON

News Letter

NEW FCC CHAIRMAN—Newton W. Ninow, law partner of Adlai E. Stevenson and administrative assistant to the latter when he was Governor of Illinois, is President Kennedy's selection to head the FCC. He succeeds Frederick W. Ford, who was Chairman of the Commission during the latter part of the Eisenhower Administration. Mr. Ford remains as a member of the Commission.

WHITE HOUSE OFFICE—An Office for the Coordination and Development of Communications Policy has been created within the White House organization. Transfer by executive order of the powers of the Office of Civil & Defense Mobilization in the telecommunications and broadcasting fields to the new White House entity has been recommended by James M. Landis to Pres. Kennedy in his report on the federal regulatory agencies. Dean Landis, Securities & Exchange Commission and Civil Aeronautics Board Chairman during Pres. Roosevelt's administrations, has been named as Pres. Kennedy's temporary special assistant to overhaul the regulatory agencies, including the FCC. The new White House Office for Communications Policy recalls that Pres. Truman's communications policy adviser was Haraden Pratt, outstanding radio-electronics engineer (presently Secretary of the IRE).

ALLOCATIONS COORDINATION—The Landis report says that effective inter-agency action is lacking in spectrum allocations in keeping pace with present developments in communications and electronics. This includes jet aviation traffic control, intercontinental rockets, space communications, and radio astronomy. Dean Landis emphasized that closely coordinated broad national policies must be developed between the "many agencies" concerned with allocations. These include the FCC, State Department, National Aeronautics & Space Administration, the Interdepartmental Radio Advisory Committee, Army, Navy, Air Force, and the Federal Aviation Administration.

POSSIBLE CLASH WITH CONGRESS—The Landis report's recommendations on the reorganization of the regulatory agencies contained several proposals that might arouse controversy in Congress. Federal commissions, such as the FCC, are regarded by Congress as being under its jurisdictional control. Key members of Congress, both Democrats and Republicans, stressed that Congress would not be willing to let the White House tighten its grip on the regulatory agencies. The Landis report, however, met approval from all sides that the Commissioners and their technical staffs should be highly qualified so as to improve policy making and procedures.

INFLUENCE IMPACT—The FCC was charged in the Landis report with being too "subservient" to the communications subcommittees of Congress. Also, with being under the "influence" of commercial interests, particularly the broadcasting networks. "No patent solution for this situation exists," the report stated, "other than the inclusion of vigor and courage within the Commission by giving it strong and competent leadership, and thereby evolving sensible procedures for the disposition of its business." One of the first jobs for the Kennedy administration should be to overhaul the FCC in a reorganization plan. Mr. Landis proposed that President Kennedy should submit such a plan to Congress.

SPACE-EARTH SHARING—The FCC has added to its long-range inquiry into space communications subjects because of "recent developments." One revised, and one additional issue. Subjects relate to the sharing of frequency bands by space communications operations and earth systems. The revised issue seeks more clearly delineated data on earth-space sharing. The new issue is on the selection of earth terminal sites. However, the FCC emphasized that "it does not deem itself, precluded during the pendency of this proceeding, from undertaking or authorizing such research activities and functions, with respect to space communications, as it deemed appropriate." The American Telephone & Telegraph Co. has before the Commission a proposal for a trial of commercial space communications, using an active satellite system. The FCC is to receive comments on its long-range inquiry in this field by March 1.

*National Press Building
Washington 4*

ROLAND C. DAVIES

MILITARY PROCUREMENT & SMALL BUSINESS

—Small Business Committee's Subcommittee on Government Procurement is releasing a sharply critical report on "The Lack of Competition in Military Procurement and Its Impact on Small Business." The report says that non-competitive buying each year deprives unfairly the Nation's qualified small concerns of millions of dollars worth of prime contracts and adds unnecessary costs to our defense program. Main thrust of the report is against unnecessary negotiated and sole source awards. It cites statistics to show that military departments (in 1960) advertised contracts with a value of \$3.2 billion and negotiated contracts worth \$18.9 billion. Of those negotiated, 12.6% were awarded on the basis of price competition and 67.3% were negotiated with only a single supplier. The Committee urged "the military to exert greater efforts to obtain competition in the purchase of spare parts."

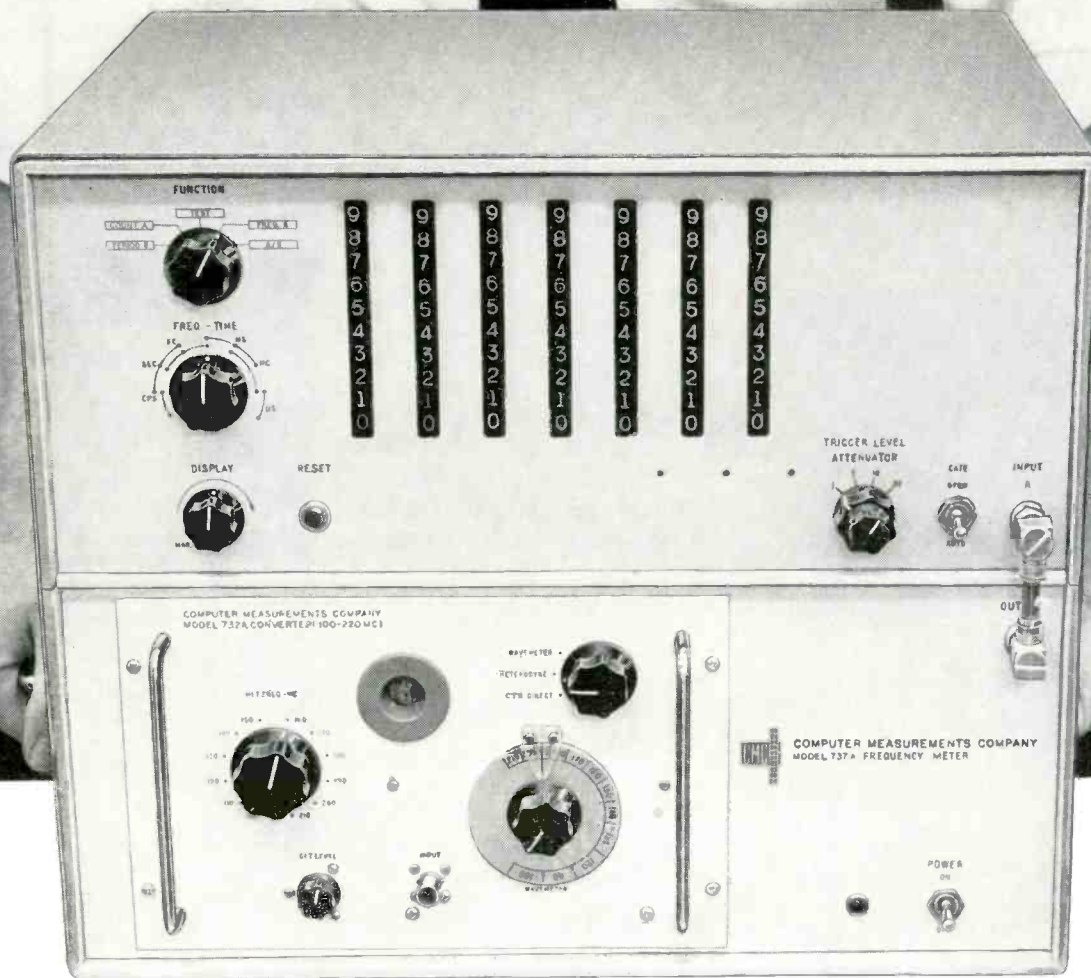

Model 737A shown with Model 732A Converter Plug-In

- > Measure frequency dc to 220 mc
- > Measure period to 0.1 microsecond
- > Measure time interval 0.1 microsecond to 10^7 seconds
- > Count dc to 10 mc

CMC, first with solid state reliability, announces the transistorized Model 737A frequency-period meter.

Here, combined in one compact package weighing a scant 53 pounds, are the functions of a high speed counter, frequency meter, and period meter. Sensibly priced at \$2400, the Model 737A mates an all solid state counter with a plug-in vacuum tube heterodyne converter.

Only 14" high, 17" wide, and 13" deep, CMC's new Model 737A requires a mere 125 watts of power which in itself reduces operating temperatures and contributes to long trouble-free life. And except for the vacuum tubes, the new unit is unconditionally guaranteed for two years.

**NEW
TECHNICAL
BULLETIN
TELLS ALL**

Your nearby CMC engineering representative will be happy to provide you with full technical, sales, and delivery information and arrange a demonstration at your convenience. For a free copy of our new technical bulletin, please address Dept 44.

THREE PLUG-INS AVAILABLE

1. 10 mc to 100 mc frequency converter; 2. 100 mc to 220 mc frequency converter; 3. Solid state 0.1 microsecond to 10^7 second time interval section.

Converter plug-ins \$250 each. Time interval plug-in \$300.

FEATURES AND ADVANTAGES * Decade count down time base, frequency divider circuits never need adjustment. * Automatic decimal point. * Nixie readout available as standard option. * Stability, 2 parts in 10^7 standard, 5 parts in 10^8 special. * Accuracy, ± 1 count \pm oscillator stability. * Sensitivity, 0.25 v rms. * Standardize against WWV. * Remote programming without special regard to cable length, type of cable, or impedance matching. * Printer output to drive digital recording equipment, punches, inline readout and other data handling gear, \$80 extra.

Circle 41 on Inquiry Card



36



**Computer
Measurements Co.**

A Division of Pacific Industries

12970 Bradley Avenue, Sylmar, California
Phone: EMpire 7-2161

ROHN COMMUNICATION TOWER

No. 60

for height up to
490 feet!

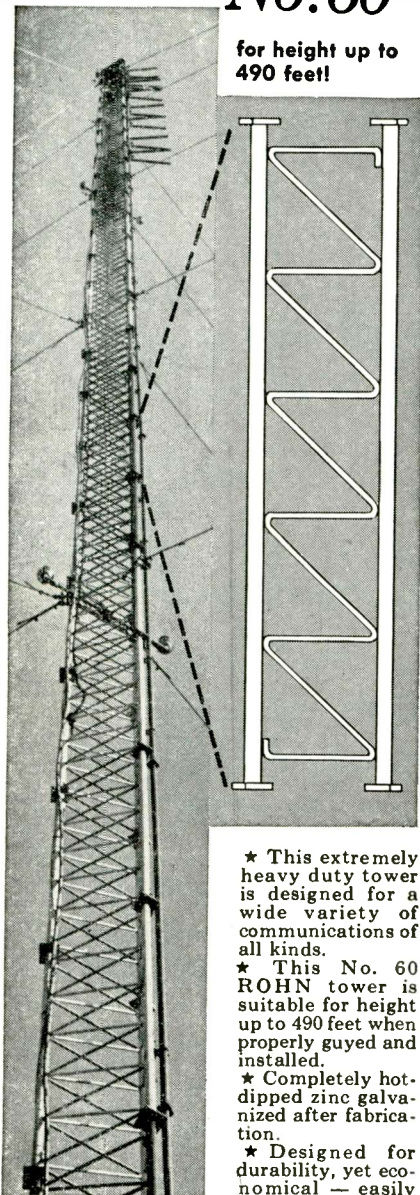

Shown above is a ROHN No. 60G tower used for FM broadcasting, installed to a height of 300 feet.

★ This extremely heavy duty tower is designed for a wide variety of communications of all kinds.

★ This No. 60 ROHN tower is suitable for height up to 490 feet when properly guyed and installed.

★ Completely hot-dipped zinc galvanized after fabrication.

★ Designed for durability, yet economical — easily erected and shipped. ROHN towers have excellent workmanship, construction and design. Each section is 10 feet in length.

FREE

Details and complete engineering specifications gladly sent on request. Also ROHN representatives are coast-to-coast to assist you.

Write-Phone-Wire Today!

ROHN Manufacturing Co.

Box 2000
Peoria, Illinois
Phone 637-8416

"Pioneer Manufacturers of
Towers of All Kinds"

Circle 42 on Inquiry Card

Wireless Mike (Concluded)

non-metallic case should be used. The engineer may choose to explore the use of larger diameter wire or possibly use strip copper foil for the loop. The circuit values are not so critical as to impose restrictions. Any reasonable modification or additional sophistication that may be desired is left to the designer's imagination.

Acknowledgment is made to Messrs. Joseph F. Curran and Russell F. Schmidt of the United States Army Signal Research and Development Laboratory for their contribution to the development of the FM Wireless Microphone.

PARTS LIST

- C1, C4—.68 μ f fixed tantalitic capacitor 20v.
- C2, C3—6.8 μ f fixed tantalitic capacitor 6v.
- C5, C6—.001 μ f fixed low voltage ceramic.
- C7—1-17 μ f variable air trimmer (Radio Condenser Co. series 75 for printed circuits).
- C8—2 μ f fixed low voltage ceramic.
- L—One turn loop around case, #22 enamel wire (see text).
- R1, R5—15K.
- R2—2.2K.
- R3—82K.
- R4—33K.
- R6, R9—10K.
- R7—1K.
- R8—200 ohms.
- RFC—8 μ h (Jeffers).
- Q1—2N104 transistor (RCA) or 2N-207B (Philco).
- Q2—2N105 transistor (RCA) or 2N-207B (Philco).
- Q3—2N537 transistor (WE) or 2N-700 (Motorola).
- Mic.—1000 ohm microphone (Shure MC-20J)
- Misc.—Switch, the posts, hardware, etc.
- Battery—9 volt (RCA type VS309A).

1. Ed. Note: See Part 15 of FCC's rules and regulations. We have abstracted one paragraph of this section here.

§ 15.206 Operation Above 70 Mc.

A low power communication device may be operated on any frequency above 70 Mc, provided it complies with all of the following conditions:

(a) Operation is limited to one second duration and to occur not more than once in 30 seconds.

(b) The radiated field on any frequency from 70 Mc to 1000 Mc does not exceed the limits specified for receivers in § 15.62 (50 μ v/m at 100 ft. for FM band).

(c) The radiated field of any frequency above 1000 Mc does not exceed 500 microvolts per meter at a distance of 100 feet.

(d) The device is provided with means for automatically limiting operation within the time restrictions specified in this section.

NEW

- Direct Reading In Degrees.
- Accuracy 0.05° or 1%.



PHASEMETERS

Type 405 Series:

1 cps to 500 kc. Accuracy 0.25° relative, 1° absolute. No amplitude adjustment from 0.1v to 70v. Suitable for plotting phase curve.

Type 202: 20 cps to 500 kc. Accuracy 0.02° or 2%. 1° full scale sensitivity. Phase range 0-1, 0-2, 0-4, 0-12, 0-120 and 0-180 degrees.

Type 205A1-A2: 100 kc to 15 mc. Accuracy 0.05° or 1%. Sensitivity 0.04v.

Type 205B1-B2-B3: 15 mc to 1500 mc. Accuracy 0.05° or 1%. Sensitivity down to 20 microvolts with receiver.

AD-YU

ELECTRONICS LAB, INC.
249 TERHUNE AVENUE
PASSAIC, NEW JERSEY

Circle 43 on Inquiry Card



Antenna Systems, Inc., is devoted exclusively to the design, fabrication and installation of antenna systems in the fields of scatter communications, missile tracking, space tracking, radar and surveillance, radio astronomy, and special antenna products.

We invite your inquiry, whatever your antenna problem may be. Write for our folder.



ANTENNA SYSTEMS INC.
HINGHAM, MASS.

Circle 44 on Inquiry Card

Radiosonde

(Continued from page 127)

ancing potentiometer - type strip-chart recorder.

Performance

The sensitivity of the receiver, as measured at the output of the discriminator is less than $2 \mu\text{v}$ for 30 db quieting. Overall selectivity is down 15 db ± 2 db at 200 KC and pass-band width is ± 100 KC at -3 db. Overall gain of the i-f is 65 db.

D3 output voltage from the frequency converter is linearly proportional with 0.1% of full scale (200 CPS) to the input pulse frequency.

With constant repetition rate pulse input, the output is constant within 0.05% of full scale when the pulse amplitude is varied from 7 to 35 v peak to peak. Output is also constant within 0.05% with variations of input wave shapes from sawtooth, sinewave, and rectified sinewaves.

Author gratefully acknowledges the assistance and creative contributions of J. Ash and J. Blickfeld.

References

1. England, J. W., Thanos, H., "Application of Drift Transistors to F. M. Receivers," *IRE Transactions on Broadcast and Television Receivers*, Jan. 1959.

Transistors

(Continued from page 101)

from crystals about .002 in. thick. The junction is built in by exposing the material to vaporized aluminum at 3900° . The aluminum atoms diffuse into the silicon carbide crystal, changing it from n-type to p-type. The junction is formed where the two types meet. The process is controlled to an accuracy of a few millionths of an inch.

To establish input and output terminals, the wafer is etched at two points so that the silicon carbide is eaten away until the junction within the body of the crystal is reached. Electrical connections are made at these two points and to the body of the wafer.

A typical finished transistor is about 0.080 in. long and 0.040 in. wide. Electrical measurements on the finished transistors show them to give a power gain of about 60 at room temperatures.



Old Fashioned?

See what **Ungar** does to soldering tools next month!

Large-size Steam Hammer • B. & S. Massey
Manchester, England • Circa 1885

Circle 45 on Inquiry Card

For that  **NEW IDEA**
visit the
IRE SHOW

March 20-23, 1961

New York

Coliseum and Waldorf-Astoria Hotel

Members \$1.00, Non-members \$3.00

Age limit—over 18

BUT, OUR PENDULUMS AREN'T SIMPLE, SIGNOR GALILEO!

Since your time, Schuler has shown that a simple pendulum can be used for navigation here on Earth if it has a period of 84.4 minutes. By your formula, Signor, the pendulum would be 3,959 miles long! We couldn't keep it simple; we had to mechanize an artificial pendulum with Schuler's long period to inertially guide the Mace missile. If you, as an engineer, would like to join us in compounding such new approaches from traditional science, and if you have a BS, MS or PhD in Physics, ME, EE, or Math, please contact Mr. E. J. Allen, Director of Scientific and Professional Employment, 7929 S. Howell, Milwaukee 1, Wisconsin.

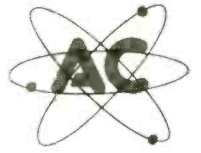

AC SPARK PLUG ✻ THE ELECTRONICS DIVISION OF GENERAL MOTORS



PROFESSIONAL OPPORTUNITIES

Reporting late developments affecting the employment picture in the Electronic Industries

Design Engineers • Development Engineers • Administrative Engineers • Engineering Writers
Physicists • Mathematicians • Electronic Instructors • Field Engineers • Production Engineers

EIA Booklet "Pushes" U. S. Electronic Industry

The Tube and Semiconductor Division, Electronic Industries Association, has prepared a new booklet explaining why "it pays to do business with U. S. electronics manufacturers."

It is part of EIA's campaign to counter electronic imports from low-wage foreign producers, which in the case of the Japanese, have increased 240 times in the last five years.

Entitled "Plus Values" the booklet highlights these advantages of buying U. S.-made tubes and semiconductors: freedom from uncertainties of overseas transportation, ready availability of manufacturer inventories which make it unnecessary for distributors to tie up capital in large stocks, and engineering and laboratory services. Also featured are the economic benefits of a healthy U. S. tube and semiconductor industry.

"Planning Vital"—Slocum

Effective long-range planning in the electronics industry "has never been more vital than it is today," says Walter W. Slocum, President of International Resistance Co., Phila., Pa. "Broader depth planning is necessary," he declared, "to offset the high cost of mistakes in today's business climate and to meet the challenge of global economic warfare."

He emphasizes the importance of such factors as changes in economic cycle, research and development efforts, preparation of marketing plans for commercializing new products, provision of capital for plant and process requirements, and budgeting for profits. Mr. Slocum discussed this increasing emphasis on advance planning at the 14th Annual Forecasting Conference sponsored by the Chamber of Commerce of Greater Philadelphia.

MASTER COMPUTER

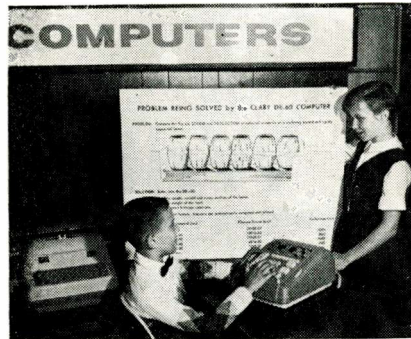

Eleven-year-olds, Kathleen Woodruff and Victor Morton, operate a Clary DE-60 Computer. Sixth-graders are doing a problem in computing stress and deflection. They mastered the general-purpose computer in 14 hours.

Powder Metallurgists Organize in New York

A new national organization for powder metallurgists, the American Powder Metallurgy Institute, has established a Section of the Institute in the New York metropolitan area for engineers, metallurgists, and others interested in powder metallurgy.

Engineers interested in participating in New York Section activities should contact either the Chairman, John K. Shaw, S-K-C Research Associates, 445 Fifth Ave., Paterson, N. J. or the Institute's Executive Secretary, Kempton H. Roll, at 60 East 42nd St., N. Y. 17, N. Y. Dues are \$15 the first year and \$10 thereafter.

Retiring?

The U. S. Chamber of Commerce feels that those in the 30-to-50 age bracket are not too young to start planning for retirement. They have prepared a booklet, "Look Forward to Your Retirement," which tells you what to do—and what to avoid—in drafting a blueprint for your old age. It will also help you advise your employees seeking guidance on the subject.

Single copies are free. Write to: Chamber of Commerce of the United States, 1615 H Street, N. W., Washington 6, D. C.

Engineering Degrees Off, First Drop Since 1944

The number of Bachelor Degrees granted in engineering will be approximately 2.5% less in 1960 than in the previous year. An Office of Education survey indicates the Bachelor's Degrees will total between 37,000 and 37,500. There were 38,134 engineering degrees granted last year.

An unhealthy trend is developing. The decline in undergraduate engineering enrollment from 1958 to 1959 was greater than in the preceding year. This means that the drop in Bachelor's degrees may be even sharper in 1960-61.

The losses may be offset by increases in the number of students graduating in mathematics, or in physical science fields closely related to engineering. There was, for instance, an increase of 17.6% in Junior's majorings in mathematics from the fall of '58 to fall of '59.

Long Island Gets New Graduate School

The Polytechnic Institute of Brooklyn is building Long Island's first graduate school of engineering. The facility, with research labs, is being built on 25 acres of land donated by Republic Aviation Corp., on Route 110 a half mile east of the Nassau-Suffolk border.

Graduate work will be offered (day and evening—full or part-time) in aero-space engineering, electrical engineering, mechanical engineering, mathematics, and physics. There will be 3 labs for basic research in aerodynamics and in high power electronics. Classes are scheduled for the fall 1961 semester.

FOR MORE INFORMATION . . . on positions described in this section fill out the convenient inquiry card, page 155.

A REPRINT

of this article can be obtained by writing on company letterhead to

The Editor

ELECTRONIC INDUSTRIES
Chestnut & 56th Sts., Phila. 39, Pa.

By A. M. MORGAN

Systems Design Engineer

General Electric Co.

Heavy Military Electronics Dept.

Court St.,

Syracuse, N. Y.

Writing — Key to

THE ultimate success of an engineer—like that of most other professional people — depends to a large extent on the ability to communicate his knowledge to other people. This important fact has been overlooked too long. It is becoming increasingly important as our world becomes more complex.

Knowledge, in itself, is of little value until it can be communicated. The most gifted engineer, if unable to speak or write effectively, is as useful as an automobile with no gas; neither can be utilized, nor evaluated on performance. It is no coincidence that the most successful engineers are also most proficient at speaking, or writing—or both.

Such an ability demonstrates an individual's thought pattern and organization, imagination, knowledge and grasp of the subject matter, sense in determining important factors. Of all the qualities an engineer must possess to achieve success, his ability to "communicate" effectively heads the list.

While very often mistaken for an end-product in itself; knowledge in reality, is merely a milestone to personal development.

Upon attaining the level of technical knowledge necessary in his profession, the engineer's first step in personal development is learning how to express his knowledge, ideas, and opinions by means of

the written word.

Almost every professional engineer today, from research to production, must write letters, reports, papers, or memoranda; good writing distinguishes the capable individual.

What Constitutes a Well Written Text?

The first prerequisite in writing is a knowledge of grammar and, secondly, a good vocabulary. "Increase your word-power" has very real meaning to an engineer. Certainly there is a strong connection between knowledge and vocabulary. The well-written report not only is grammatically correct, but is also as interesting to read as the subject matter permits.

Writing, as a means of communicating information; should enable the reader to understand what the writer intended the text to convey. Having to read a sentence three or four times, in order to understand what the writer meant is a severe criticism of the writer. Is he a muddled thinker? Is he deliberately being vague? Perhaps he does not fully understand the subject or maybe he is just inefficient. Perhaps he just lacks the ability to express himself understandably in writing. The writer of letters, memoranda or reports would do well to remember this point.

The well-written text should flow

smoothly to hold the reader's attention. The English language embraces a wide choice of words suitable to meet any particular need; conveying various shades of meaning to suit a specific occasion. Sentences, too, constructed in various ways give the same meaning a different emphasis, or perhaps a subtle difference in meaning. These peculiarities of language, particularly of English, cause a writer, with practice, to develop a particular style. There is a world of difference between, for example, the styles of Emerson, Shaw, Hemingway, and O'Henry. The man who writes, be it fact or fiction, cannot avoid developing a style, if he writes often enough.

The well-written text not only provides information about the subject matter; but very often provides information about the writer as well. Good writing can, therefore help an engineer achieve success.

The badly written, and well-written, reports have one thing in common—they will be noticed.

The well-written text, from an engineering standpoint, is well described by the rule of the three C's. It should be Clear, Concise and Complete.

Communication

While communication represents one of the greatest problems of our

Of all the qualities an engineer must possess to achieve success, his ability to "communicate" heads the list.

The badly written, and the well-written, report have one thing in common—both will be noticed.

How your report is received is important to your advancement.

Your Engineering Development

age, it is certainly the largest unsolved problem in engineering. How many millions of dollars are wasted in the United States alone, for example, on reinvention, duplication of effort, and misunderstanding?

The engineer would do well to remember these problems of human communication in engineering. He should at least try to improve his own communication channels by learning to write and speak with acceptable proficiency.

The value of an engineer to an engineering company is therefore, just about equal to his ability to communicate.

Writing and Speaking

The written text has several advantages, and disadvantages, in comparison to the spoken word; a written book or report may be read, and digested, at a rate to suit the reader. He is also able to choose an environment that permits him to focus all his attention on the subject matter, and he may read it again and again — tomorrow, or next year.

The engineer who writes a letter, report, or book can never be certain of the number or type of people that may read his text. For unforeseen reasons, or even by accident, a copy of an engineer's letter or report might end up on a General Manager's or Chief Engineer's desk. It might even be read

in Washington, Moscow, London, Paris, and by top management in his company. Alternatively, he may publish a report and little more than the summary and conclusions may ever be read.

Undoubtedly, the written text has a far greater chance of being criticized than any verbal communication. It is also true that the written text has far greater potential than the spoken word, particularly in terms of publicity for the writer, good or bad.

The engineer who has something to say in writing, is advertising his capabilities to a potentially large number of people. His writing ability will undoubtedly influence the type of publicity he receives. Unlike the spoken word, it is on record for all time.

Personal Development

Writing can prove to be a very great aid to the personal development of an engineer. A hundred years ago, Lord Kelvin said that the best way to learn a subject was to write a book about it. Any engineer, who has ever tried to write a report, is well aware that, in the course of writing, some quite unforeseen gaps in his knowledge often come to light.

Writing is a method of expressing the creative ability of an individual. It also indicates a very strong connection between mental

awareness and the ability to express thoughts and ideas in words. Both of these mental processes, however, are capable of considerable development, given the opportunity; they are certainly subject to atrophy, if not used, however.

Apart from personal prestige awaiting the potential author of a good paper is the personal satisfaction derived from creative achievement. It also brings prestige to his department and his company.

Having learned the basic rules, the ability to write good prose requires practice—continual practice—until some degree of perfection is achieved. This, in itself, can be very rewarding to an individual. Even among the literary giants few achieve success in their early years.

The engineer, however, is not trying to become a literary genius; he is trying only to express himself in a coherent fashion. The engineer who combines knowledge with the ability to express himself in an acceptable manner has a very great potential. He is able to sell his ideas, affect policy, influence other people, and earn respect.

The Power of Argument

The classical meaning of the word "argument" is "a method of arriving at the truth by means of discussion"; unfortunately, it doesn't always turn out this way.

Writing . . . (Concluded)

Nothing can be more frustrating to an engineer than losing an argument, or failing to convince people during a discussion, when he possesses sufficient knowledge of a subject, or a situation, to know that the wrong decision has been made. Arguments are won by the people who can sell their ideas to others; those able to convert their opinions and thoughts into words. The most influential man is the one who is best able to convince other people—regardless of whether he is right or wrong. This type of situation can lead to very unfortunate consequences that are, in a company, apt to waste both time and money.

The engineer who fails to convince other people, because he lacks ability in the use of language, rather than knowledge, will receive very little sympathy even when he is in a position to say "I told you so."

Don't hesitate to disagree with your superiors, if you are convinced of your own arguments, but don't accept this advice if you lack the ability to convert your thoughts

into good, concise English. They will respect you for your opinions if you are able to present them in a convincing and acceptable manner—you may even establish a reputation if you are right 51% of the time!

Technical Knowledge

A technical knowledge of grammar, and the ability to convert bad English into good English, are both almost purely mechanical processes. In theory, we could design a machine which could convert bad grammar into good English. The machine could be programmed to sense the split infinitive, incorrect tense, spelling mistakes, incorrect punctuation, etc. But good technical knowledge of grammar does not imply any degree of creativity on the part of the writer.

An engineer is assumed to possess knowledge and a degree of creativity. In trying to write good English the engineer may utilize his knowledge, experience, and creativity to further advantage. It could even be argued that an

engineer must possess the ability to write and speak good English. It is certain that the more effective he becomes in presenting his knowledge and ideas, the greater his potential.

There is always the possibility that wasted money can be replaced, or further money borrowed. Wasted time, however, can not be recovered. The badly written memorandum or report on an important subject may be responsible for a very great deal of wasted time, as a result of misunderstanding of the text, or just plain reading difficulty resulting from poor English. The well-written report will not only add to the author's prestige; it may also save a great deal of time and money.

Finally, wisdom could be defined, with some measure of agreement, as "the ability to utilize knowledge and experience to optimum advantage." The person able to express himself in good English is taking a step in the right direction.

As an engineer, your future is in your own hands. You are judged largely by what you say and how you say it.

AIEE's Edison Medal To A.T.&T.'s Dr. Osborne

The Edison Medal, awarded by the American Institute of Electrical Engineers, will go this year to Dr. Harold S. Osborne, retired Chief Engineer of the American Telephone and Telegraph Company.

Dr. Osborne, now a consultant with the International Electro-technical Committee, was cited "for his contributions to the art of telecommunication and his leadership and vision in expending its application; for his achievements in the coordination of international communications and in national and international standardization; and for his advancement of the engineering profession."

NBS Retards Time Signals

NBS has retarded (Jan. 1) the WWV and WWVH time signals by 5 msec.

At the same time, WWV has resumed broadcasting a special timing code which gives the day, hour, minute, and second, coded in binary form.

U. S. Trade Center Will Open in London in Spring

The U. S. Dept. of Commerce, in collaboration with the Department of Agriculture, will open a permanent U. S. trade center (this spring) in London. The new center will be a "showcase for American goods." Attractive display facilities available at no cost to the exhibitor, and backed by aggressive promotion on the part of joint Gov-

ernment-industry teams will provide a "sales package" for American products.

Participating firms exhibiting manufactured goods are expected to underwrite packing, shipping, and insurance costs to the display point. Producers or exporters interested in the new trade promotion center should write to the Office of Trade Promotion, Bureau of Foreign Commerce, U. S. Department of Commerce, Washington 25, D. C.

SINGLE CRYSTAL SILICON



Doped hyper-pure, silicon rod, from Dow Corning Corp., Midland, Mich., being tested for linear resistivity. Single crystal silicon doped to specific requirements, can be supplied. Diameters up to 26 mm and lengths to 360 mm are available.

Need More Colleges Says L. Berkley Davis

The President of the Electronic Industries Assoc., L. Berkley Davis, told the Joint Alumni Council of Kentucky that more college construction programs will be needed in the next ten years than were completed in the U. S. in the last 300 years.

By 1970, the capital required for new buildings and equipment is expected to exceed \$10 billion. College enrollment will approach 7,000,000. Pres. Davis estimated the annual requirements of American colleges in 1970 at \$5 billion.

A BETTER WAY—CREATED BY NCR

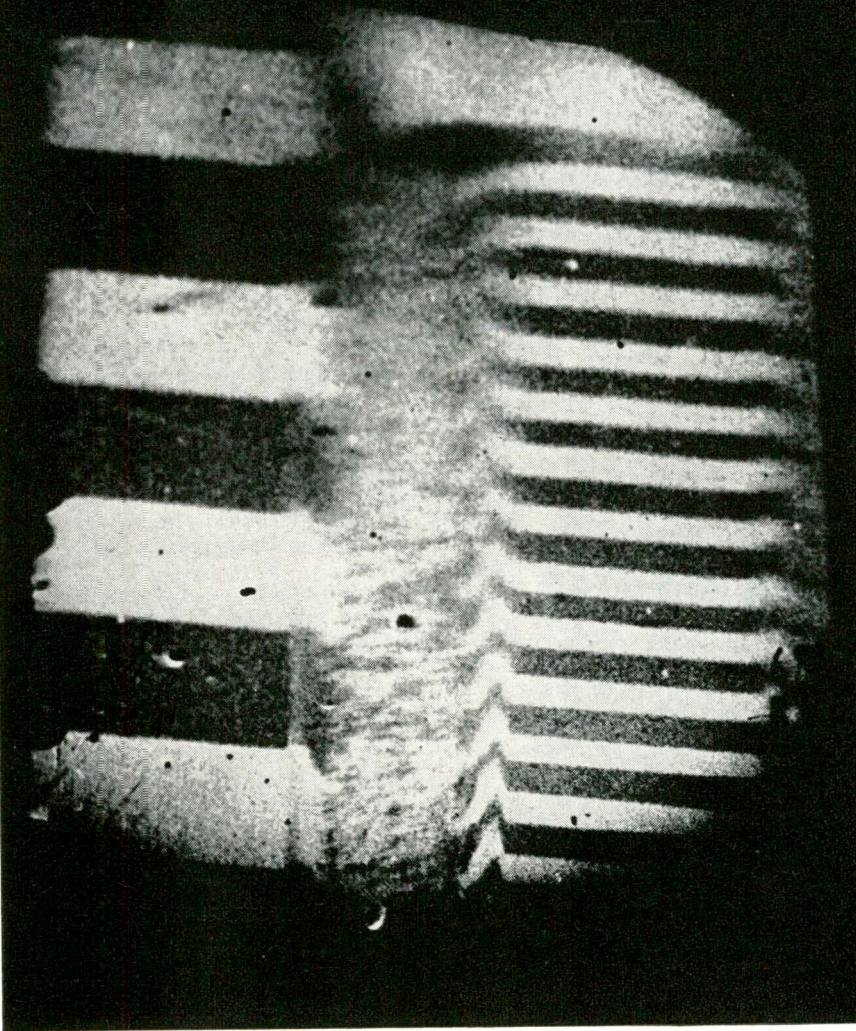

Photomicrograph of magnetically recorded pattern, taken with polarized light, compares readout capability of present systems (left) and NCR MAGOP unit (right).

Engineering Problem: Increase Digital Readout Capability 2500%

The big problem in achieving higher storage densities in magnetic disc or drum memories is not one of getting information in, but one of reading it out.

Although impressive densities have been attained in the laboratory, present magnetic readout devices are incapable of resolving the recorded data. Separation between the reading head and the data surface results in increased loss, while contact between head and surface usually causes serious wear.

Sidestepping the apparent dilemma, NCR Electronics Division engineers have created MAGOP, a developmental system that reads magnetic data optically. In MAGOP, a beam of plane-polarized light responds to the surface magnetization of the disc or drum,

enabling the system to read out five times as much linear information (25 times as much per area) as present magnetic equipment.

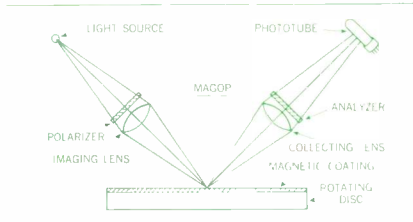

Like most NCR projects, MAGOP involves a combination of scientific disciplines. To the man of extraordinary capabilities—the man who is not content to think in narrow channels—the Electronics Division offers unusual professional and personal rewards.

DIGITAL COMPUTER ENGINEERS— COMMERCIAL EXPANSION AT NCR CREATES OPENINGS IN LOS ANGELES FOR:

COMPUTER ENGINEERS Seniors & Intermediates

Experienced graduate E.E.'s with 3 to 5 years in logic design and transistorized circuit design of digital equipment. Assignments will entail logic and circuit design of buffer storage units and digital peripheral equipment.

TRANSISTOR CIRCUIT ENGINEERS Seniors & Intermediates

Highly creative positions are available in circuit analysis and design. Duties include: advanced mathematical studies in transistor circuitry, evaluation of transistor circuitry, component studies and keeping abreast of computer circuit advances. Circuit analysis ability and solid understanding of transistor theory essential. E.E. degree required.

PRODUCT ENGINEERS Seniors & Intermediates

Assignments entail design analysis and technical liaison to develop a producible product; establishment of design requirements from a standpoint of cost, product ability and standardization; recommendation of changes for ease of manufacture. Positions require substantial knowledge of manufacturing methods, practices, shop equipment and facilities; solid background in electronic design of digital equipment; E.E. degree.

SYSTEMS ENGINEER

Experience required in formulating functional design specifications for digital computer systems (buffer storage, punch card, paper tape, magnetic tape, random access devices, system organizations, command structures). Training in logical design, data-handling methods and programming techniques desirable. Assignments entail formulating functional specifications for business computers.

SYSTEMS TEST ENGINEERS

A responsible position entailing co-ordination of scheduling and utilization of both unit and systems test programs. Originate and analyze test requirements; supervise testing and analysis; recommend changes in design specifications and requirements. Determine validity of test data. Requires E.E. degree plus good knowledge of mechanical engineering, instrumentation, and design engineering.

TRANSISTOR POWER SUPPLY ENGINEER

For assignment in specifying power supplies for both large and small digital systems, supervising the design of supplies internally or by vendors, and evaluating supplies to determine conformance to specifications. Requires knowledge and design experience in solid state computer power supplies, their specification, and associated transistor circuitry. Requires experienced graduate E.E. or man with formal training and appreciable practical transistor power supply experience.

Please submit resume to
Norval E. Powell, Personnel Manager

National*

The National Cash Register Company
ELECTRONICS DIVISION
1401 E. El Segundo Blvd.
Hawthorne (Los Angeles), California
PL 7-1811

*TRADEMARK REG. U.S. PAT. OFF.

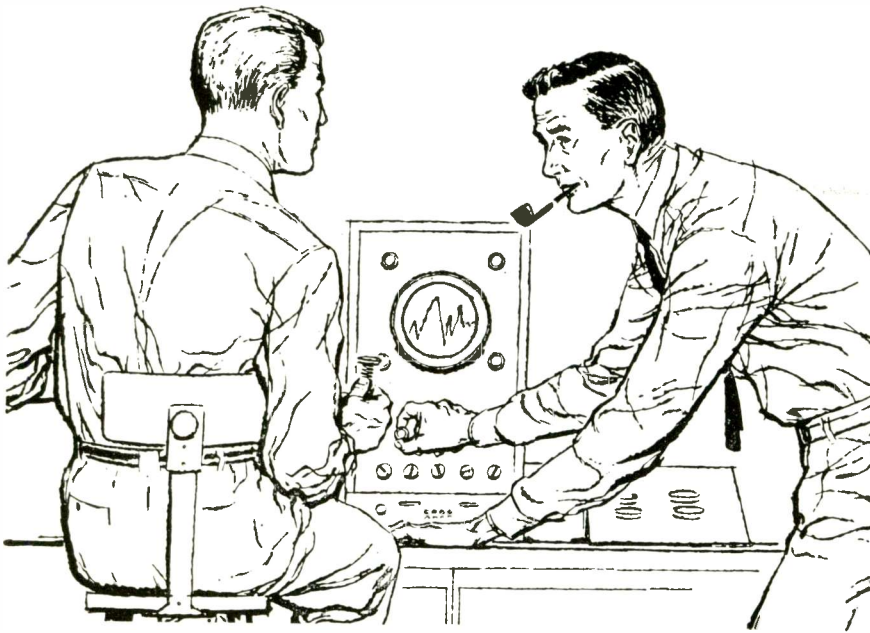

REWARDING!

A feeling of accomplishment, comfortable salary, security, fine home, prestige in the community. Yes, these are the marks of a successful Motorola engineer in Chicagoland. But, what exactly makes a career at Motorola so rewarding—beyond the ordinary realm of material benefits?

Foremost is opportunity. For here a man is encouraged to use all of his creative talents to their fullest. He works on projects that spark vision, that inspire imagination. He works with men who recognize and respect his abilities . . . a calibre of men that he cannot help but admire.

Yes, a career at Motorola is deeply rewarding. You owe it to yourself to discover *exactly* how much. Simply clip the coupon below.

- Radar transmitters and receivers
- Radar circuit design
- Electronic countermeasure systems
- Military communications equipment design
- Pulse circuit design
- IF strip design
- Device using klystron, traveling wave tube and backward wave oscillator
- Display and storage devices
- 2-WAY RADIO COMMUNICATIONS
- VHF & UHF receiver
- Transmitter design and development
- Power supply
- Systems engineering
- Antenna design
- Selective signaling
- Transistor applications
- Crystal engineering
- Sales engineering
- Design of VHF & UHF FM communications in portable or subminiature development
- Microwave field engineers
- Transistor switching circuit design
- Logic circuit design
- T.V. circuit design engineering
- Home radio design
- New product design
- Auto radio design
- Mechanical engineering
- Semi-conductor device development
- Semi-conductor application work

**Also Splendid Opportunities in:
Phoenix, Arizona and Riverside, California**

Send Complete Resumé to:

MR. W. H. HAUSMANN
Engineering Personnel Mgr.
Dept. C
4545 Augusta Blvd.
Chicago 51, Illinois



MOTOROLA Inc.



News of Mrs'

Representatives

REPRESENTATIVES WANTED
Microwave instruments and test equipment manufacturer is seeking representatives. Respondents should include background in this particular field. (Write to: Editor, Electronic Industries, Box 2-1)

Dan R. Bittan has announced that his company has changed from a sole proprietorship to a corporation. New name is D. R. Bittan Co., Inc., 104 South Central Ave., Valley Stream, L. I., N. Y.

General Electrodynamics Corp., Garland, Tex. has appointed three new manufacturers representatives: Nelson Thomas & Assoc., New Orleans, La., will cover Southern and Southwestern states of Arkansas, Alabama, Mississippi, Florida, Georgia, Tennessee, Oklahoma, Louisiana, and Texas. Videonics, Cambridge, Mass. will cover Pennsylvania, New York, Vermont, New Hampshire, Maine, Massachusetts, Connecticut, Rhode Island and New Jersey. Pelco Sales, Inc. will cover California, Oregon, Washington, Idaho, Nevada, New Mexico, Arizona, Utah, Colorado, Wyoming and Montana.

Semicon, Inc., Bedford, Mass., has appointed the Montclair Electronics International Inc., New York, as its exclusive export sales agents in western Europe, Far East, Mid East and South America.

National Connector Corp., Minneapolis, Minn., has named the T. Kennedy Co., Wakefield, Mass., as its engineering sales representatives in the New England states.

Western Semiconductors Inc., Santa Ana, Calif. has appointed 11 new national sales representatives to handle its silicon diode line. They are: Electromek Sales Engineering, No. Syracuse, N. Y.; Connecticut Sales Engineering Co., New Haven, Conn.; Willgold Electronics Sales Corp., Rockville Center, N. Y.; Robert M. Kaiser Co., Dayton Ohio; Industrial Electronic Sales Co., Birmingham, Mich.; Inland Assoc., Clayton, Mo.; Morton L. Friedman Co., Chicago, Ill.; Inland Assoc., Mission, Kans.; Inland Assoc., Lakewood, Colo.; L. A. Nott & Co., San Francisco, Calif.; Norton Electric Wholesale Mart, Los Angeles, Calif.

Lumen, Inc., Joliet, Ill. has appointed S.A.M. Assoc., Jamaica, N. Y. as its representative in the New York metropolitan area covering northern New Jersey, New York City, Long Island, Westchester and Dutchess Counties.

Silicon Transistor Corp., Carle Place, N. Y. has appointed two manufacturers' representatives: McLoud & Raymond, Denver, Colo., to cover the Rocky Mountain area and Logan & Stone Co., San Francisco, Calif., for the northern California territory.

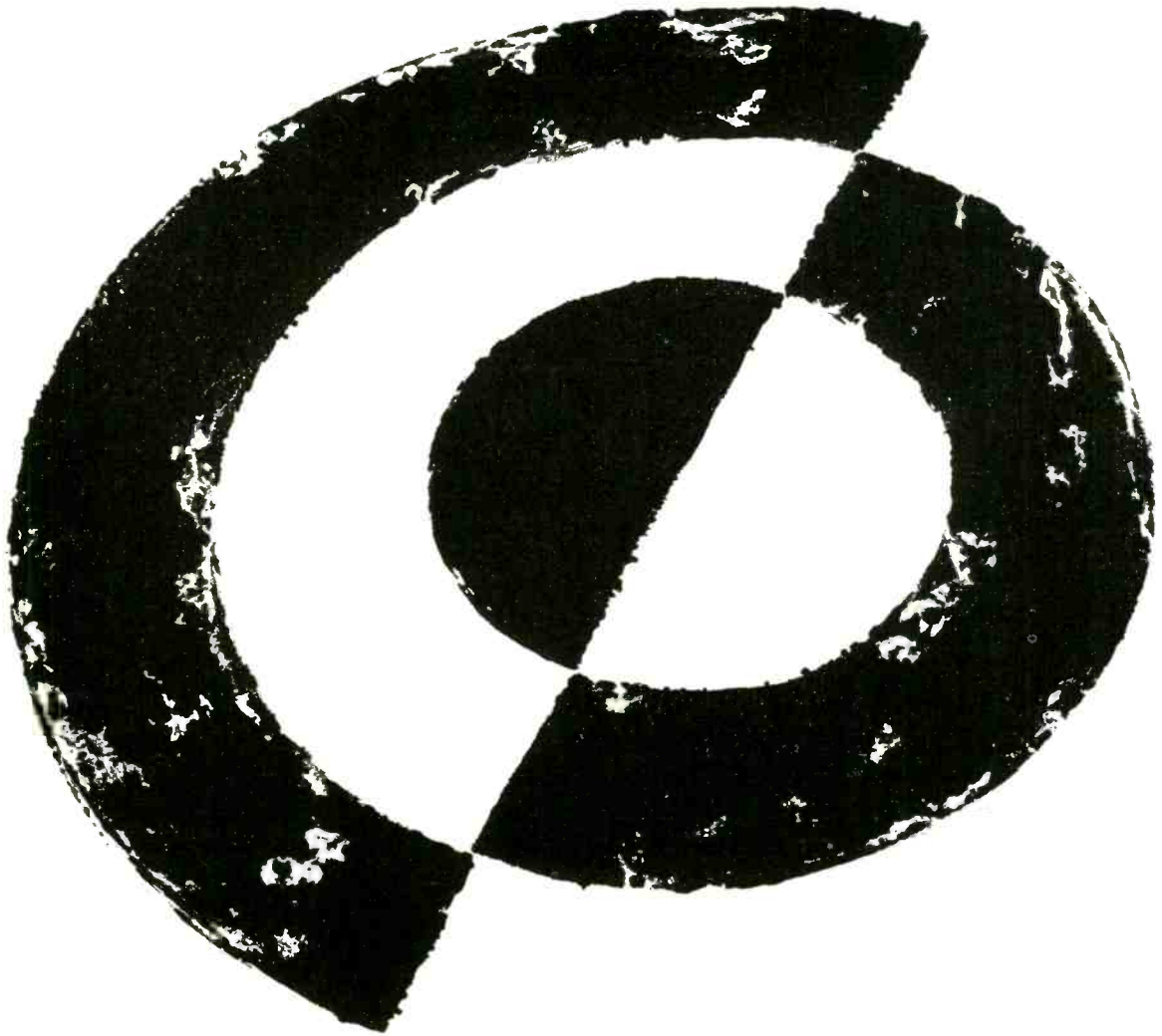

Said J. Stefan and L. Boltzmann: *"The total radiation from a black body is proportional to the fourth power of the absolute temperature of the black body."*

Radiation is usually associated with high temperatures. Yet very cold bodies emit a radiation which can be highly significant in missile and space applications. The problem faced by infrared scientists, trying to detect variations in radiation from low temperature atmospheres, can be likened to detecting a one-foot cube of ice from a distance of five miles.

Lockheed Missiles and Space Division scientists are deeply engaged in studying the problems of infrared emission from the earth and its atmosphere, as seen from orbital altitudes. Although the earth resembles a black body at 300° Kelvin, the emission from its atmosphere, under some circumstances, is much colder. To make measurements under these circumstances, Lockheed has evolved radiometric equipment with one of the most sensitive detection systems yet conceived.

Scientists and engineers must also take careful measurements of a potential employer. Lockheed Missiles and Space Division in Sunnyvale and Palo Alto, California, on the beautiful San Francisco Peninsula, invites this close scrutiny. As Systems Manager for the DISCOVERER and MIDAS satellites and the POLARIS FBM, Lockheed preeminence in Missiles and Space creates positions in many disciplines for outstanding engineers and scientists.

Why not investigate future possibilities at Lockheed? Write Research and Development Staff, Dept. M-13G, 962 West El Camino Real, Sunnyvale, Calif. U.S. citizenship or existing Department of Defense industrial security clearance required.

Lockheed / **MISSILES AND SPACE DIVISION**

Systems Manager for the Navy POLARIS FBM and the Air Force AGENA Satellite in the DISCOVERER and MIDAS Programs

SUNNYVALE, PALO ALTO, VAN NUYS, SANTA CRUZ, SANTA MARIA, CALIFORNIA • CAPE CANAVERAL, FLORIDA • HAWAII

FEEDBACK CONTROL...



IN ULTRASONIC CLEANING?

Sure! Powertron's Autosonic cleaner uses feedback control the way missile guidance systems do—to ensure maximum reliability and efficiency. Feedback control keeps the Autosonic electronically tuned to peak cleaning efficiency, and makes it genuinely self-tuning. Anyone who can flip a switch can use an Autosonic. What's more—the Autosonic is guaranteed to clean almost anything better, cheaper, and faster than other ultrasonic cleaners.

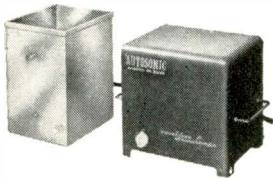

A complete line of Powertron Autosonic cleaners is available from 2 gals. to 75 gals.—from 100 watts to 3000 watts—from \$395 to \$6,000.

A ten-minute demonstration in your own plant will show you what feedback control can do for your ultrasonic cleaning problems. Just check your cleaning problems and send in this coupon and Powertron will do the rest.

- | | |
|--|--|
| <ul style="list-style-type: none"> <input type="checkbox"/> Cleaning <input type="checkbox"/> Electrical assemblies <input type="checkbox"/> Mechanical assemblies <input type="checkbox"/> Circuit boards <input type="checkbox"/> Laboratory glassware <input type="checkbox"/> Surgical instruments <input type="checkbox"/> Engine parts <input type="checkbox"/> Ceramic components <input type="checkbox"/> Metal parts <input type="checkbox"/> Other | <ul style="list-style-type: none"> <input type="checkbox"/> Removing <input type="checkbox"/> Buffing compounds <input type="checkbox"/> Shop dirt <input type="checkbox"/> Fluxes <input type="checkbox"/> Waxes and oils <input type="checkbox"/> Degreasing <input type="checkbox"/> Brightening <input type="checkbox"/> Radioactive contamination <input type="checkbox"/> Other (please describe) |
|--|--|

Check here if you'd like a free copy of our technical bulletin, "How to Clean Ultrasonically with Self-tuning."

Name.....
 Title.....
 Company.....
 Address.....

Write Dept. EI-2

POWERTRON
ULTRASONICS CORP.
 PATTERSON PLACE • ROOSEVELT FIELD
 GARDEN CITY, L.I., NEW YORK • PIONEER 1-3220

Circle 47 on Inquiry Card

News of Mfrs' Representatives

Burnell & Co. has appointed Electronic Component Sales Corp., Orlando, as Florida representative.

R. F. Products, Div. of Amphenol-Borg Electronics Corp., Danbury, Conn., has appointed the following field sales representatives: R. G. Bowen Co., Inc., Denver, Colo.; L. M. DeVoe Co., Indianapolis, Ind.; and Gassner & Clark Co., Chicago, Ill. Also, Fred B. Hill Co., Minneapolis, Minn.; John M. McCune Co., for Florissant, Mo.; R. C. Nordstrom Co., Birmingham, Mich.; Richard Purinton, Inc., Lexington, Mass.; and H. A. Roes & Co., Kansas City, Mo.

Penta Laboratories, Inc., Santa Barbara, Calif. has appointed Elsner-Osborn, Los Angeles, Calif., as its power and special purpose electron tubes representative in Arizona, California and Nevada.

Astro-fab, Inc., Wooster, Ohio, has appointed Einarsen Assoc., River Vale, N. J. as manufacturers' representatives for the Middle Atlantic states.

The Potter Co., No. Chicago, Ill. has appointed the George W. Ledbetter organization as manufacturers' representative. Ledbetter will serve California, Oregon and Washington.

INSTRUMENT DISPLAY VAN



McCarthy Associates, Inc., Pasadena, Cal., Manufacturer's Representatives, will be exhibiting electronic instruments in this new van. It will be on the road nine months of this year, in California, Arizona, and Nevada.

Brimberg Assoc., Washington, D. C., is now manufacturers' representative for Scanwell Laboratories, Inc., Springfield, Va.

James Electronics Inc., has appointed Don L. Mauer Co., Evanston, Ill. as their representative for the State of Wisconsin.

Kollsman Motor Corp., Dublin, Pa., has appointed William W. Weiss, New York City, as manufacturers' representative for metropolitan New York area.

Daniel Woodhead Co., Chicago, Ill., has appointed the J. B. Gleason Co. as their representative for Maine, New Hampshire, Vermont, eastern Massachusetts and Rhode Island.

Designers of Military and Other Precision Applications of Flat Conductor Cable now use . . .

POS-E-KON Trademark SOLDERLESS CONNECTORS

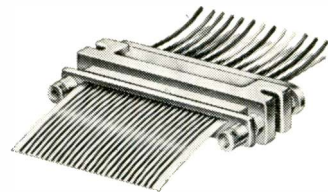

Flat Conductor Cable to Round Wire



Flat Conductor Cable to Flat Conductor Cable

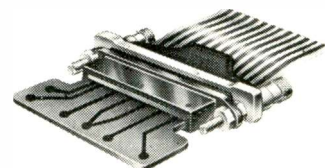

Flat Conductor Cable to Printed Circuit Board

Reliable POS-E-KON connectors feature direct conductor contact—easy assembly—reduced weight and bulk. Standard designs available now for interconnecting or terminating flat multi-conductor cable or flexible printed circuitry. Write to The POS-E-KON Division, The Thomas & Betts Co., Elizabeth 1, N. J. (In Canada, Thomas & Betts Ltd. Montreal).

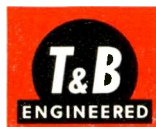

THOMAS & BETTS

Circle 99 on Inquiry Card



More than 4,000 engineers have already taken LMED's* self-appraising technical tests! *Have you?*

Whether you're thinking about a change, or simply interested in finding out how you stack up against other engineers in your field, LMED's Technical Tests will give you a sound means for appraising your abilities—right in your own home.

Carefully designed and pre-tested by LMED engineers, these technical quizzes are meant to be taken and scored for your self-appraisal only. The results need never be divulged to anyone—including Light Military.

Individual tests are available for the fields of Radar, Microwave, Communications, Electronic Packaging

(ME), and Engineering Administration (a self-scoring psychological questionnaire).

Just check your fields of interest below, and we'll send you the corresponding tests, answer sheets and evaluation guides. They'll give you an objective basis for determining the probabilities of your success at Light Military—*before you even consider making application.*

MAIL THIS COUPON FOR YOUR TESTS

Current Areas of Activity At The Light Military Department

Space Communications & Telemetry • Missile & Satellite Computers • Space Vehicle Guidance • Undersea Warfare Systems • Thermoplastic Data Storage • Space Detection & Surveillance • Command Guidance & Instrumentation • Infrared Missile Applications.



* LIGHT MILITARY ELECTRONICS DEPARTMENT

GENERAL ELECTRIC

FRENCH ROAD, UTICA, NEW YORK

Mr. R. Bach
Light Military Electronics Dept. 24-MB
General Electric Company, French Road, Utica, New York

Please send me tests (limited to 2 subjects per individual) answer and self-evaluation sheets covering the areas checked:

- RADAR MICROWAVE
 ELECTRONIC PACKAGING (ME)
 COMMUNICATIONS ADMINISTRATIVE ENGINEERING

Name _____

Home Address _____

City _____ Zone _____ State _____

Home Phone _____

Degree(s) _____ Year(s) Received _____

MOLDED CHOKE COILS



ACTUAL SIZE
10,000 UH

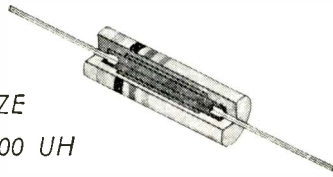

Nicknamed the "Micro Mite", these reliable, rugged coils exhibit high Q, very low distributed capacity, all concentrated into an amazingly small package.

Miller's new "Micro Mite" coils are perfect for use where weight, space and high Q considerations are involved. Their volumetric reduction ranges up to 80%, with current ratings approximately 75-300 millamps and standard series values up to 10,000 uh.

The "Micro Mite" coil construction permits miniaturization without the use of ferrite materials, thus maintaining temperature stability to 125° C. These hermetically sealed molded coils conform to MIL-C-15305A.

ASK FOR OUR MICRO-MITE BULLETIN

J. W. MILLER COMPANY • 5917 So. Main St., Los Angeles 3, Calif.

Circle 100 on Inquiry Card

Industry News

Warren B. Riley—appointed to new post as Director of Marketing and Commercial Product Planning, The Bendix Corp., Detroit, Mich.

J. Penn Rutherford— to newly created position as Director of Licensing, Raytheon Co., Bedford, Mass.

Robert C. Dunlap, Jr.—elected Vice President, Texas Instruments Incorporated, Dallas, Tex.

Donald M. Halliday—Director of Industrial Relations, Lockheed Electronics Co., Plainfield, N. J.



Dr. M. Halliday

Dr. E. A. Guillemin

Dr. Ernst A. Guillemin — named Vice President and Director of Research, Burnell & Co., Inc., Pelham Manor, N. Y.

James R. Carrouth — named to Manager, Houston Fearless Corp.'s Westwood Div. office in Boston, Mass. and Dave H. Phillip joins company as Controller of Westwood Div.

Jacque L. Wilson—named General Manager, Inland Graphite Div., Vitramon, Inc., Bridgeport, Conn.

Winton S. Smith—elected to newly created Vice-Presidency, Marketing and Eugene T. Ferraro as Vice President of Customer Services, Kearfott Div., General Precision, Inc., Little Falls, N. J.

Wes A. Spomer—appointed Production Manager and Russell F. Carr appointed Production Control Manager, Babcock Relays, Inc., Costa Mesa, Calif.

Norman J. Regnier—named Manager of Military Relations, International Rectifier Corp., El Segundo, Calif.

Henry M. DeRosa—appointed Vice President in Charge of Marketing, Vector Mfg. Co., Inc., of Southampton, Pa.

Theodore R. Sheron — appointed Sales Manager, Hitemp Wires Co., Westbury, N. Y.

RONDO

"the pack with the built-in shock absorber"

This Unique System holds small delicate components by the spring-clip action of its fluted partitions and offers: **PROTECTION** in handling and shipping, **FACILITY** in production, storage and inventory, **CONVENIENCE** at receiver's end, **ECONOMY** in all phases. Holds objects from $\frac{3}{16}$ " to $1\frac{1}{4}$ " in diameter.

ANTI-TARNISH BOARD SUPPLIED
Further information on request.

RONDO process and designs patented in all major countries.

RONDO IS A PAPER PRODUCT SOLD AT PAPER PRICES.

RONDO OF AMERICA INC.
100 E SANFORD STREET, HAMDEN 14, CONN.



Representatives: C. S. Shotwell, 527 S. Alexandria Ave., Los Angeles 5, Cal., Phone: DUnkirk 8-8879
Package Development Corp., 5847 N. 95th St., Milwaukee 18, Wisc., Phone: HOpkins 4-3600

PUT YOUR NEW PLANT IN THE
CENTER

.. FAST GROWING CALIFORNIA

FRESNO COUNTY

CALIFORNIA

Equidistant from SF and LA, progressive Fresno County has thousands of acres of excellent sites available for industries. Easy access to all markets is attained with a network of highways, railways, and airports able to handle the largest jets.



FRESNO COUNTY

ASSN. OF CHAMBERS OF COMMERCE
1715 NINTH STREET
REEDLEY, CALIFORNIA

BIOLA • CENTRAL SIERRA • CLOVIS • COALINGA • FIREBAUGH • FOWLER
FRESNO • HURON • KERMAN • KINGSBURG • ORANGE COVE • REEDLEY
• SANGER • SAN JOAQUIN • SELMA • SHAVER-HUNTINGTON LAKES

Circle 38 on Inquiry Card

SAVE DOLLARS

on
ELECTRICAL ENCLOSURES

with

McKINSTRY NEMA Type 1 Panel Enclosures

McKINSTRY NEMA Type 1 General Purpose Enclosures provide perfect protection at lower cost for electrical and electronic controls not requiring the dust and oil tight features of the McKINSTRY NEMA Type 12 Panel Enclosures. These rugged enclosures are made of bonded sheet and have a baked white enamel interior and zinc chromate exterior.

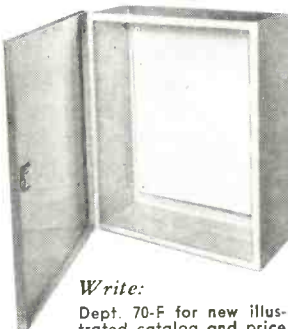

Write:

Dept. 70-F for new illustrated catalog and price list on complete line of McKINSTRY Enclosures and Fittings.

M M W
McKINSTRY METAL WORKS, INC.
285 McKinstry Ave. • Chicopee, Massachusetts

Circle 39 on Inquiry Card

Pin Size SOLENOIDS

... deliver gallons of power

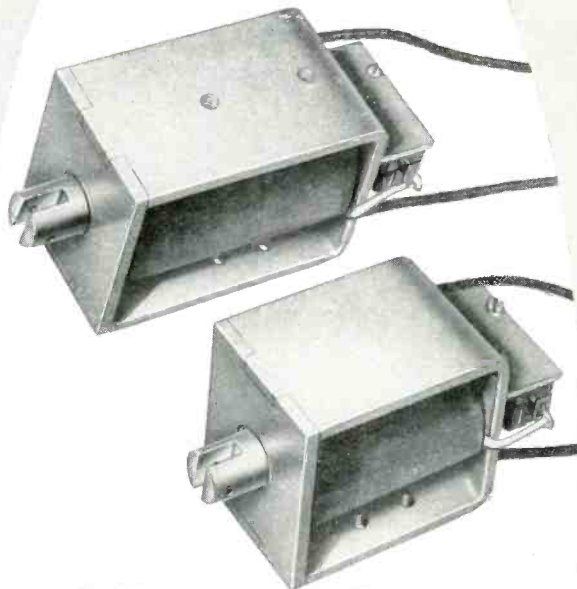

Power Surge Solenoids

with LCD (Low Current Draw)

- Develop as much force as solenoid 2 or 3 times as large
- Continuous duty rating

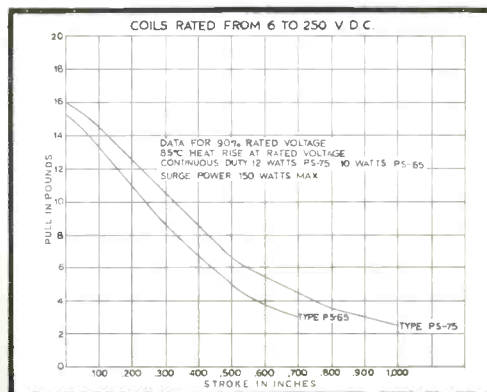

Send for complete technical information and data on **PS** series solenoids.

SOLENOIDS • COILS • ELECTRICAL COMPONENTS
anderson controls, inc.
9959 Pacific Avenue
Franklin Park, Illinois

TWX: FK PK 3573 Phone: GLadstone 1-1210

Circle 278 on Inquiry Card

Now Added to Industry's
Most Complete Line of
Germanium
Power Transistors

NEW CBS



HIGH-POWER



TRANSISTORS

Advantages

- High power output: up to 30 w Class A, 100 w Class B, 1000 w switching
- High voltages . . . high current gains . . . and high working currents
- Low-distortion ring emitter construction
- Hermetically welded JEDEC TO-36 male industrial case

Characteristics

All these CBS high-power transistors have: Max. dissipation, 150 watts* for a typical thermal resistance of 0.5° C/W; max. collector current, 15 amperes; junction temperatures, -65 to +100°C.

Type	Max. W. Diss.*	Max. Thermal Res°C/W	Max. V _{CEO}	Max. V _{CEs}	h _{FE} (I _C = 5A)	
					Min.	Max.
2N173	70	1.0	60	50	35	70
2N174	85	0.8	80	70	25	50
2N277	70	1.0	40	40	35	70
2N278	70	1.0	50	45	35	70
2N441	70	1.0	40	40	20	40
2N442	70	1.0	50	45	20	40
2N443	70	1.0	60	50	20	40
2N1100	85	0.8	100	80	25	50

*25°C base mounting temperature.

save costs • space • weight

You can now replace two 40-watt or four 20-watt paralleled power transistors with one CBS PNP high-power transistor. This one design change brings you important transistor . . . component . . . assembly . . . space . . . and weight savings. New economies become possible in power supplies and amplifiers and in high-power switching circuits.

Note the wide line of these CBS PNP high-power transistors, their pertinent characteristics and many advantages. Ask for complete technical data. Order these money-saving units today . . . at factory prices for quantities up to 1000 . . . from your Manufacturers Warehousing Distributor.



semiconductors

Reliable products through Advanced Engineering

CBS ELECTRONICS, Semiconductor Operations, Lowell, Mass. • A Division of Columbia Broadcasting System, Inc.

Sales Offices: Lowell, Mass., 900 Chelmsford St., GLEnview 2-8961 • Newark, N. J., 231 Johnson Ave., TA1bot 4-2450 • Melrose Park, Ill., 1990 N. Mannheim Rd., EStebrook 9-2100 • Los Angeles, Calif., 2120 S. Garfield Ave., RAymond 3-9081 • Atlanta, Ga., Cary Chapman & Co., 600 Trusco Way, S. W., PLaza 8-4506 • Minneapolis, Minn., The Heimann Co., 1711 Hawthorne Ave., FEderal 2-5457 • Toronto, Ont., Canadian General Electric Co., Ltd., LEnnox 4-6311

Industry News

Everett M. Mason—appointed Purchasing Agent, EMCOR, Ingersoll Products Div., Borg-Warner Corp., Elgin, Ill.

Jack K. Walker—joins Packard Bell Electronics Corp. as Director of Product Planning for the Defense and Industrial Group, Los Angeles, Calif.

John H. Leutwiler—appointed Marketing Manager, Sperry Microwave Electronics Co., Clearwater, Fla.



J. H. Leutwiler



L. Bossert

Lewis Bossert—appointed Manager of Magnetics Marketing, Magnetics Div., Wilcox Electric Co., Kansas City, Mo.

Thomas P. Clements—promoted to Sales Manager, Distributor Div., Hickok Electrical Instrument Co., Cleveland, Ohio.

Clayton Kiernan—appointed National Distributor Sales Manager, Semiconductor Div., The General Instrument Corp., Newark, N. J.

Thomas T. Carey—appointed Market Manager of DC Capacitors and Raymond F. Swoish as Market Manager of AC Capacitors, Aerovox Corp., New Bedford, Mass.

Francis H. Anderson—appointed Superintendent of El Segundo, Calif. works of Allied Chemical, General Chemical Div.

John H. Dummer—assumes duties as Director of Foreign Operations and Affiliates, International Resistance Co., Phila., Pa.

William S. Diefenbach—joins Philco Corp.'s Research Div., Phila., Pa. as Personnel Manager.

Dr. Henry Swift—appointed Assistant Director of the Infrared Laboratory, Hughes Aircraft Co.'s Santa Barbara Research Center.

Herbert D. DeBorde—appointed Director of Manufacturing, Burroughs Corp., Detroit, Mich.

John L. Heins—joins Servo Corp. of America as Director, Defense Systems.

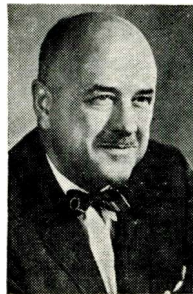

J. L. Heins



Dr. N. A. Finkelstein

Dr. Nisson A. Finkelstein—appointed Vice President in Charge of Research, Stromberg-Carlson Div. of General Dynamics Corp., Rochester, N. Y.

Franc M. Ricciardi—named Planning Vice President, Monroe Calculating Machine Co., Div. of Litton Industries, Beverly Hills, Calif.

Jack Magarian—joins Fairchild Semiconductor Corp., Mountain View, Calif. as Production Control Manager.

H. J. Elias—named Manager of Signal Diode Manufacturing, General Electric Co.'s newly formed Signal Diode Project, Semiconductor Products Dept., Syracuse, N. Y.

WAVE GUIDE PERFECTION

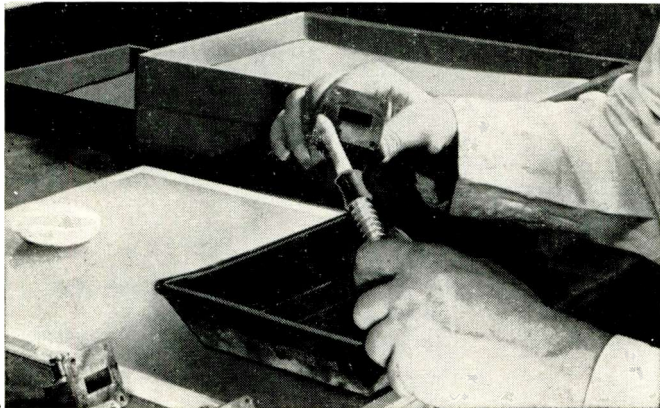

WITH

SELECTRON PLATING

- Selectron Silver Plating recovers scratched flange areas.
- Selectron cadmium or indium plating provides a pressure gasket for fine alignment, while improving corrosion resistance.
- Selectron lead-tin plating simplifies soldering to aluminum wave guides.
- Numerous applications in Electronics and Design. Repair, R & D, and light manufacturing on printed circuits, transistors, capacitors, etc.

Write for 8-page information-packed booklet, Dept. EI-2

• SELECTRONS, LTD.

520 FIFTH AVENUE, NEW YORK 36, N. Y. Yukon 6-8388

Circle 284 on Inquiry Card

How To Get Things Done Better And Faster

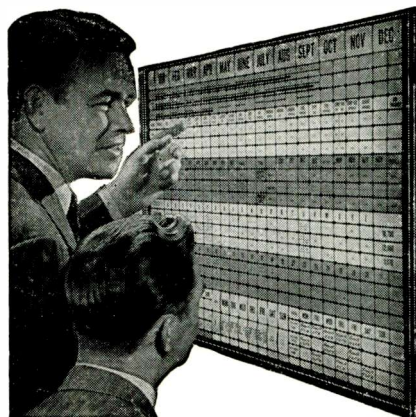

BOARDMASTER VISUAL CONTROL

- ☆ Gives Graphic Picture—Saves Time, Saves Money, Prevents Errors
- ☆ Simple to operate—Type or Write on Cards, Snap in Grooves
- ☆ Ideal for Production, Traffic, Inventory Scheduling, Sales, Etc.
- ☆ Made of Metal. Compact and Attractive. Over 500,000 in Use.

Full price **\$49⁵⁰** with cards

FREE

24-PAGE BOOKLET NO. Z-30
Without Obligation

Write for Your Copy Today
GRAPHIC SYSTEMS
Yanceyville, North Carolina

Circle 281 on Inquiry Card

flexible power for forward scatter

75 kW CW to 10 kW

The Varian VA-853 CW amplifier klystron features an extremely flexible power range at 755 to 985 Mc — from 75 kW to as low as 10 kW. Provides new possibilities in the development of troposcatter systems.

Designed to meet USAF specifications for forward scatter tubes.

One power amplifier serves the entire output range. Power can be varied easily by adjustment of the beam voltage. Drives from a 5 W exciter. High gain — 50 db — is provided by five internal cavities. Compactly designed, with input and output couplings preset for flat rf lines. Just tune to desired frequency; no other physical adjustments are necessary.

Noncritical electromagnet provides a self-centering mount; the tube can be removed as a unit, inserted directly — no need for roll-out dollies.

*It's very probable Varian power tubes
can aid in your design problem.
For technical information, write Tube Division.*



FEATURES:

- 75 kW CW
- 755-985 Mc
- 50 db Gain
- 7 Mc Bandwidth

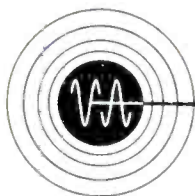

VARIAN associates

PALO ALTO 19, CALIFORNIA

BOMAC LABORATORIES, INC.
VARIAN ASSOCIATES OF CANADA, LTD.
S-F-D LABORATORIES, INC.
SEMICON ASSOCIATES, INC.
SEMICON OF CALIFORNIA, INC.
VARIAN A. G. (SWITZERLAND)

RCA Announces The "TO-1" Rectifier



New Tiny, Rugged,
Tubular, Flangeless,
Hermetically Sealed In
Non-Combustible Metal Case

4 New RCA Silicon Rectifiers for Industrial Applications 3/4 Amp. from 200 to 600v—1/2 Amp. at 800v.

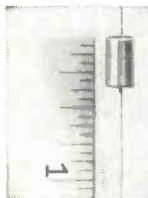

Here's RCA's brand-new idea in rectifier case design—four new silicon rectifiers in hermetically sealed flangeless metal packages. These four new types now make silicon rectifiers as easy to handle and mount as other standard tubular components. They are designed to outperform plastic-packaged rectifiers and meet the stringent heat and humidity requirements of

today's industrial and commercial applications.

Using a unique combination of a silicon diffused-junction and a new case, these units can be operated at temperatures up to 75°C without derating. They are designed and priced to bring you economy and performance plus easy handling and assembly.

Sample these new RCA SILICON RECTIFIERS yourself and put them to work in your product. Call your RCA representative today at the Field Office near you. For additional technical information, write RCA Semiconductor and Materials Division, Commercial Engineering, Section B-50-NN, Somerville, N. J.

Available Through Your RCA Distributor



The Most Trusted Name in Electronics
RADIO CORPORATION OF AMERICA

RCA "TO-1" SILICON RECTIFIERS					
Type	Max Ratings PIV	Max. Ratings Forward Current @ 75°C	Max Ratings Recurrent Peak Current @ 75°C	Max Instantaneous Forward Voltage Drop @ 0.5 DC amp. @ 25°C	Max. Reverse Current @ 25°C and rated PIV
1N3193	200 v	750 ma	6 amp.	1.2 v	10 μ a
1N3194	400 v	750 ma	6 amp.	1.2 v	10 μ a
1N3195	600 v	750 ma	6 amp.	1.2 v	10 μ a
1N3196	800 v	500 ma	5 amp.	1.2 v	10 μ a

*Resistive or inductive load

RCA SEMICONDUCTOR & MATERIALS DIVISION FIELD OFFICES...
EAST: 744 Broad Street, Newark, N. J., HUmboldt 5-3900 • 731 James Street, Room 402, Syracuse 3, New York, GRAnite 4-5591 • **NORTHEAST:** 64 "A" Street, Needham Heights 94, Mass., HILLcrest 4-7200 • **EAST CENTRAL:** 714 New Center Bldg., Detroit 2, Mich., TRinity 5-5600 • **CENTRAL:** Suite 1154, Merchandise Mart Plaza, Chicago, Ill., WHitehall 4-29#0 • P. O. Box 8406, St. Louis Park Branch, Minneapolis, Minn., FEderal 9-1249 • **WEST:** 6355 E. Washington Blvd., Los Angeles, Calif., RAYmond 3-8361 • 1838 El Camino Real, Burlingame, Calif., OXFord 7-1620 • **SOUTH:** Calmar Building, 1520 Edgewater Drive, Suite 1, Orlando, Florida, GArden 4-4768 • **SOUTHWEST:** 7905 Empire Freeway, Dallas 7, Texas, FLEetwood 7-8167 • **GCV'T:** 224 N. Wilkinson St., Dayton, O., BALdwin 6-2366 • 1725 "K" St., N.W., Washington, D.C., FEderal 7-8500.

Technological Leadership in Silicon Rectifiers

